

**QuickDAQ**  
**User's Manual**

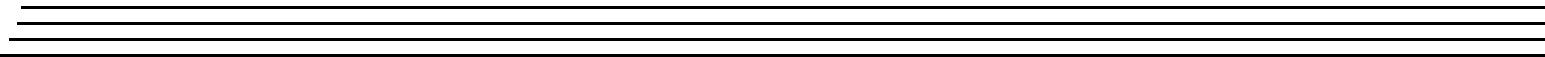
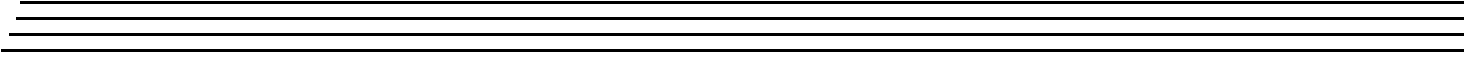
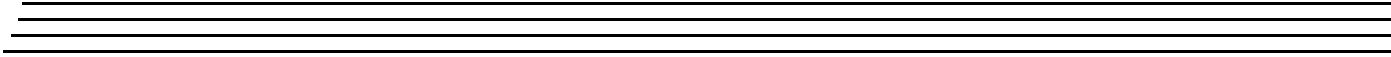

## Trademark and Copyright Information

Measurement Computing Corporation, InstaCal, Universal Library, and the Measurement Computing logo are either trademarks or registered trademarks of Measurement Computing Corporation. Refer to the Copyrights & Trademarks section on [mccdaq.com/legal](http://mccdaq.com/legal) for more information about Measurement Computing trademarks. Other product and company names mentioned herein are trademarks or trade names of their respective companies.

© 2016 Measurement Computing Corporation. All rights reserved. No part of this publication may be reproduced, stored in a retrieval system, or transmitted, in any form by any means, electronic, mechanical, by photocopying, recording, or otherwise without the prior written permission of Measurement Computing Corporation.

### **Notice**

Measurement Computing Corporation does not authorize any Measurement Computing Corporation product for use in life support systems and/or devices without prior written consent from Measurement Computing Corporation. Life support devices/systems are devices or systems that, a) are intended for surgical implantation into the body, or b) support or sustain life and whose failure to perform can be reasonably expected to result in injury. Measurement Computing Corporation products are not designed with the components required, and are not subject to the testing required to ensure a level of reliability suitable for the treatment and diagnosis of people.

---

# Table of Contents

<b>About this Manual</b> .....	<b>15</b>
Intended Audience.....	15
Organization of this Manual.....	15
Conventions Used in this Manual .....	16
Related Information.....	16
Where to Get Help .....	16
<b>Chapter 1: Introduction to QuickDAQ</b> .....	<b>17</b>
Features .....	18
Supported Devices .....	19
Modes of Operation .....	20
Licensing Requirements .....	21
Resolution Requirements .....	23
<b>Chapter 2: Quick Start</b> .....	<b>25</b>
Installing the Software.....	26
Getting Started .....	27
<b>Chapter 3: Understanding the Interface</b> .....	<b>33</b>
Overview of the Interface .....	34
Menus.....	36
File Menu .....	36
New Hpf Data File .....	36
Open Hpf Data File .....	36
Close Hpf Data File .....	37
Export Data .....	37
File Export Dialog for the Data Logger Interface.....	37
File Export Dialog for the FFT Analyzer Interface.....	40
Save Current Plot Image .....	43
Open Current Data in Excel .....	43
Open Current Data in Excel Using the Data Logger Interface.....	43
Open Current Data in Excel Using the FFT Analyzer Interface.....	43
Load Configuration .....	44
Save Configuration .....	44
Open Hpf Data Folder .....	44
Open Export Data Folder .....	44
Page Setup .....	45
Print Preview .....	45
Print .....	45

Exit .....	45
Exit without saving current configuration .....	45
Edit Menu .....	45
Record Menu .....	46
Plot Menu .....	46
Configuration Menu .....	47
Windows Menu .....	48
Mode Menu .....	48
Help Menu .....	49
Toolbar Buttons .....	50
Window Positioning .....	53
Hiding a Window .....	54
Resetting the Window Layout .....	55
Acquisition Config Window .....	56
Acquisition Config Window for the Data Logger Interface .....	56
Acquisition Config Window for the FFT Analyzer Interface .....	59
Plot and Data Config Window .....	65
Plot and Data Config Window for the Data Logger Interface .....	65
Plot and Data Config Window for the FFT Analyzer Interface .....	66
Channel Plot Window .....	68
Setting Up the Y-Axis .....	69
Y Axis Setup .....	69
Zoom to Fit in View .....	70
Zoom to Fit All .....	70
Setting Up the X-Axis .....	70
X Axis Setup .....	71
Zoom to Fit All .....	71
Edit Label .....	71
Pause Tracking .....	72
Resume Tracking .....	72
Using the Channel Plot Window Controls .....	72
Tracking Resume .....	72
Tracking Pause .....	73
Axes Scroll .....	73
Axes Zoom .....	73
Zoom-Out All .....	73
Zoom-In All .....	73
Zoom All to Fit in View Y .....	73
Link X Axes to Selected .....	74
Link Y Axes to Selected .....	74
Link Cursors to Selected .....	74

Select .....	75
Zoom Box .....	75
Data-Cursor .....	75
Copy to Clipboard .....	76
Save Plot Image .....	77
Print .....	77
Preview .....	77
Page Setup .....	77
Show Legend .....	77
Show Data Point Markers .....	77
Zoom Options that Apply to the Current Plot .....	78
Scrolling Options.....	79
Channel Display Window.....	81
Statistics Window.....	82
Statistics in the Data Logger Interface .....	82
Statistics in the FFT Analyzer Interface .....	82
Acquisition Status Window .....	84
Acquisition Status Window When Using the Data Logger Interface .....	84
Acquisition Status Window When Using the FFT Analyzer Interface .....	84
<b>Chapter 4: Configuring Channels, Acquisition Settings, and Digital Filters .....</b>	<b>85</b>
Configuring Channels of a Device.....	86
Enabling Channels .....	89
Channel Name.....	90
Input Type .....	90
Ref/Resp .....	90
Analog Input Channel Settings for Devices that Support Voltage .....	90
Sensor Type .....	90
Range .....	90
Engineering Unit (EU) .....	91
mV/EU .....	91
EU Offset .....	91
Enable Termination Resistor .....	92
Point # .....	92
Analog Input Channel Settings for Devices that Support Thermocouples .....	92
Sensor Type .....	92
Engineering Unit (EU) .....	93
EU Offset .....	93
Point # .....	93
Analog Input Channel Settings for Devices that Support RTDs .....	93
Sensor Type .....	93
Sensor Type Selections for MEASURpoint Instruments.....	93

Sensor Type Selections for the DT9829 and Other DT-Open Layers Devices	94
RTD R0	95
A Coeff	95
B Coeff	95
C Coeff	96
Sensor Wiring	96
Engineering Unit (EU)	96
EU Offset	96
Point #	96
Analog Input Channel Settings for Devices that Support Thermistors	96
A Coeff, B Coeff, and C Coeff	96
Sensor Wiring	97
Engineering Unit (EU)	97
EU Offset	97
Point #	97
Analog Input Channel Settings for Devices that Support Resistance	97
Sensor Type	97
Resistance Range	97
Sensor Wiring	98
Engineering Unit (EU)	98
EU Offset	98
Point #	98
Analog Input Channel Settings for Devices that Support Current	99
Engineering Unit (EU)	99
EU Offset	99
Enable Termination Resistor	99
Point #	99
Analog Input Channel Settings that Support IEPE Inputs	100
Range	100
Coupling Type	100
Current Source	100
Engineering Unit (EU)	100
mV/EU	101
EU Offset	101
Point #	101
Dir	101
Analog Input Channel Settings for Devices that Support Strain Gages and Bridges	102
Enable Shunt Resistor	102
Configuration and Calibration Wizard	102
Parameters for Full Bridge Based Sensors	104

---

Parameters for Strain Gage Sensors . . . . .	108
Parameters for Voltage Based Sensors . . . . .	114
Point # . . . . .	115
Digital Input Settings . . . . .	115
Tachometer Settings . . . . .	115
Engineering Unit (EU) . . . . .	115
Ticks/Rev . . . . .	115
Max RPM . . . . .	115
RPM Multiplier . . . . .	116
Max mSec/Hz . . . . .	116
Tach Edge . . . . .	116
Counter Settings . . . . .	117
Engineering Unit (EU) . . . . .	117
Max mSec/Hz . . . . .	117
Start Edge . . . . .	118
Stop Edge . . . . .	118
Quadrature Decoder Channel Settings . . . . .	119
Engineering Unit (EU) . . . . .	119
Pulses/Rev . . . . .	119
Clock Prescale . . . . .	119
X4 Scaling . . . . .	119
Index Mode . . . . .	119
Applying and Saving Changes . . . . .	120
Configuring the Settings of the Recording Tab . . . . .	121
Recording Tab When Using the Data Logger Interface . . . . .	121
Recording Tab When Using the FFT Analyzer Interface . . . . .	124
Configuring the Settings of the Acquisition Tab (Data Logger Interface Only) . . . . .	127
Sampling Frequency . . . . .	127
Trigger Source . . . . .	128
Filter Type . . . . .	128
Temperature Units . . . . .	129
Single-Ended or Differential Channel Configuration . . . . .	129
Input Voltage Range . . . . .	129
Configuring the Settings of the Freq Tab (FFT Analyzer Interface Only) . . . . .	130
Maximum Frequency to Analyze . . . . .	130
FFT Size . . . . .	131
Single-Ended or Differential Channel Configuration . . . . .	131
Input Voltage Range . . . . .	131
Temperature Units . . . . .	131
Filter Type . . . . .	132
Configuring the Settings of the Trigger Tab (FFT Analyzer Interface Only) . . . . .	133
Trigger Source . . . . .	134

Threshold Trigger Options.....	135
Trigger Mode.....	136
Configuring the Settings of the Window Tab (FFT Analyzer Interface Only).....	137
Window Tab for the FFT Analysis Option.....	137
Window Tab for the Advanced FFT Analysis Option.....	138
Configuring the Settings of the Output Tab.....	140
Enabling Channels.....	142
Channel Name.....	142
Peak Voltage.....	142
Offset.....	142
Waveform Type.....	142
Fixed Waveforms.....	143
Signal Type.....	143
Output Frequency.....	143
Output Mode.....	144
Ramp Up Time and Ramp Down Time.....	144
Example.....	145
Sweep Waveforms.....	146
Sweep Mode.....	147
Frequency Change.....	147
Start and End Frequencies.....	148
Sweep On Time and Sweep Off Time.....	148
Ramp Up Time and Ramp Down Time.....	149
Examples.....	149
Noise Waveforms.....	152
Noise Type.....	153
Output Mode.....	159
Ramp Up Time and Ramp Down Time.....	160
Output Frequency.....	160
Repeat Method.....	160
Start/Stop Methods.....	161
Muting and Unmuting the Output Signal.....	162
Configuring Digital Filters.....	164
Channels and Filter Status Indicators.....	165
Filter Types.....	165
Filter Category and Cutoff Frequency.....	166
Filter Order.....	166
dB Ripple.....	167
Frequency Response Graph.....	167
Impulse Response Graph.....	167
Step Response Graph.....	168



<b>Chapter 5: Configuring the Display of the Data Logger Interface. . . . .</b>	<b>169</b>
Introduction. . . . .	170
Configuring the Appearance of the Channel Plot Window. . . . .	171
Displaying Channels in the Channel Plot Window . . . . .	171
Making All Selected Channels Visible or Hidden in the Channel Plot Window at Once . . . . .	172
Showing or Hiding the Visible Plot Column . . . . .	172
Moving the Visible Plot Column . . . . .	172
Displaying Data Cursors in the Channel Plot Window. . . . .	173
Making All Selected Data Cursors Visible or Hidden at Once . . . . .	173
Showing or Hiding the Show Cursor Column . . . . .	174
Moving the Show Cursor Column . . . . .	174
Specifying the Columns of the Channel Plot Window . . . . .	174
Changing the Plot Column for All Selected Channels at Once . . . . .	175
Showing or Hiding the Plot Column . . . . .	176
Moving the Plot Column . . . . .	176
Grouping Signals in Bands on the Channel Plot Window . . . . .	176
Changing the Signal Group for All Selected Channels at Once . . . . .	177
Showing or Hiding the Signal Group Column . . . . .	177
Moving the Signal Group Column . . . . .	177
Specifying the Trace Color on the Channel Plot Window. . . . .	178
Showing or Hiding the Color Column . . . . .	178
Moving the Color Column . . . . .	178
Controlling How Data is Plotted in the Channel Plot Window . . . . .	179
Specifying the Style of the Plots in the Channel Plot Window. . . . .	181
Configuring the Appearance of the Channel Display Window . . . . .	182
Displaying Channels in the Channel Display Window. . . . .	182
Making All Selected Channels Visible or Hidden in the Channel Display Window at Once . . . . .	183
Showing or Hiding the Visible Display Column . . . . .	183
Moving the Visible Display Column . . . . .	183
Controlling How Data is Displayed in the Channel Display Window . . . . .	184
Specifying the Style of the Channel Display Window. . . . .	186
Configuring the Appearance of the Statistics Window . . . . .	188
Making Statistics for All Selected Channels Visible or Hidden in the Statistics Window at Once . . . . .	188
Showing or Hiding the Visible Statistics Column . . . . .	189
Moving the Visible Statistics Column . . . . .	189
<b>Chapter 6: Configuring the Display of the FFT Analyzer Interface. . . . .</b>	<b>191</b>
Introduction. . . . .	192
Configuring the Appearance of the Channel Plot Window. . . . .	193
Displaying Channels in the Channel Plot Window . . . . .	193

Making All Selected Channels Visible or Hidden in the Channel Plot Window at Once .....	194
Showing or Hiding the Visible Plot Column .....	194
Moving the Visible Plot Column .....	194
Displaying Data Cursors in the Channel Plot Window.....	195
Making All Selected Data Cursors Visible or Hidden at Once .....	195
Showing or Hiding the Show Cursor Column .....	196
Moving the Show Cursor Column .....	196
Specifying the Plot Columns of the Channel Plot Window .....	196
Changing the Plot Column for All Selected Channels at Once .....	197
Showing or Hiding the Plot Column .....	197
Moving the Plot Column .....	197
Grouping Signals in Bands on the Channel Plot Window .....	198
Changing the Signal Group for All Selected Channels at Once .....	199
Showing or Hiding the Signal Group Column .....	199
Moving the Signal Group Column .....	200
Specifying the Trace Color on the Channel Plot Window.....	200
Showing or Hiding the Color Column .....	200
Moving the Color Column .....	200
Controlling How Data is Plotted in the Channel Plot Window.....	201
Specifying the Style of the Plots in the Channel Plot Window.....	202
Adding Channels to the Plot and Data Config Window .....	204
Adding a Single Channel FFT Function to the Channel List .....	205
Adding a Two-Channel FFT Function to the Channel List.....	206
Adding a Windowed Time Domain Channel to the List.....	206
Adding a Time Domain Channel to the List.....	207
Removing Channels from the Plot and Data Config Window .....	208
Configuring Parameters for a Single FFT Channel .....	209
Function Tab.....	209
Spectrum Function .....	210
Integration Type .....	210
Display Function .....	210
Scaling Tab .....	211
Averaging Tab .....	213
Configuring Parameters for a Two-Channel FRF Function .....	215
Function Tab.....	216
FRF Estimator .....	216
Reference Channel .....	216
Display Function .....	216
FRF Mode .....	217
Scaling Tab .....	218

Averaging Tab .....	219
Configuring Parameters for a Two-Channel Cross Spectrum Function. ....	220
Function Tab. ....	220
Cross Function .....	221
Reference Channel .....	221
Resp Integration .....	221
Ref Integration .....	221
Display Function .....	221
Scaling Tab .....	222
Averaging Tab .....	223
Configuring Parameters for a Two-Channel Coherence Function .....	224
Function Tab. ....	224
Coherence Function .....	225
Reference Channel .....	225
Scaling Tab .....	225
Averaging Tab .....	226
Configuring Statistics for FFT Plots Using the Stats Tab .....	227
Scrolling through FFTs for an Analog Input Channel. ....	229
Configuring the Appearance of the Channel Display Window .....	230
Displaying Channels in the Channel Display Window. ....	230
Making All Selected Channels Visible or Hidden in the Channel Display Window at Once .....	231
Showing or Hiding the Visible Display Column .....	231
Moving the Visible Display Column .....	231
Controlling How Data is Displayed in the Channel Display Window .....	232
Specifying the Style of the Channel Display Window .....	234
Configuring the Appearance of the Statistics Window .....	236
Displaying Channels in the Statistics Window .....	236
Making All Selected Channels Visible or Hidden in the Statistics Window at Once .....	237
Showing or Hiding the Visible Statistics Column .....	237
Moving the Visible Statistics Column .....	237
Controlling How Data is Displayed in the Statistics Window .....	237
Showing Dynamic Performance Statistics .....	238
IBF – Input Below Full-Scale .....	239
THD – Total Harmonic Distortion .....	240
SFDR – Spurious Free Dynamic Range .....	242
SINAD – Signal-to-Noise and Distortion Ratio .....	243
SNR – Signal-to-Noise Ratio .....	245
ENOB – Effective Number of Bits .....	246
Showing Min/Max/Mean Statistics .....	246

<b>Chapter 7: Examples Using the Data Logger Interface</b> .....	<b>247</b>
Example of Measuring Temperature and Voltage .....	248
Configure the Channels .....	248
Configure the Parameters of the Acquisition Config Window .....	250
Configure the Appearance of the Channel Display Window .....	252
Configure the Appearance of the Channel Plot Window .....	253
Configure the Appearance of the Statistics Window .....	256
Position the Windows .....	256
Start the Measurement .....	258
Example of Monitoring an Analog Output Signal .....	259
Configure the Analog Output Settings .....	259
Configure the Analog Input Channel .....	261
Configure the Recording Settings .....	263
Configure the Acquisition Settings .....	264
Configure the Appearance of the Display .....	265
Start the Operation .....	266
<b>Chapter 8: Examples Using the FFT Analyzer Interface</b> .....	<b>267</b>
Acceleration Measurement Example .....	268
Configure the Channels .....	268
Configure the Recording Settings .....	270
Configure the Frequency Settings .....	271
Configure the Trigger Settings .....	272
Configure the Windowing Function .....	273
Add FFTs Channel to the Channel Plot Window .....	274
Configure FFT Parameters to Analyze Acceleration Data .....	274
Configure the Appearance of the Channel Plot Window .....	276
Configure Statistics to Analyze Acceleration Data .....	278
Start the Acceleration Measurement .....	279
Perform Further Analysis of the Data .....	280
Impact Testing Example .....	283
Configure the Channels .....	283
Configure the Recording Settings .....	285
Configure the Frequency Settings .....	286
Configure the Trigger Settings .....	287
Configure the Windowing Function .....	288
Add an FFT Channel to the Plot and Data Config Window .....	289
Configure the FFT Channel .....	289
Add an FRF Channel to the Plot and Data Config Window .....	292
Configure the FRF Channel .....	292
Add a Coherence Channel to the Plot and Data Config Window .....	294

Configure the Coherence Channel . . . . .	294
Configure the Appearance of the Channel Plot Window . . . . .	295
Start the Impact Test . . . . .	298
Add Another FRF Channel to the Plot and Data Config Window . . . . .	299
Configure the FRF Channel for Phase . . . . .	299
Configure the Appearance of the Channel Plot Window . . . . .	301
Restart the Impact Test . . . . .	302
Strain Gage Example . . . . .	303
Configure the Channels . . . . .	303
Configure the Recording Settings . . . . .	311
Configure the Frequency Settings . . . . .	312
Configure the Trigger Settings . . . . .	313
Start the Strain Measurement . . . . .	314
Export the Data to Excel . . . . .	315
Bridge-Based Sensor Example . . . . .	316
Configure the Channels . . . . .	316
Configure the Recording Settings . . . . .	324
Configure the Frequency Settings . . . . .	325
Configure the Trigger Settings . . . . .	326
Start the Measurement . . . . .	327
Export the Data to Excel . . . . .	328
Free Run Swept Sine Example . . . . .	329
Configure the Channels . . . . .	329
Configure the Recording Settings . . . . .	331
Configure the Frequency Settings . . . . .	332
Configure the Trigger Settings . . . . .	333
Configure the Windowing Function . . . . .	334
Configure the Analog Output Settings . . . . .	335
Add FFT Channels to the Plot and Data Config Window . . . . .	336
Configure the FFT Channels . . . . .	337
Add FRF Channels to the Plot and Data Config Window . . . . .	339
Configure the FRF Channels . . . . .	339
Add Coherence Channels to the Plot and Data Config Window . . . . .	341
Configure the Coherence Channel . . . . .	342
Configure the Appearance of the Channel Plot Window . . . . .	344
Start the Simultaneous Swept Sine and Analog Input Operation . . . . .	346
Triggered Burst Random Example . . . . .	347
Configure the Channels . . . . .	347
Configure the Recording Settings . . . . .	350
Configure the Frequency Settings . . . . .	351
Configure the Trigger Settings . . . . .	352
Configure the Windowing Function . . . . .	353

Configure the Analog Output Settings .....	354
Add FFT Channels to the Plot and Data Config Window.....	355
Configure the FFT Channels .....	356
Add FRF Channels to the Plot and Data Config Window .....	358
Configure the FRF Channels .....	358
Add Coherence Channels to the Plot and Data Config Window.....	361
Configure the Coherence Channel .....	361
Configure the Appearance of the Channel Plot Window .....	363
Start the Simultaneous Burst Random Output and Analog Input Operation .....	365
Example of Monitoring an Analog Output Signal .....	366
Configure the Analog Output Settings .....	366
Configure the Analog Input Channel.....	368
Configure the Recording Settings.....	370
Configure the Frequency Settings.....	371
Configure the Trigger Settings .....	372
Configure the Windowing Function.....	373
Configure the Appearance of the Statistics Window .....	374
Start the Operation .....	376
Example of Using a Digital Filter.....	377
Configure the Input Channel.....	377
Configure the Recording Settings.....	378
Configure the Frequency Settings.....	379
Configure the Trigger Settings .....	380
Open the Digital Filter Configuration Dialog.....	381
Start the Acquisition.....	382
Configure the Digital Filter Configuration Dialog.....	383
<b>Chapter 9: Support .....</b>	<b>385</b>
Troubleshooting .....	386
Technical Support .....	387
<b>Appendix A: Glossary .....</b>	<b>389</b>
<b>Index .....</b>	<b>401</b>

# ***About this Manual***

The manual describes the features of QuickDAQ, how to get started using QuickDAQ, and how to create a typical application to acquire and analyze data from a data acquisition device.

## **Intended Audience**

This document is intended for engineers, scientists, technicians, or others responsible for acquiring and analyzing measurement data. It is assumed that you are familiar with the Windows operating environment, that you are familiar with measurement principles.

## **Organization of this Manual**

This manual is organized as follows:

- [Chapter 1, “Introduction to QuickDAQ,”](#) provides an overview of the features of QuickDAQ.
- [Chapter 2, “Quick Start,”](#) describes how to install and start QuickDAQ.
- [Chapter 3, “Understanding the Interface,”](#) describes the basic elements of the Data Logger and FFT Analyzer interfaces of QuickDAQ.
- [Chapter 4, “Configuring Channels, Acquisition Settings, and Digital Filters,”](#) describes how to configure the channels and acquisition settings of a supported device using QuickDAQ.
- [Chapter 5, “Configuring the Display of the Data Logger Interface,”](#) describes how to configure the settings of the Channel Plot, Channel Display, and Statistics windows when using the Data Logger interface of QuickDAQ.
- [Chapter 6, “Configuring the Display of the FFT Analyzer Interface,”](#) describes how to configure the settings of the Channel Plot, Channel Display, and Statistics windows when using the FFT Analyzer interface of QuickDAQ.
- [Chapter 7, “Examples Using the Data Logger Interface,”](#) provides step-by-step instructions that you can follow to create applications when using the Data Logger interface of QuickDAQ.
- [Chapter 8, “Examples Using the FFT Analyzer Interface,”](#) provides step-by-step instructions that you can follow to create applications when using the FFT Analyzer interface of QuickDAQ.
- [Chapter 9, “Support,”](#) provides technical support information.

A glossary and index complete this manual.

## Conventions Used in this Manual

The following conventions are used in this manual:

- Notes provide useful information that requires special emphasis, cautions provide information to help you avoid losing data or damaging your equipment, and warnings provide information to help you avoid catastrophic damage to yourself or your equipment.
- Items that you select or type are shown in **bold**.

## Related Information

This manual is intended to be used with the documentation for your data acquisition device.

## Where to Get Help

Should you encounter problems installing or using QuickDAQ, the Data Translation Technical Support Department is available to provide technical assistance. Refer to [Chapter 9](#) starting on [page 385](#) for information on how to contact the Technical Support Department.





# ***Introduction to QuickDAQ***

Features .....	18
Modes of Operation .....	20
Resolution Requirements .....	23

## Features

Three versions of QuickDAQ are available:

- **QuickDAQ Base** – This free-of-charge application allows you to perform the following functions:
  - Discover and select your devices.
  - Configure all input channel settings for the attached sensors.
  - Load/save multiple hardware configurations.
  - Generate output stimuli (fixed waveforms, swept sine waves, or noise signals).
  - On each supported data acquisition device, acquire data from all channels supported in the input channel list.
  - Choose to acquire data continuously or for a specified duration.
  - Choose software or triggered acquisition.
  - Log acquired data to disk in an .hpf file.
  - Display acquired data during acquisition in either a digital display using the Channel Display window or as a waveform in the Channel Plot window.
  - Choose linear or logarithmic scaling for the horizontal and vertical axes.
  - View statistics about the acquired data, including the minimum, maximum, delta, and mean values, and the standard deviation in the Statistics window.
  - Export time data to a .csv or .txt file; you can open the recorded data in Microsoft Excel® for further analysis.
  - Read a previously recorded .hpf data file.
  - Customize many aspects of the acquisition, display, and recording functions to suit your needs, including the acquisition duration, sampling frequency, trigger settings, filter type, and temperature units to use.
- **QuickDAQ FFT Analysis Option** – When enabled with a purchased license key, the FFT Analysis option includes all the features of the Base package plus these features:
  - The ability to switch between the Data Logger time-based interface and the FFT Analyzer block/average-based interface.
  - Supports software, freerun, or triggered acquisition with accept and reject controls for impact testing applications.
  - Allows you to perform single-channel FFT (Fast Fourier Transform) operations, including AutoSpectrum, Spectrum, and Power Spectral Density, on the acquired analog input data. You can configure a number of parameters for the FFT, including the FFT size, windowing type, averaging type, integration type, and so on.
  - Allows you to display frequency-domain data as amplitude or phase.
  - Supports dB or linear scaling with RMS (root mean squared), peak, and peak-to-peak scaling options
  - Supports linear or exponential averaging with RMS, vector, and peak hold averaging options.

- Supports windowed time channels.
- Supports the following response window types: Hanning, Hamming, Bartlett, Blackman, Blackman Harris, and Flat top.
- Supports the ability to lock the waveform output to the analysis frame time.
- Allows you to configure and view dynamic performance statistics, including the input below full-scale (IBF), total harmonic distortion (THD), spurious free dynamic range (SFDR), signal-to-noise and distortion ratio (SINAD), signal-to-noise ratio (SNR), and the effective number of bits (ENOB), for selected time-domain channels in the Statistics window.
- Supports digital IIR (infinite impulse response) filters.
- **QuickDAQ Advanced FFT Analysis Option** – When enabled with a purchased license key, this version includes all the features of the Base package with the FFT Analysis option plus these features:
  - Allows you to designate a channel as a Reference or Response channel.
  - Allows you to perform two-channel FFT analysis functions, including Frequency Response Functions (Inertance, Mobility, Compliance, Apparent Mass, Impedance, Dynamic Stiffness, or custom FRF) with H1, H2, or H3 estimator types, Cross-Spectrum, Cross Power Spectral Density, Coherence, and Coherent Output Power.
  - Supports the Exponential response window type.
  - Supports the following reference window types: Hanning, Hamming, Bartlett, Blackman, Blackman Harris, FlatTop, Exponential, Force, and Cosine Taper windows.
  - Supports real, imaginary, and Nyquist display functions.
  - Allows you to save data in the .uff file format.

## Supported Devices

You can acquire and analyze data from a number of devices using QuickDAQ, including the following:

- All DT-Open Layers devices that support A/D streaming
- MEASURpoint instruments
- TEMPpoint instruments
- VOLTpoint instruments
- DT8824 and DT8824-HV instrument modules
- DT8837 instrument modules (analog input operations only)

Analog output operations are supported on devices that support D/A streaming. Single-value analog output operations are currently not supported.

## Modes of Operation

You can use QuickDAQ in one of two operation modes:

- Acquisition mode – Use this mode if you want to acquire data in the analog input stream and/or output an analog waveform. This mode requires use of at least one of the supported Data Translation devices; refer to [page 18](#) for a list of supported devices.
- File reader mode – Use this mode if you want to view a previously recorded data file. Note that you cannot acquire new data using the File reader mode.

## Licensing Requirements

QuickDAQ includes a 14-day trial version of the FFT Analysis and Advanced FFT Analysis options. Once you start the software, you have 14 consecutive calendar days in which to try the features of the application.

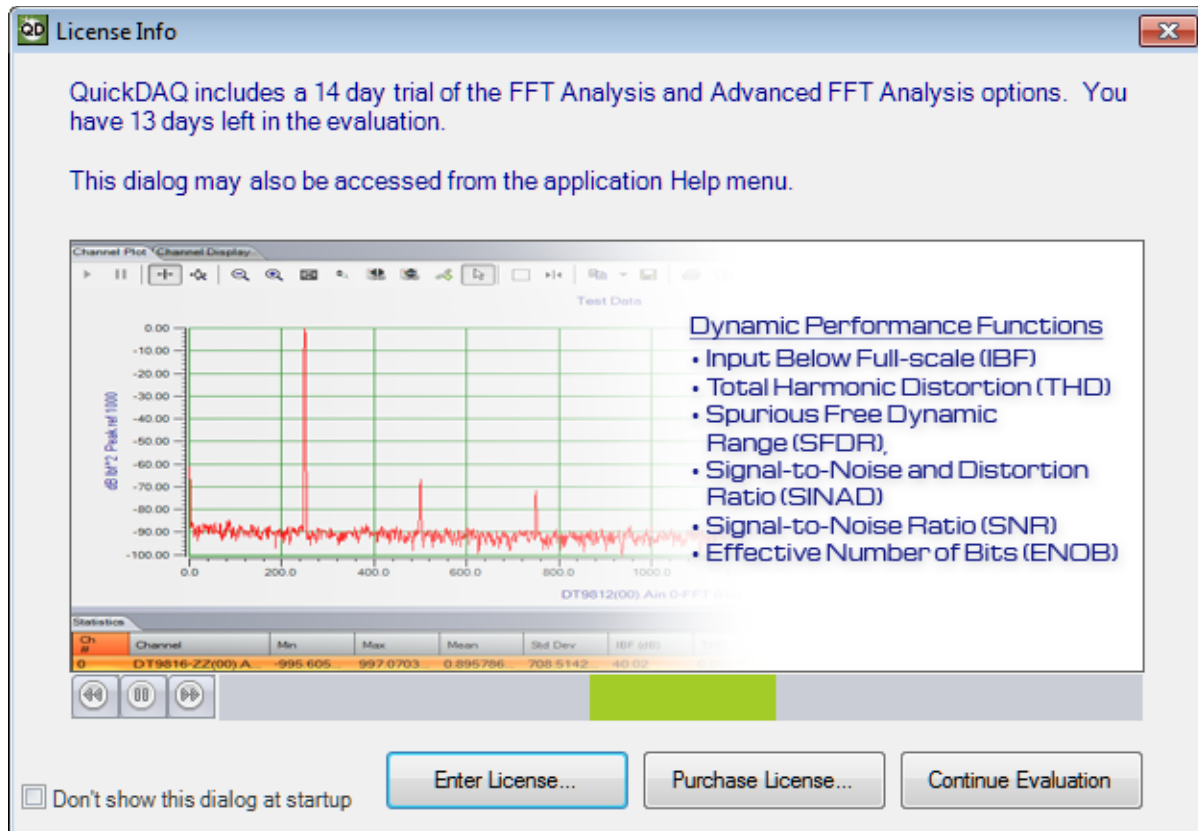

To use the trial version, click **Continue Evaluation**.

---

**Note:** If you do not want to show the License Info dialog, select the **Don't show this dialog at startup** checkbox. You can access the License Info dialog from the **License Information...** option of the **Help** menu.

---

When the 14-day trial period has elapsed, you can continue using the Base package, but the features of the FFT Analysis and Advanced FFT Analysis options are no longer available. The License Info dialog will no longer be shown.

If you want to continue using the analysis features, you must purchase either the FFT Analysis license key or the Advanced FFT Analysis license key depending on the features that you require. See [page 18](#) for the list of features that each option provides. To purchase a license, perform the following steps:

1. Click **Purchase License**.  
*The appropriate Data Translation web page is displayed.*
2. Purchase the license key for the analysis package that you want.
3. Click **Enter License** from the License Info dialog.  
*The Enter License Key dialog is displayed.*
4. If desired, you can copy the license key to the clipboard.
5. Enter the license key or paste the license key from the clipboard using the **Paste from Clipboard** button, and click **Apply License and Continue**.  
*If the application was running when you entered the license key, the application will restart. Otherwise, the application continues with either the Device Selection dialog, if an existing configuration file is not found, or the main interface.*

---

**Note:** If, after the trial period has expired, you try to load a configuration file that was saved with the FFT Analysis or Advanced FFT Analysis option, the configuration will not load and an error message will be generated.

If you have a license file for the FFT Analysis option but try to load a configuration file that was saved with the Advanced FFT Analysis option, the configuration will load but any FRF channels or other non-supported parameters will be missing.

---

## ***Resolution Requirements***

A minimum vertical screen resolution of 768 is required for proper operation of QuickDAQ.

In addition, it is recommended that you set the default font size to 100%. To do this, select **Control Panel, Display**, and then choose **Smaller (100%)**.







## ***Quick Start***

Installing the Software .....	26
Getting Started .....	27

## ***Installing the Software***

The QuickDAQ software is installed automatically when you install the device driver for your hardware.

No other software installation is required.

## Getting Started

To get started with QuickDAQ, follow these steps:

1. Connect a supported device to the network (Ethernet/LXI devices) or to the USB port of your computer (for USB devices), and connect your sensors to the device.
2. Start QuickDAQ.  
*The Device Selection window appears.*

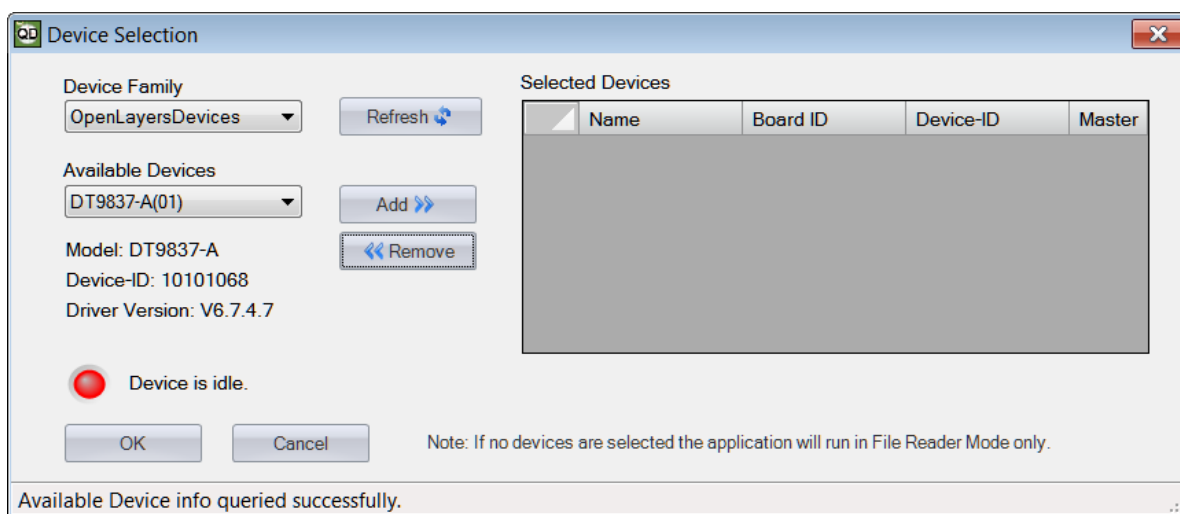

---

**Note:** If you ran QuickDAQ before and the devices that were used are still present and are not acquiring data, the Device Selection window is bypassed. If the devices support password protection, you must supply the correct password before the application launches. Refer to the user's manual for your device to determine the default password.

For devices that do not support password protection and that are currently acquiring data, a warning dialog box appears notifying you that another application is using the device. You cannot continue with QuickDAQ until the device is not acquiring data.

For devices that support password protection and that are currently acquiring data, the software alerts you that the device is acquiring data and gives you the option to abort acquisition and continue, or to cancel.

---

3. By default, the application "discovers" all devices that are available for the specified device family and displays their IP address (for Ethernet devices) or module name (for USB devices) in the drop-down list. If you want to refresh this list to determine if other devices are available, click **Refresh**.

**Notes:** The Device Family dropdown shows only the interfaces that are installed on your system.

OpenLayersDevices is the Device Family name for all Open Layers modules.

MEASURpoint-USB is the Device Family name for the USB versions of MEASURpoint, TEMPpoint, and VOLTpoint instruments.

MEASURpoint-ENET is the Device Family name for all Ethernet versions of MEASURpoint, TEMPpoint, and VOLTpoint instruments.

DT8824 is the Device Family name for all DT8824 Series instrument modules.

DT8837 is the Device Family name for the DT8837 instrument module.

---

4. Select the IP address (for Ethernet devices) or module name (for USB devices) for the device that you want to use from the list of Available Devices, and click **Add**.  
*Information about the device, including the board name, device ID, and driver version is displayed.*
5. For Ethernet devices, if your supported device is not included in the list of available devices, but you want to manually connect to it, do the following:
  - a. Click **Advanced**.

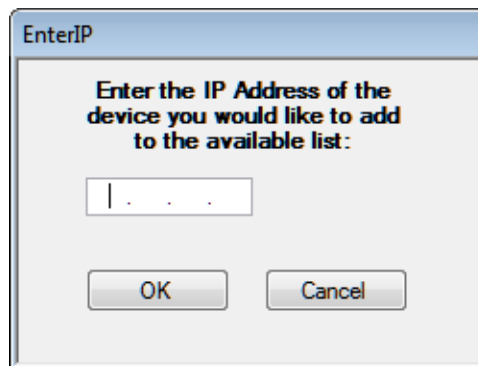

- b. Enter the IP address of the device that you want to connect to, and click **OK**.  
*Information about the device, including the board ID, device ID, firmware version, driver version, and scanning status is displayed.*
    - c. From the Device Selection window, click **Add**.

- d. If the device supports password protection, the Password Required dialog box appears:

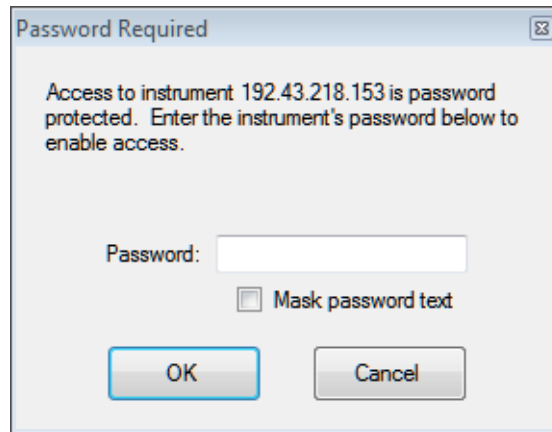

- e. If prompted, enter the password for the device. Refer to the user's manual for your device to determine the default password. By default, the **Mask password text** box is checked so that you cannot read the password as it is being typed. If desired, you can uncheck this box, if desired. (Note that the software does not allow you to continue if you do not enter the appropriate password for the device.)

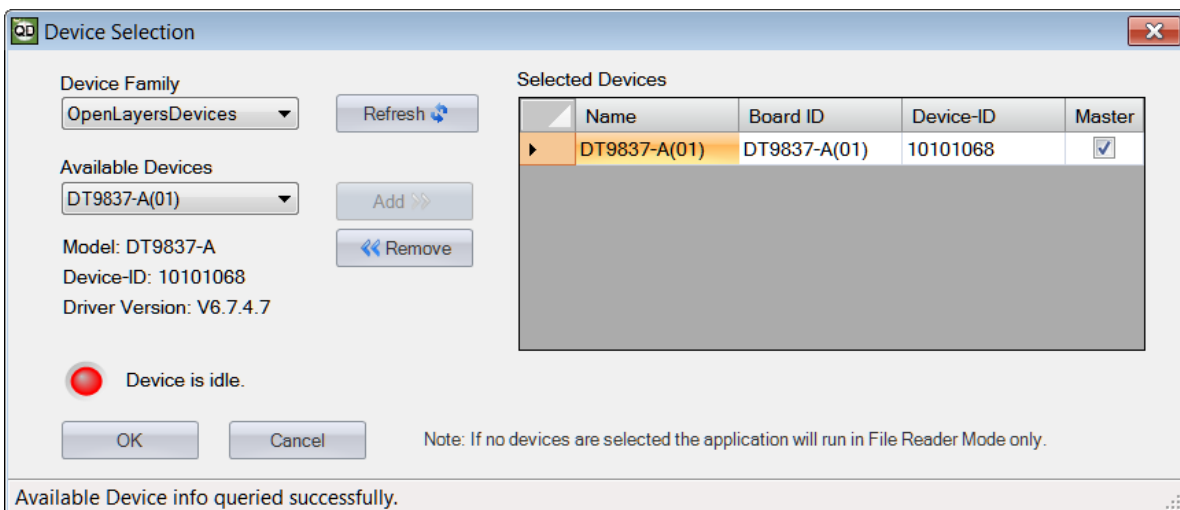

**Note:** If the device that you want to add does not support password protection and the device is currently acquiring data, a warning dialog box appears notifying you that another application is using the device. You cannot continue with QuickDAQ until the device is not acquiring data.

If the device that you want to add supports password protection and the device is currently acquiring data, the software alerts you that the device is acquiring data and gives you the option to abort acquisition and continue, or to cancel.

6. (Recommended) If you want to rename your device, do the following:
  - a. Click the Row Selector button for the device.
  - b. Click the IP address or module name in the **Name** column to highlight it and enter a meaningful name to represent each available device.

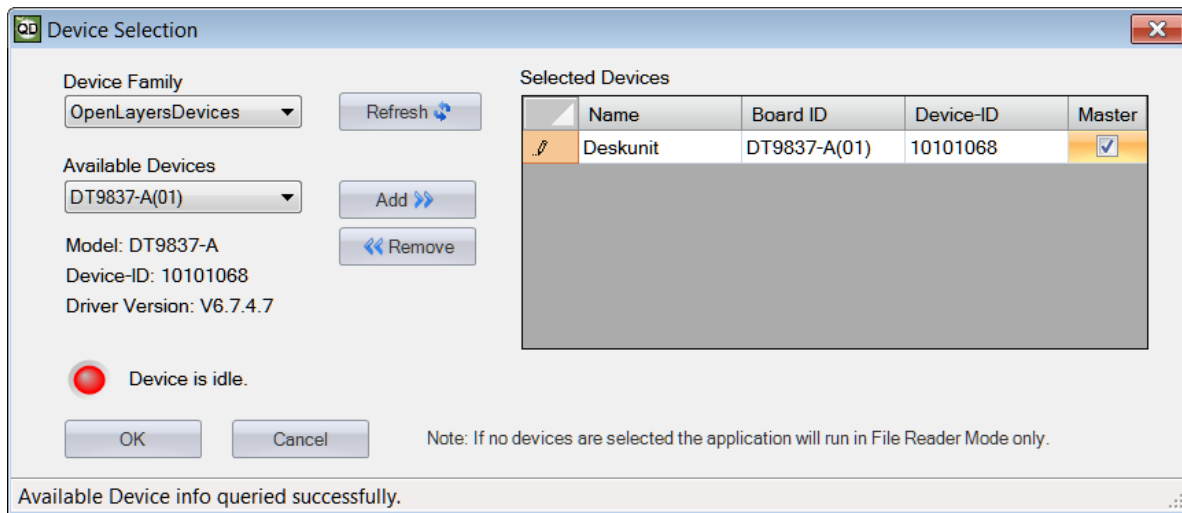

7. (Optional) If you want to remove a device from list of selected devices, click the Row Selector button for the device, and then click **Remove**.
8. Once you have added all the devices that you want to use with the application, click **OK**. *The latest state is saved and used when the application is next run, and the QuickDAQ interface is displayed.*

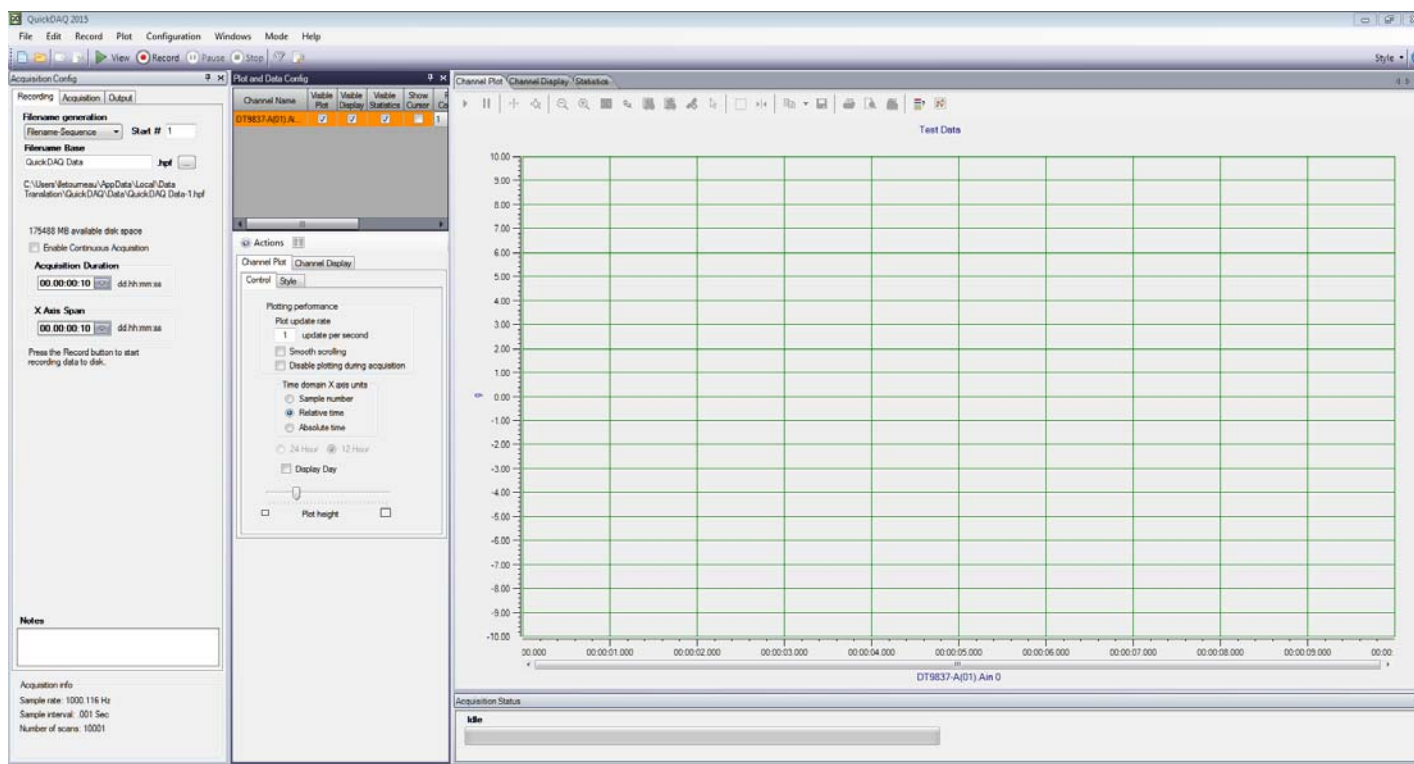

9. Configure the input channels of the device. (See [page 86](#).)
10. If you are using the FFT Analysis option or Advanced FFT Analysis option, choose either the Data Logger or FFT Analyzer interface mode. (See [page 48](#).)  
*The Base package provides the Data Logger interface mode only.*
11. If you are using the Data Logger interface mode, perform these steps:
  - a. Configure the recording settings of the device using the Recording tab of the Acquisition Config window. (See [page 121](#).)
  - b. Configure the frequency settings of the device using the Freq tab of the Acquisition Config window. (See [page 127](#).)
  - c. If you are using analog output channels, configure the parameters of the Output tab in the Acquisition Config window. (See [page 140](#).)
  - d. Set up the parameters of the Channel Plot, Channel Display, and/or Statistics windows. (See [Chapter 5](#) starting on [page 169](#).)
12. If you are using the FFT Analyzer interface mode, perform these steps:
  - a. Configure the recording settings of the device using the Recording tab of the Acquisition Config window. (See [page 124](#).)
  - b. Configure the frequency settings of the device using the Freq tab of the Acquisition Config window. (See [page 130](#).)
  - c. Configure the trigger parameters of the device using the Trigger tab of the Acquisition Config window. (See [page 133](#).)

- d. Configure the window functions for FFT channels using the Window tab of the Acquisition Config window. (See [page 137](#).)
  - e. If you are using analog output channels, configure the parameters of the Output tab of the Acquisition Config window. (See [page 140](#).)
  - f. If you are using digital filters, configure the digital filter settings. (See [page 164](#).)
  - g. Set up the parameters of the Channel Plot, Channel Display, and/or Statistics windows. (See [Chapter 6](#) starting on [page 191](#).)
13. To start acquisition without logging th data, click the **Record** menu and then click **View**, click the **View** toolbar button (  ), or hold down the **Alt** key and press the **F5** key.

*The results are displayed in the Channel Plot window and in the Channel Display window.*





## ***Understanding the Interface***

Overview of the Interface .....	34
Menus .....	36
Toolbar Buttons .....	50
Window Positioning .....	53
Acquisition Config Window .....	56
Plot and Data Config Window .....	65
Channel Plot Window .....	68
Channel Display Window .....	81
Statistics Window .....	82
Acquisition Status Window .....	84

# Overview of the Interface

The Base package of QuickDAQ provides a Data Logger interface, shown in [Figure 1](#).

If you using the FFT Analysis option or Advanced FFT Analysis option, you can choose either the Data Logger or FFT Analyzer interface using the **Mode** menu. [Figure 2](#) shows the FFT Analyzer interface of QuickDAQ.

Both interface modes include menus, toolbar buttons, a configuration area, which includes the Acquisition Config window and the Plot and Data Config window, a display area, which includes the Channel Display window, Channel Plot window, and Statistics window, and the Acquisition Status window.

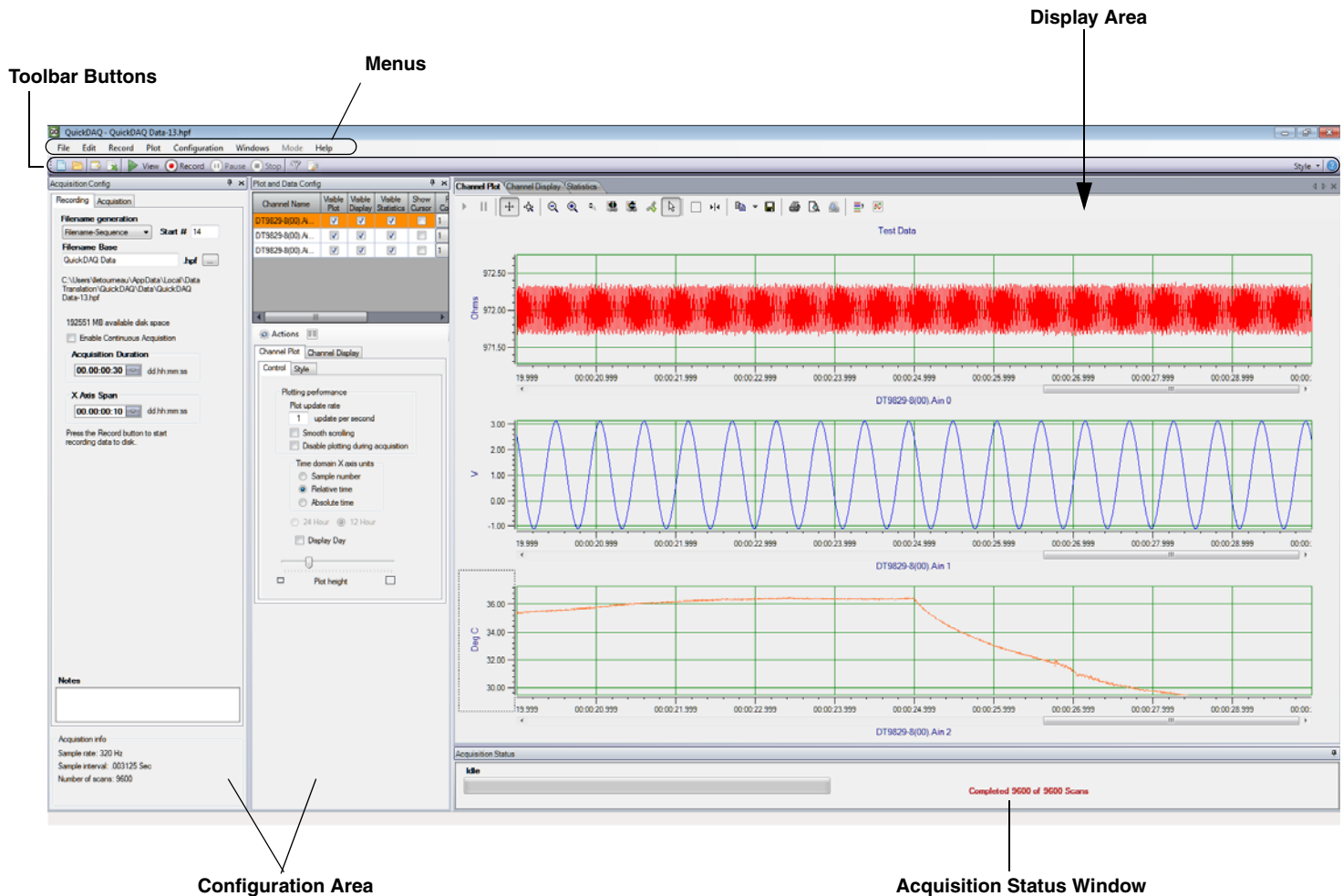

Figure 1: Data Logger Interface of QuickDAQ

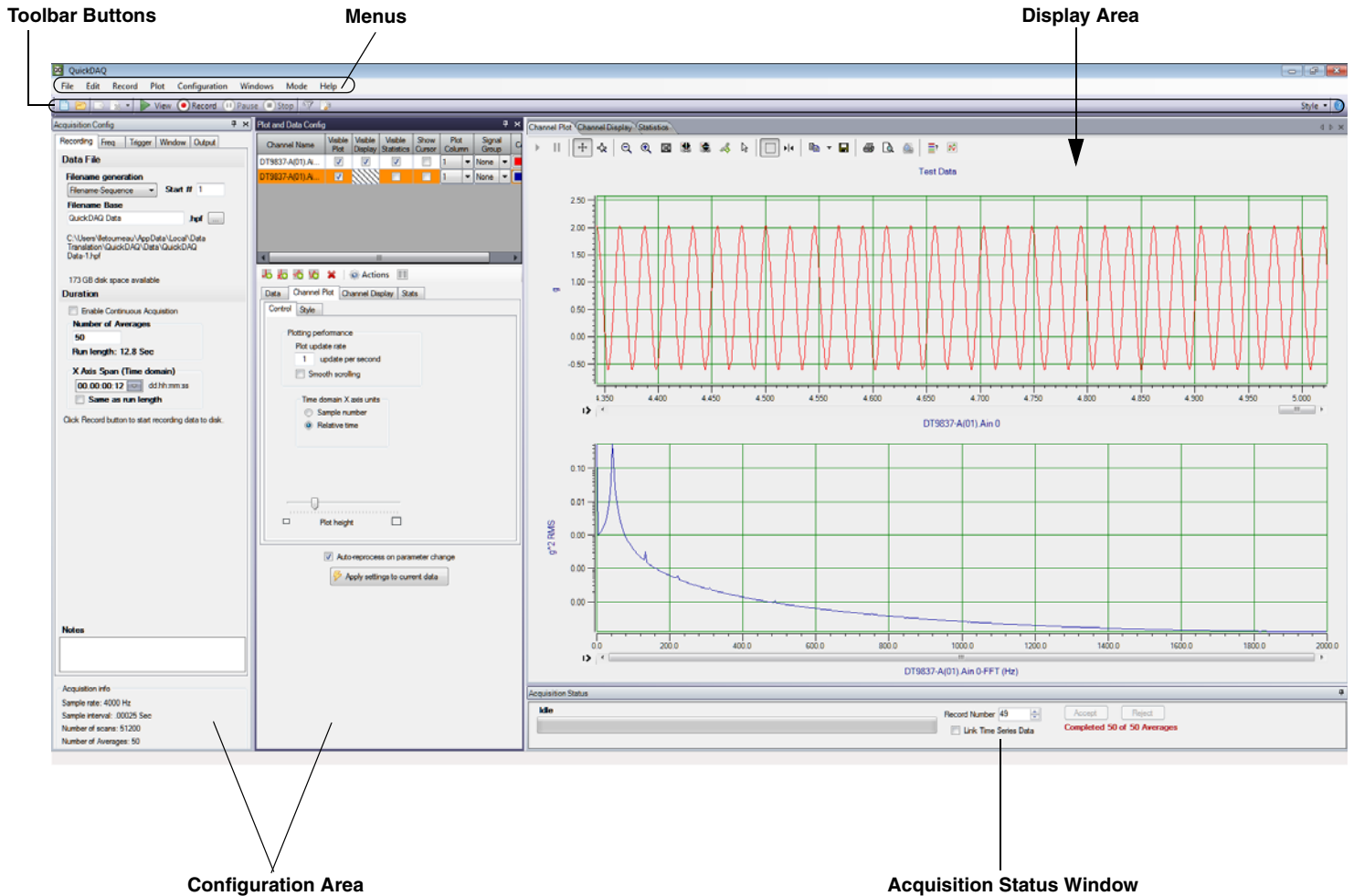

Figure 2: FFT Analyzer Interface of QuickDAQ

This chapter describes the features of both interface modes of QuickDAQ.

---

**Note:** You can customize the look of the interface, as desired. However, if you want to revert to the default layout, select **Windows** from the list of menus and select **Reset Window Layout to Default Layout**.

---

# Menus

QuickDAQ provides the following menus: **File**, **Edit**, **Record**, **Plot**, **Configuration**, **Windows**, **Mode**, and **Help**.

## File Menu

This section describes the options provided in the File menu.

### ***New Hpf Data File***

When you click the **New Hpf Data File** option of the File menu or click the **New HPF Data File** toolbar button , you can create a new (empty) data file for use with QuickDAQ. You can name and save the data file, as desired. The format of this file is High Performance binary (.hpf).

By default, the data file is stored in the following location:

*For Windows Vista, Windows 7, or Windows 8:*

C:\Users\\AppData\Local\Data Translation\QuickDAQ\Data

*For Windows XP:*

C:\Documents and Settings\\Local Settings\Application Data\  
Data Translation\QuickDAQ\Data

---

**Note:** To see the AppData folder, ensure that you set your view options to show hidden files. For example, in Windows 7, select **Control Panel** -> **Appearance and Personalization** -> **Folder Options**, select the **View** tab, and then select the **Show hidden files, folders, and drives** checkbox. Consult the documentation for your operating system for more information.

---

### ***Open Hpf Data File***

When you click the **Open Hpf Data File** option of the File menu or click the **Open HPF Data File** toolbar button , you can open an .hpf data file that was created using QuickDAQ.

A sample data file, called QuickDAQ Data.hpf, is provided, by default, in the following location:

*For Windows Vista, Windows 7, or Windows 8:*

C:\Users\\AppData\Local\Data Translation\QuickDAQ\Data

*For Windows XP:*

C:\Documents and Settings\\Local Settings\Application Data\  
Data Translation\QuickDAQ\Data

## Close Hpf Data File

The **Close Hpf Data File** option closes an opened data file (.hpf), restoring the previous state of QuickDAQ.

## Export Data

When you click the **Export Data** menu option from the File menu, or click the **Export Data** toolbar button , the File Export dialog appears. This dialog is different for each interface mode.

### File Export Dialog for the Data Logger Interface

The File Export dialog for the Data Logger interface is shown in [Figure 3](#).

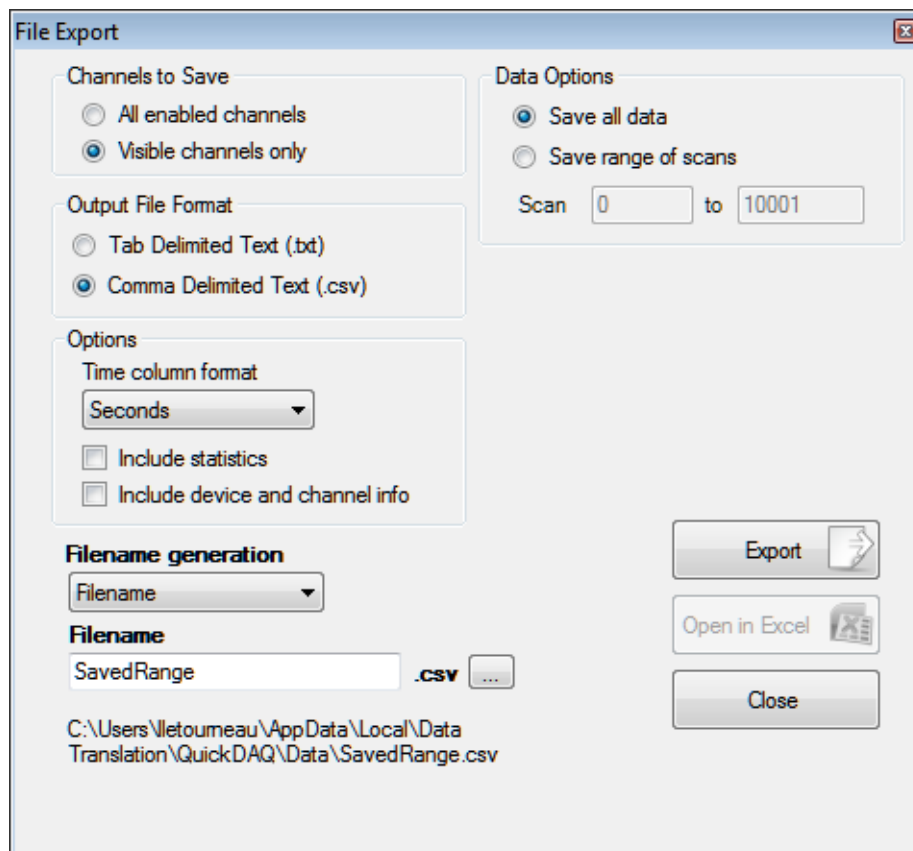

**Figure 3: File Export Dialog for the Data Logger Interface**

Configure this dialog as follows:

1. Under the **Channels to Save** area of the dialog, you can select whether to save the data from all channels or only those that are visible in the Channel Plot window or Channel Display window.

To save data from all channels, select **All channels**.

To save data from only the visible channels, select **Visible channels only**.

2. Under the **Data Options** area of the dialog, select which data to save.

You can save all scans by selecting **Save all data**, or save a subset of scans by selecting **Save range of scans** and entering the first scan and the last scan to save.

3. Under the **Output File Format** area of the dialog, select the file format to use when exporting the data:

- **Tab Delimited Text (.txt)** – This file format is used by a number of applications, including Microsoft Excel.
- **Comma Delimited Text (.csv)** – This file format is used by a number of applications, including Microsoft Excel.

---

**Note:** In tab delimited text (.txt) files, the time column shows the relative time in seconds of when the sample was acquired.

In comma delimited text (.csv) files, the time column shows the Excel time, where the number represents the number of days since 1900-Jan-0, plus a fractional portion of a 24 hour day. If you chose to display data as absolute time, then the first sample represents the start time of the acquisition. If you chose to display data in relative time, then the first sample represents time 0. Within Excel, you can format this column to use a more meaningful time option if you wish by right-clicking the selected column, choosing **Format Cells**, choosing **Time**, and selecting the option you want to use.

---

4. Under the **Time Column Format** area of the dialog, choose one of the following options for expressing the time corresponding to the data:

- Seconds
- milliSeconds
- microSeconds
- Time String
- Excel Time Format
- Sample Number

If you wish, you can export information about the statistics that correspond to the saved data, by selecting the **Include statistics** checkbox.

You can also export information about the device and channels that correspond to the saved data by selecting the **Include device and channel info** checkbox.

5. Under **Filename generation**, specify how to create the name of the file. You can choose one of the following options:
  - **Filename** – The specified filename is created when you click the **Export** button. Each time you click the **Export** button, you will be prompted to overwrite the file. SavedRange.uff is an example of a filename that was created using the **Filename** option.
  - **Filename-Sequence** – The specified filename is created and a starting number that you define is appended to the filename when you click the **Export** button. Each time you click the **Export** button, the number that is appended to the filename is incremented by one. SavedRange.txt-1 is an example of a filename that was created using the **Filename-Sequence** option.
  - **Filename-DateTime** – The specified filename is created and the current date and time is appended to the filename when you click the **Export** button. Each time you click the **Export** button, the filename with the current date and time is created. SavedRange-2012-06-25\_02-39-59-PM.txt is an example of a filename that was created using the **Filename-DateTime** option.
6. In the **Filename** text box, enter or browse to the name of the file that will contain the exported data.

*The path showing where the file is located is shown.*

The default location for saving the data files is as follows:

For Windows Vista, Windows 7, or Windows 8:  
C:\Users\\AppData\Local\Data Translation\QuickDAQ\Data

For Windows XP:  
C:\Documents and Settings\\Local Settings\Application Data\  
Data Translation\QuickDAQ\Data
7. Click the **Export** button to export the data to the file you specified.
8. Once the file is created, you can open the file in Microsoft Excel by clicking the **Open in Excel** button.
9. When you are finished exporting the data, close this dialog box by clicking the **Done** button.

## File Export Dialog for the FFT Analyzer Interface

The File Export dialog for the FFT Analyzer interface is shown in [Figure 4](#).

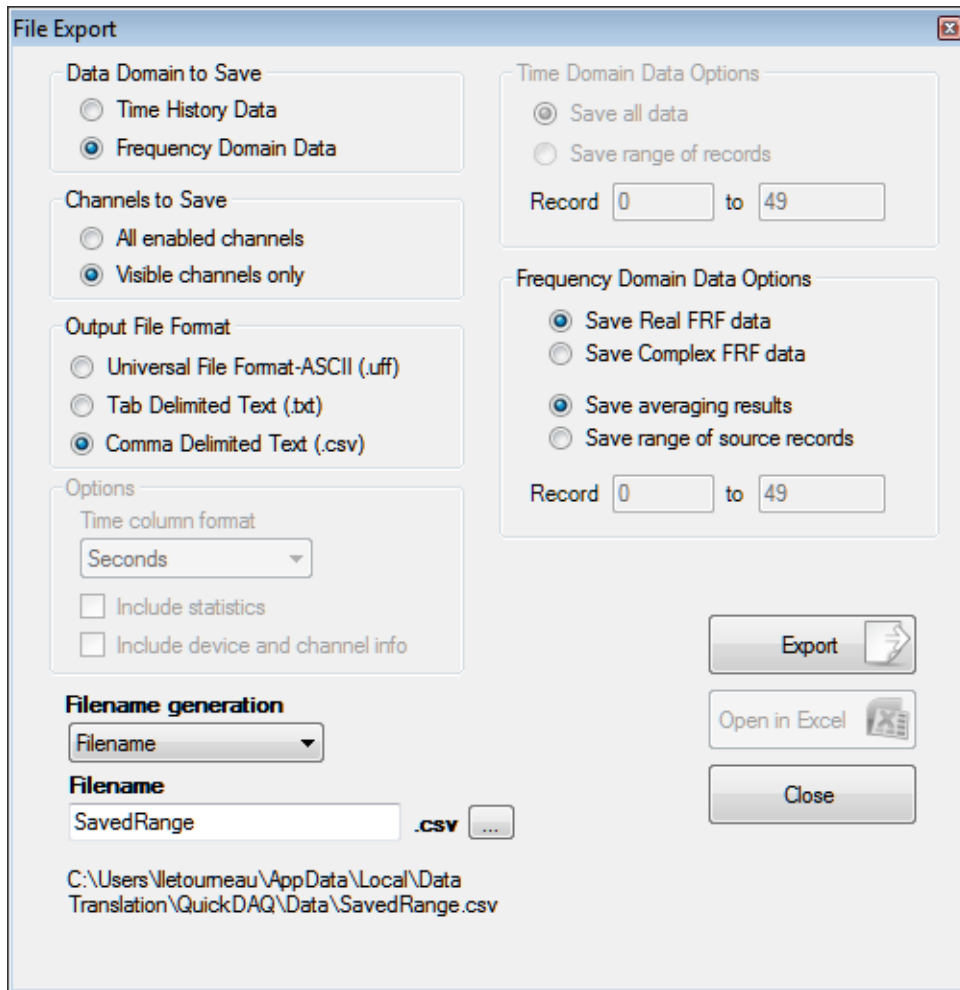

**Figure 4: File Export for the FFT Analyzer Interface**

Configure this dialog as follows:

1. Under the **Data Domain to Save** area of the dialog, choose the type of data to save.  
For time domain data, select **Time History Data**.  
For frequency domain data, select **Frequency Domain Data**.
2. If you selected **Time History Data**, select which records to save under the **Time Domain Data Options** area of the dialog.

You can save all the records by selecting **Save all data**, or save a subset of records by selecting **Save range of records** and entering the first record and the last record to save.



3. If you select **Frequency Domain Data**, you can select which data to save under the **Frequency Domain Data Options** area of the dialog.

You can save the average of all records by selecting **Save averaging results**, or save a subset of source records by selecting **Save range of source records** and entering the first record and the last record to save.

If you are using the Advanced FFT Analysis option and are using FRF channels, you also choose whether to save real data by selecting **Save Real FRF data** or complex data by selecting **Save Complex FRF data**.

4. Under the **Channels to Save** area of the dialog, you can select whether to save the data from all channels or only those that are visible in the Channel Plot window.

To save data from all channels, select **All channels**.

To save data from only the visible channels in the Channel Plot window, select **Visible channels only**.

5. Under the **Output File Format** area of the dialog, select the file format to use when exporting the data:

- **Universal File Format-ASCII (.uff)** – Available only in the Advanced FFT Analysis option of QuickDAQ, this file format is used by a number of applications, including ME'scope™ from Vibrant Technology.

- **Tab Delimited Text (.txt)** – This file format is used by a number of applications, including Microsoft Excel.

If this file format is selected, you can also choose to export information about the device and channels that correspond to the saved data, by selecting the **Include device and channel info** checkbox.

- **Comma Delimited Text (.csv)** – This file format is used by a number of applications, including Microsoft Excel.

If this file format is selected, you can also choose to export information about the device and channels that correspond to the saved data, by selecting the **Include device and channel info** checkbox.

---

**Note:** In tab delimited text (.txt) files, the time column shows the relative time in seconds of when the sample was acquired.

In comma delimited text (.csv) files, the time column shows the Excel time, where the number represents the number of days since 1900-Jan-0, plus a fractional portion of a 24 hour day. If you chose to display data as absolute time, then the first sample represents the start time of the acquisition. If you chose to display data in relative time, then the first sample represents time 0. Within Excel, you can format this column to use a more meaningful time option if you wish by right-clicking the selected column, choosing **Format Cells**, choosing **Time**, and selecting the option you want to use.

---

6. If you selected **Time History Data**, choose one of the following options under the **Time Column Format** area of the dialog for expressing the time corresponding to the data:
  - Seconds
  - milliSeconds
  - microSeconds
  - Time String
  - Excel Time Format
  - Sample Number

If you wish, you can export information about the statistics that correspond to the saved data, by selecting the **Include statistics** checkbox.

You can also export information about the device and channels that correspond to the saved data by selecting the **Include device and channel info** checkbox.

7. Under **Filename generation**, specify how to create the name of the file. You can choose one of the following options:
  - **Filename** – The specified filename is created when you click the **Export** button. Each time you click the **Export** button, you will be prompted to overwrite the file. SavedRange.uff is an example of a filename that was created using the **Filename** option.
  - **Filename-Sequence** – The specified filename is created and a starting number that you define is appended to the filename when you click the **Export** button. Each time you click the **Export** button, the number that is appended to the filename is incremented by one. SavedRange.uff-1 is an example of a filename that was created using the **Filename-Sequence** option.
  - **Filename-DateTime** – The specified filename is created and the current date and time is appended to the filename when you click the **Export** button. Each time you click the **Export** button, the filename with the current date and time is created. SavedRange-2012-06-25\_02-39-59-PM.uff is an example of a filename that was created using the **Filename-DateTime** option.

8. In the **Filename** text box, enter or browse to the name of the file that will contain the exported data.

*The path showing where the file is located is shown.*

The default location for saving the data files is as follows:

For Windows Vista, Windows 7, or Windows 8:

C:\Users\<<username>\AppData\Local\Data Translation\QuickDAQ\Data

For Windows XP:

C:\Documents and Settings\<<user name>\Local Settings\Application Data\  
Data Translation\QuickDAQ\Data

9. Click the **Export** button to export the data to the file you specified.
10. Once the file is created, you can open the file in Microsoft Excel by clicking the **Open in Excel** button.
11. When you are finished exporting the data, close this dialog box by clicking the **Done** button.

## Save Current Plot Image

The **Save Current Plot Image** option saves the current plot image from the Channel Plot window to a file.

To save the image to a file, specify the name of the file and choose one of the extensions to save the file as a graphic.

The default location for saving the current plot image files is as follows:

*For Windows Vista, Windows 7, or Windows 8:*

C:\Users\\AppData\Local\Data Translation\QuickDAQ\Data

*For Windows XP:*

C:\Documents and Settings\\Local Settings\Application Data\  
Data Translation\QuickDAQ\Data

## Open Current Data in Excel

The function of the **Open Current Data in Excel** menu option depends on the interface mode, described below.

---

**Note:** Before using this option, ensure that Microsoft Excel is installed on your computer. In addition, you must stop acquisition before trying to use this option, or the application cannot open the file.

---

### Open Current Data in Excel Using the Data Logger Interface

If you choose the **Open Current Data in Excel** menu option from the File menu or click the **Open Current Data in Excel** toolbar button , the application opens a tab-separated (tmp.tvts) file in Microsoft Excel that contains all the time domain data for the visible channels in the Channel Plot window.

You can then perform further analysis of your data using Excel or other utilities.

### Open Current Data in Excel Using the FFT Analyzer Interface

If you are using the FFT Analyzer Interface and choose the **Open Current Data in Excel** menu option from the File menu or click the **Open Current Data in Excel** toolbar button , you can specify either **Time History Data** or **Frequency Domain Data**.

If you select **Time History Data**, the application opens a tab-separated (tmp.tvts) file in Microsoft Excel that contains all the time domain data for the visible channels in the Channel Plot window.

If you select **Frequency Domain Data**, the application opens a tab-separated (tmp.tvts) file in Microsoft Excel that contains the average frequency domain data for the visible channels in the Channel Plot window.

You can then perform further analysis of your data using Excel or other utilities.

### **Load Configuration**

The **Load Configuration** option opens an .xml file of stored configuration settings.

### **Save Configuration**

The **Save Configuration** option saves the current application configuration to a user-specified filename with the .xml extension.

The default location for saving the configuration file is as follows:

*For Windows Vista, Windows 7, or Windows 8:*

C:\Users\<>username>\AppData\Local\Data Translation\QuickDAQ\Config.

*For Windows XP:*

C:\Documents and Settings\<>user name>\Local Settings\Application Data\  
Data Translation\QuickDAQ\Config

### **Open Hpf Data Folder**

The **Open Hpf Data Folder** option opens Windows Explorer in the current folder that is used to store .hpf data files. This provides a quick way to browse your data files.

The default location for saving the data files is as follows:

*For Windows Vista, Windows 7, or Windows 8:*

C:\Users\<>username>\AppData\Local\Data Translation\QuickDAQ\Data

*For Windows XP:*

C:\Documents and Settings\<>user name>\Local Settings\Application Data\  
Data Translation\QuickDAQ\Data

### **Open Export Data Folder**

The **Open Export Data Folder** option opens Windows Explorer in the current folder that is used to store exported data files. This provides a quick way to browse your exported files.

The default location for saving exported files is as follows:

*For Windows Vista, Windows 7, or Windows 8:*

C:\Users\<>username>\AppData\Local\Data Translation\QuickDAQ\Data

*For Windows XP:*

C:\Documents and Settings\<>user name>\Local Settings\Application Data\  
Data Translation\QuickDAQ\Data

## Page Setup

The **Page Setup** option allows you to configure the page before you print it. Options are available for configuring the size, orientation, and margins of the page.

## Print Preview

The **Print Preview** option allows you to preview the image from the Channel Plot window before you print it.

## Print

The **Print** option prints the picture from the Channel Plot window to a printer.

## Exit

The **Exit** option closes QuickDAQ, and saves the current device configuration in the QuickDAQConfiguration.xml file in the default configuration folder. You can also close the application by clicking the  button in the top, right-hand side of the application.

---

**Notes:** A backup configuration file (QuickDAQConfiguration.xml.bak) is saved in the default configuration folder when QuickDAQ is exited. If, when starting QuickDAQ, an error occurs and the configuration file cannot be restored, the backup file is used to restore the configuration.

If the device is acquiring data through another application, a warning dialog box appears notifying you that you cannot save the current configuration if you close the application.

---

## Exit without saving current configuration

The **Exit without saving current configuration** option closes QuickDAQ, but does not save the current device configuration.

## Edit Menu

The Edit menu has the following menu options:

- **Copy plot data to clipboard** – Copies the data from the Channel Plot window to the Windows clipboard.
- **Copy plot image to clipboard** – Copies the image from the Channel Plot window to the Windows clipboard.

## Record Menu

The Record menu has the following menu options:

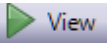
- **View** – Starts data acquisition on the device but does not log the data. This is equivalent to clicking the **View** button (  ) on the toolbar or holding down the **Alt** key and pressing the **F5** key. The View mode is useful when you want to verify your connections and settings, but are not ready to log data.

---

**Note:** After stopping the acquisition, you can use the scrollbar on the x-axis to scroll back through the data. However, since the data is not logged to disk, not all of the data may be available.

---

- **Record** – Starts data acquisition on the device and logs the data to a High Performance binary file (.hpf). This is equivalent to clicking the **Record** button (  ) on the toolbar or pressing the **F5** key. You can specify the name of the data file by opening a new Hpf file, described on [page 36](#), or by using the **Recording** tab, described on [page 121](#).



---

**Note:** You can use the scrollbar on the x-axis to pause tracking and scroll back through the data to the beginning of acquisition. Refer to [page 72](#) and [page 72](#) for more information on pausing and resuming tracking.

---



For long duration acquisitions, ensure that your computer's power options are set to never hibernate; refer to [page 386](#) for more information.

---

- **Pause** – Pauses recording. This is equivalent to clicking the **Pause** button (  ) on the toolbar or pressing the spacebar. To resume recording, click the **Pause** menu option, click the **Pause** button, or press the spacebar again.
- **Stop** – Stops the application from receiving data from the device. This is equivalent to clicking the **Stop** button (  ) on the main menu or holding down the **Shift** key and pressing the **F5** key. You must stop acquisition to make configuration changes.

## Plot Menu

The Plot menu has the following menu options:

- **Plot Area Mouse Mode** – You can select one of the following controls for the Channel Plot window:
  - **Select** – Allows you to select items in the view area to zoom or to scroll. This is equivalent to using the Select control (  ) of the Channel Plot window, or holding down the **Ctrl** and **Alt** keys while pressing the **V** key.
  - **Zoom** – Allows you to select a region in the view to magnify (zoom). This is equivalent to using the Zoom Box (  ) control of the Channel Plot window, or holding down the **Ctrl** and **Alt** keys while pressing the **Z** key.

Once in zoom mode, you can hold down the left mouse button, dragging the mouse to select the region that you want to magnify, and release the mouse button to magnify the area. The zoom action affects both axes.

- **Cursor** – Allows you to move the position of a data-cursor on the curve. This is equivalent to using the Data-Cursor (  ) control of the Channel Plot window, or holding down the **Ctrl** and **Alt** keys while pressing the **C** key.

Once in Data-Cursor mode, hold down the left mouse button and drag the mouse to move the data cursor. When the **Data-Cursor** is active, right-click the mouse to change the cursor style, line style, and/or color of the cursor; refer to [page 75](#) for more information.

- **Axis Mouse Mode** – You can select one of the following controls for the axis:

- **Scroll** – Allows you to scroll through the axes. This is equivalent to using the Axes Scroll (  ) control of the Channel Plot window.

Once in this mode, hold down the left mouse button and drag the mouse over the axis (up and down for the y-axis, or right and left for the x-axis) to scroll through the axes.

If you want to change the magnification (zoom) of the axes while this mode is selected, hold down the **Ctrl** button while holding down the left mouse button, and drag the mouse over the axis (up and down for the y-axis, or right and left for the x-axis).

- **Zoom** – Allows you to change the magnification (the zoom) of the axes. This is equivalent to using the Axes Zoom (  ) control of the Channel Plot window.

Once in this mode, you can change the magnification (the zoom) of the axes by holding down the left mouse button and dragging the mouse over the axis (up and down for the y-axis, or right and left for the x-axis).

## Configuration Menu

The Configuration menu has the following menu options:

- **Input Channel Configuration** – When you click this menu option or click the **Input Channel Configuration** toolbar button (  ), the **Configure Devices** dialog box appears. Using this dialog box, you can specify which input channels are sampled, and configure the sensor type, engineering units, number of millivolts per engineering unit, and the test point number for each channel.

Refer to [page 86](#) for more information about configuring channels.

- **Digital Filter Configuration** – This menu option is enabled only in the QuickDAQ FFT Analysis and Advanced FFT Analysis packages.

When you click this menu option or click the **Digital Filter Configuration** toolbar button (  ), the **Digital Filter Configuration** dialog box appears. Using this dialog box, you can specify the type of IIR (infinite impulse response) filter that you want to apply for each channel and the parameters for the each filter, including the filter category (low pass, high pass, band pass, band stop), filter order, cutoff frequencies, and dB ripple.

Refer to [page 164](#) for more information about configuring digital filters.

- **Device Selection** – Opens the Device Selection window, allowing you to select the devices for use with QuickDAQ in acquisition mode. Refer to [page 27](#) for more information about using the Device Selection window.

## Windows Menu

The Windows menu provides the following menu options:

- **Acquisition Config** window – Check this window option to show the Acquisition Config window. If this window option is unchecked, the Acquisition Config window is hidden. The Acquisition Config window allows you to configure the acquisition parameters of the data acquisition devices. Refer to [Chapter 4 starting on page 85](#) for more information on this window.
- **Plot and Data Config** window – Check this window option to show the Plot and Data Config window. If this window option is unchecked, the Plot and Data Config window is hidden. The Plot and Data Config window allows you to configure the appearance of the display. Refer to [Chapter 5 starting on page 169](#) for more information on this window.
- **Channel Plot** window – Check this window option to show the Channel Plot window. If this window option is unchecked, the Channel Plot window is hidden. This window allows you view the data from your device in a plot view. Refer to [page 68](#) and [page 171](#) for more information on this window.
- **Channel Display** window – Check this window option to show the Channel Display window. If this window option is unchecked, the Channel Display window is hidden. This window allows you view the data from your device in a digital display that resembles the front panel of the device. Refer to [page 81](#) and [page 171](#) for more information on this window.
- **Channel Statistics** window – Check this window option to show the Channel Statistics window. If this window option is unchecked, the Channel Statistics window is hidden. This window allows you view statistics about the data that you acquired. Refer to [page 82](#) for more information on this window.
- **Reset Window Layout to Last Saved** – Allows you to change the window layout to the last saved configuration.
- **Reset Window Layout to Default Layout** – Allows you to change the window layout to the default state.

## Mode Menu

The **Mode** menu is disabled (grayed out) if you are using the Base package of QuickDAQ.

If you using the FFT Analysis option or Advanced FFT Analysis option of QuickDAQ, the **Mode** menu provides the following options:

- **Data Logger** – This option selects the Data Logger interface. This is the interfaced provided in the Base package of QuickDAQ. Use this interface if you want to acquire data, display time-domain data, and log time-domain data to disk, and do not want to perform FFT analysis on the data using this application.
- **FFT Analyzer** – This option selects the FFT Analyzer interface. Use this interface if you want to acquire data, perform FFT analysis on the data, display the time-domain and/or frequency-domain data, and log the data to disk.



**Note:** If you are using the FFT Analysis option or Advanced FFT Analysis option of QuickDAQ, you can toggle between the two interfaces. The application remembers the configuration between toggles. However, when the application is closed, only the active interface mode is saved.

If you want the configuration of both interface modes to be saved, you must manually save the configuration for the interface that is not active before the application is closed.

---

## Help Menu

The Help menu provides the following options:

- **User Manual** – Opens this manual, which describes the functionality of QuickDAQ.
- **License Info** – Opens the License Info dialog, described in [page 21](#), which allows you to purchase and enter a license key for the FFT Analysis or Advanced FFT Analysis option of QuickDAQ.
- **About** – Provides version information about the QuickDAQ application.

You can also open this manual using the **Help** toolbar button (  ).

## Toolbar Buttons

The following buttons are provided on the toolbar:



- 
 – **New HPF Data File** – Creates a new (empty) data file for use with QuickDAQ. This is equivalent to using the **New Hpf Data file** menu option under the File menu, described on [page 36](#).

You can name and save the data file, as desired. The format of this file is High Performance binary (.hpf).

By default, the data file is stored in the following location:

*For Windows Vista, Windows 7, or Windows 8:*

C:\Users\<<username>\AppData\Local\Data Translation\QuickDAQ\Data

*For Windows XP:*

C:\Documents and Settings\<<user name>\Local Settings\Application Data\Data Translation\QuickDAQ\Data

- 
 – **Open HPF Data File** – Opens an .hpf data file that was created using QuickDAQ. This is equivalent to using the **Open Hpf Data file** menu option under the File menu, described on [page 36](#).



A sample data file, called QuickDAQ Data.hpf, is provided, by default, in the following location:

*For Windows Vista, Windows 7, or Windows 8:*

C:\Users\<<username>\AppData\Local\Data Translation\QuickDAQ\Data

*For Windows XP:*

C:\Documents and Settings\<<user name>\Local Settings\Application Data\Data Translation\QuickDAQ\Data

- 
 – **Export Data** – Opens the Export Data dialog box. This is equivalent to selecting the **Export Data** menu option of the File menu, described on [page 37](#).
- 
 – **Open Current Data in Excel** – After you stop recording, you can click this button to open a tab-separated (tmp.tvsv) file in Microsoft Excel that contains all the time domain data for the visible channels in the Channel Plot window.

You can then perform further analysis of your data using Excel or other utilities.

This is equivalent to selecting the **Open Current Data in Excel** menu option of the File menu, described on [page 43](#).

---

**Note:** Before using this option, ensure that Microsoft Excel is installed on your computer.

---

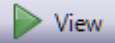
-  **View** – **View** – Starts data acquisition on the device but does not log the data. This is equivalent to selecting the **View** menu option of the Record menu or holding down the **Alt** key and pressing the **F5** key. The View mode is useful when you want to verify your connections and settings, but are not ready to log data.

---

**Note:** After stopping the acquisition, you can use the scrollbar on the x-axis to scroll back through the data. However, since the data is not logged to disk, not all of the data may be available.

---

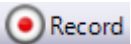

-  **Record** – **Record** – Starts data acquisition on the device and logs the data to a High Performance binary (.hpf) file. This is equivalent to selecting the **Record** menu option of the Record menu or pressing the **F5** key. You can specify the name of the data file using the **Recording** tab, described on [page 121](#).

---

**Note:** You can use the scrollbar on the x-axis to pause tracking and scroll back through the data to the beginning of acquisition. Refer to [page 72](#) and [page 72](#) for more information on pausing and resuming tracking.

For long duration acquisitions, ensure that your computer's power options are set to never hibernate; refer to [page 386](#) for more information.

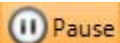
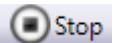
---



-  **Pause** – **Pause** – Pauses recording. This is equivalent to selecting the **Pause** menu option of the Record menu or pressing the spacebar. To resume recording, click the **Pause** button, click the **Pause** menu option, or press the spacebar again.
-  **Stop** – **Stop** – Stops acquisition. This is equivalent to the **Stop** menu option under the **Record** menu or holding down the **Shift** key and pressing the **F5** key. You must stop acquisition to make configuration changes.
-  – **Digital Filter Configuration** – Opens the Digital Filter Configuration dialog. This is equivalent to using the **Digital Filter Configuration** menu option of the Configuration menu, described on [page 47](#).

---

**Note:** This toolbar button is enabled only in the QuickDAQ FFT Analysis and Advanced FFT Analysis packages.

---

-  – **Input Channel Configuration** – Opens the Configure Devices dialog. This is equivalent to using the **Input Channel Configuration** menu option of the Configuration menu, described on [page 47](#).

-  **Style** – Allows you to configure the theme colors used by the application. You can select one of the following theme colors:
  - Office 2010 Blue
  - Office 2010 Silver
  - Office 2010 Black
  - Visual Studio 2010
  - Windows 7
  - Office 2007 Blue
  - Office 2007 Black
  - Office 2007 Silver
  - Vista Glass
  - Custom Scheme – Allows you to select your own color scheme to use for the application.
-  **Help** – Opens the this manual to describe QuickDAQ. This is equivalent to clicking the **User's Manual** menu option of the Help menu, described on [page 49](#).

## Window Positioning

The configuration area of the interface contains the Acquisition Config and the Plot and Data Config windows. The display area of the interface contains the Channel Plot, Channel Display, and Channel Statistics windows. The Acquisition Status window is located under the Channel Plot, Channel Display, and Statistics windows.

This section describes how to move, resize, dock, and hide windows in the interface. The remaining sections of this document describe each window in more detail.

### Moving, Resizing, and Docking Windows

---

**Note:** The Acquisition Status window is docked automatically. You cannot undock the Acquisition Status window.

---

You can move a window anywhere on the desktop by clicking the title bar or tab of the window and, while holding down the mouse button, dragging the window to the location you want. When you release the mouse button, this "floating" window remains in the location that you selected.

You can resize a window by clicking on any of the outside edges of the window and, while holding down the mouse button, dragging the window to the desired size. When you release the mouse, the window is scaled automatically.

You can also dock a window by doing the following:

1. Click the title bar or tab of the window.
2. Drag the window to where you want to dock it.  
*A guide diamond appears.*

*For windows in the configuration area, the four guides on the outside of the diamond represent the four sides of the configuration area. The center square docks the tabbed window in the configuration area. Additional guides are provided when you move the windows in the configuration area, allowing you to dock the window to the left side of the configuration area or to the right or left side of the display area.*

*For windows in the display area, the four guides on the outside of the diamond represent the four sides of the display area. The center square docks the tabbed window in the display area.*

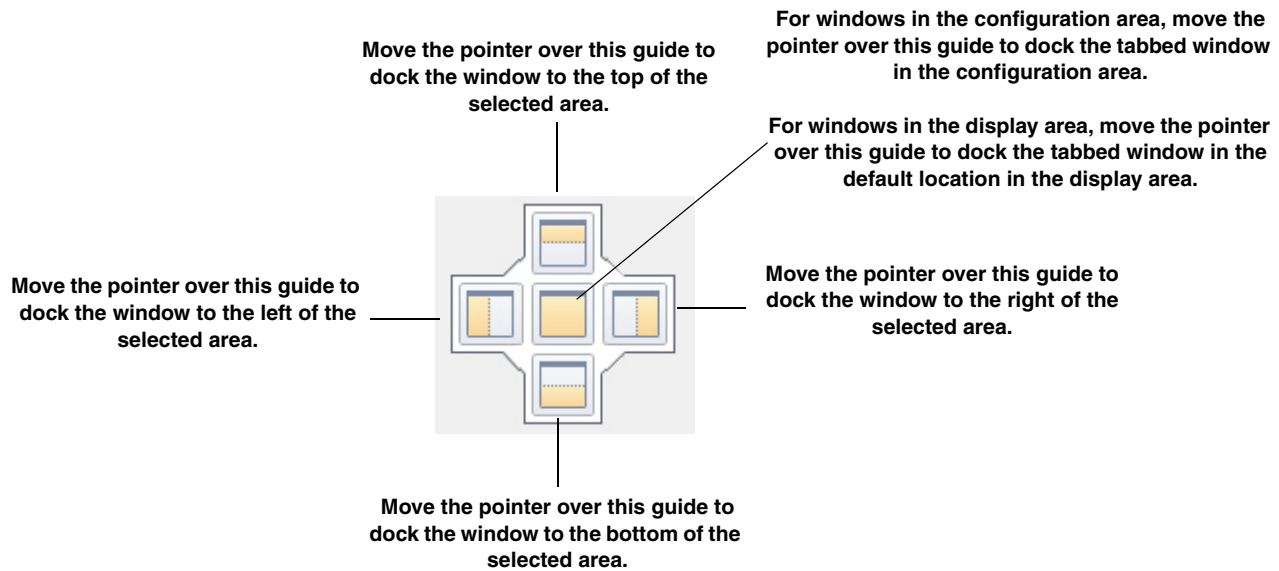

3. Move the pointer over the corresponding portion of the guide (the designated area is shaded), and release the mouse.

For example, if you want to dock the Acquisition Config window to the left side of the configuration area, drag the Acquisition Config window toward the middle of the configuration area, move the pointer over the guide on the far left, and then release the mouse button.

---

**Notes:** To return a window in the display area to its most recent docked location, press **CTRL** while you double-click the title bar of the window.

To dock/undock a window in the configuration area, press **CTRL** while you double-click the title bar of the window.

---

## Hiding a Window

For all windows, except the Acquisition Status window, you can hide the window by clicking the "X" at the top, right corner of the window. To show the window again, click the **Windows** menu, and check the name of the window to show. Any window name that is not checked under the **Windows** menu is hidden.

You can hide the Acquisition Status window and the windows in the configuration area, if desired, by clicking the **Auto-Hide** pin (  ) in the top, right corner of the window. When the window is hidden, a tab for the window is created; the size of the display area is increased. When the window is shown, the size of the display area is decreased. To see the window again, hover over the tab for the window. Click the **Auto-Hide** pin again to display the window.

## **Resetting the Window Layout**

If you want to reset the windows to their default view, select the **Windows** menu, and select **Reset Window Layout to Default Layout**.

You can also reset the display area to its last saved configuration by selecting the **Windows** menu, and selecting **Reset Window Layout to Last Saved**.

## Acquisition Config Window

The contents of the Acquisition Config window depend on the interface mode that is selected, as described below.

### Acquisition Config Window for the Data Logger Interface

When using the Data Logger interface, the Acquisition Config window provides the following tabs for configuring the acquisition and output settings used by the device. Based on the information you set, the current sample rate, sample interval, and number of scans used by the device are displayed.

- **Recording tab** – This tab allows you to set up the file name for the data file, enable or disable continuous acquisition, and to specify the acquisition duration and x-axis span.

Refer to [page 121](#) for more information about using this tab to configure the recording settings.

The screenshot shows the 'Recording' tab of the Acquisition Config window. It features two tabs: 'Recording' (selected) and 'Acquisition'. The 'Recording' tab contains the following settings:

- Filename generation:** A dropdown menu set to 'Filename-Sequence' and a 'Start #' field set to '1'.
- Filename base:** A text field containing 'QuickDAQ Data', a file type dropdown set to '.hpf', and a browse button (...).
- File path:** A text field showing the full path: 'C:\Users\Nletoumeau\AppData\Local\Data Translation\QuickDAQ\Data\QuickDAQ Data-1.hpf'.
- Disk space:** A label indicating '199438 MB available disk space'.
- Enable Continuous Acquisition:** An unchecked checkbox.
- Acquisition Duration:** A dropdown menu set to '00.00:00:10' and a label 'dd.hh:mm:ss'.
- X Axis Span:** A dropdown menu set to '00.00:00:10' and a label 'dd.hh:mm:ss'.
- Instructions:** A text prompt: 'Press the Record button to start recording data to disk.'
- Notes:** A large empty text area for user notes.



- **Acquisition tab** – This tab allows you to set up the parameters that apply to the analog input subsystem, including the per channel sampling frequency of the device, the trigger source that starts the acquisition, the channel configuration (single-ended or differential), input voltage range, the temperature units to use when converting voltage data to temperature, and/or the filter type. Refer to [page 123](#) for more information about using this tab to configure the acquisition settings.

The screenshot displays the 'Acquisition' tab of a software interface. It features three sub-tabs: 'Recording', 'Acquisition', and 'Output'. The 'Acquisition' tab is active and contains the following settings:

- Per Channel Sampling Frequency:** A text input field contains '195.313' followed by 'Hz'. Below it, the range '(195.3Hz -105469Hz)' is displayed.
- Trigger Source:** A dropdown menu is set to 'Analog Threshold Pos Edge'.
- Threshold Trigger Options:** A sub-panel containing:
  - Threshold value :** A text input field contains '2.5' followed by 'V' and '(2.5V)'. Below it, the range '(-10 - 10 V)' is displayed.
  - Channel:** A dropdown menu is set to 'DT9837-C(00).Ain 0'.
- Single Ended/Differential:** A dropdown menu is set to 'SingleEnded'.
- Input Voltage Range:** A dropdown menu is set to '-10V to 10V'.

- **Output tab** – This tab appears if your device supports continuous analog output operations. It allows you to set up the parameters for an analog output signal. You can define the type of waveform to output (fixed, sweep, or noise), and all the parameters that apply to that waveform type, including the signal or noise type, sweep mode, whether the signal is output continuously or as a burst, the frequency of the output signal, whether to ramp up or down, and how to start the operation. Refer to [page 140](#) for more information about using this tab to configure the output settings.

The screenshot shows the 'Output' tab of a software interface. At the top, there are three tabs: 'Recording', 'Acquisition', and 'Output'. Below the tabs is a table with the following columns: 'Enable', 'Channel Name', 'Waveform', 'Peak Voltage', and 'Offset'. The 'Enable' checkbox is checked. The 'Channel Name' is 'DT9837-C(00...'. The 'Waveform' is set to 'Fixed'. The 'Peak Voltage' is '1' and the 'Offset' is '0'.

Below the table is the 'Waveform' section, which includes:

- Signal Type:** A dropdown menu set to 'Sine'.
- Frequency:** A text input field with '100.00' and a unit dropdown set to 'Hz'.
- Output Mode:** A dropdown menu set to 'Burst'.
- Repeat burst

Below the 'Waveform' section is the 'Options' section, which includes:

- Burst On Time:** A text input field with '1.0000' and a unit dropdown set to 'Sec'.
- Burst Off Time:** A text input field with '0.00000' and a unit dropdown set to 'Sec'.
- Lock to acquisition time
- Ramp Up Time:** A text input field with '0.00000' and a unit dropdown set to 'Sec'.
- Ramp Down Time:** A text input field with '0.00000' and a unit dropdown set to 'Sec'.

At the bottom of the interface is the 'Start/Stop Method' section, which includes:

- Start/Stop Method:** A dropdown menu set to 'With Acquisition'.
- A speaker icon and a 'Start' button.
- Trigger Source:** A dropdown menu set to 'Software'.

## Acquisition Config Window for the FFT Analyzer Interface

If you are using the FFT Analyzer interface, the Acquisition Config window provides the following tabs for configuring the acquisition and output settings used by the device:

- **Recording tab** – This tab allows you to set up the data file name, enable or disable continuous acquisition, specify how many records to acquire, process, and average, and enter notes about the acquisition.

A *record* is a block of data whose length is equal to the size of the FFT. An *average* is a series of measurements that are combined to create a result. The results from the last completed measurement are combined, point by point, with the results from the previous measurement. The combined results are retained and displayed as they are updated.

Refer to [page 124](#) for more information about using this tab to configure the recording settings.

Recording Freq Trigger Window Output

### Data File

**Filename generation**  
Filename-Sequence Start # 1

**Filename Base**  
QuickDAQ Data .hpf ...

C:\Users\letoumeau\AppData\Local\Data Translation\QuickDAQ\Data\QuickDAQ Data-2.hpf

173 GB disk space available

### Duration

Enable Continuous Acquisition

**Number of Averages**  
50  
Run length: 12.8 Sec

**X Axis Span (Time domain)**  
00.00:00:12 dd.hh:mm:ss  
 Same as run length

Click Record button to start recording data to disk.

### Notes

**Acquisition info**  
Sample rate: 4000 Hz  
Sample interval: .00025 Sec  
Number of scans: 51200  
Number of Averages: 50

- **Freq tab** – This tab allows you to set up the maximum frequency that you are interested in analyzing, the FFT size, and other parameters that apply to the analog input subsystem, including the channel configuration (single-ended or differential), input voltage range, the temperature units to use when converting voltage data to temperature, and/or the filter type. Refer to [page 130](#) for more information about using this tab to configure the frequency settings.

The screenshot shows a software interface with four tabs: Recording, Freq, Trigger, and Window. The Freq tab is active, displaying the 'Analysis Frequency' settings. The settings are as follows:

- Maximum frequency to analyze:** 5
- FFT Size:** 1024
- Number of spectral lines:** 512
- Frequency resolution:** 0.01 Hz
- Single Ended/Differential:** Differential
- Input Voltage Range:** -10V to 10V
- Temperature Unit:** Celsius
- Filter Type:** Moving Average

- **Trigger tab** – This tab allows you to specify the trigger source that starts acquisition on the device, and the trigger mode. Refer to [page 133](#) for more information about using this tab to configure the triggers settings.

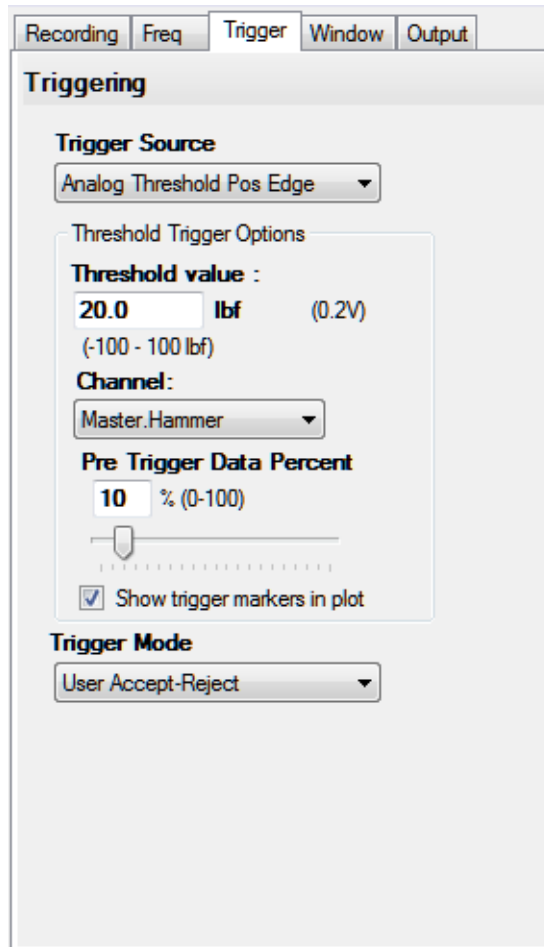

- **Window tab** – This tab allows you to specify a windowing function to apply to the FFT channel to reduce spectral leakage errors. If you are using the FFT Analysis option, the Window tab appears as shown in Figure 5. If you are using the Advanced FFT Analysis option, the Window tab appears as shown in Figure 6.

Refer to [page 137](#) for more information about using this tab to configure a windowing function.

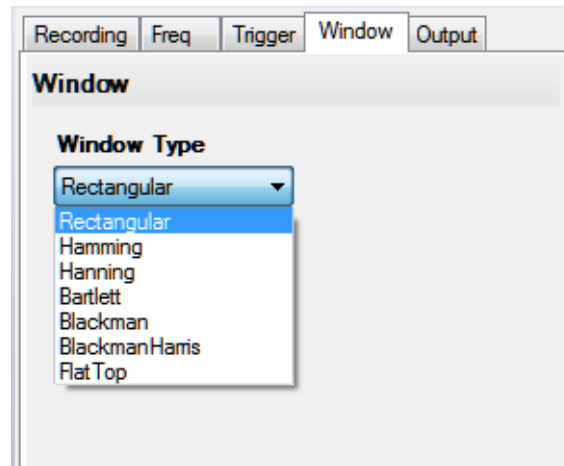

Figure 5: Window Tab for the FFT Analysis Option

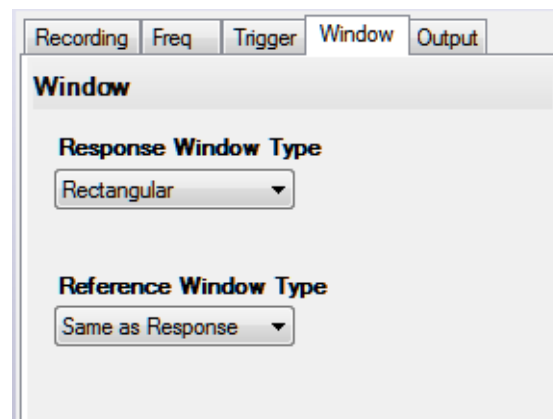

Figure 6: Window Tab for the Advanced FFT Analysis Option

- **Output tab** – This tab allows you to set up the parameters for an analog output signal, if your device supports analog output operations. You can define the type of waveform to output (fixed, sweep, or noise), and all the parameters that apply to that waveform type, including the signal or noise type, sweep mode, whether the signal is output continuously or as a burst, the frequency of the output signal, whether to ramp up or down, and how to start the operation.

Refer to [page 140](#) for more information about using this tab to configure the output settings.

Recording	Freq	Trigger	Window	Output
Enable	Channel Name	Waveform	Peak Voltage	Offset
<input checked="" type="checkbox"/>	DT9839(00)-...	Fixed	1	0

### Waveform

<b>Signal Type</b>	<b>Frequency</b>
Sine	100.07 Hz

**Output Mode**

Burst

Repeat burst

### Options

<b>Burst On Time</b>	<b>Burst Off Time</b>
0.9993 Sec	0.0006447 Sec

Lock to acquisition time  
 Lock to analysis frame time

<b>Ramp Up Time</b>	<b>Ramp Down Time</b>
0.00000 Sec	0.00000 Sec

### Start/Stop Method

With Acquisition

### Trigger Source

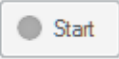
Software



## Plot and Data Config Window

The contents of the Plot and Data Config window depend on the interface mode that is selected, as described below.

### Plot and Data Config Window for the Data Logger Interface

When you are using the Data Logger interface, the Plot and Data Config window allows you to select which channels you want to plot and specify the appearance of the display area.

Refer to [Chapter 5](#) for information about how to configure the settings of the Plot and Data Config window.

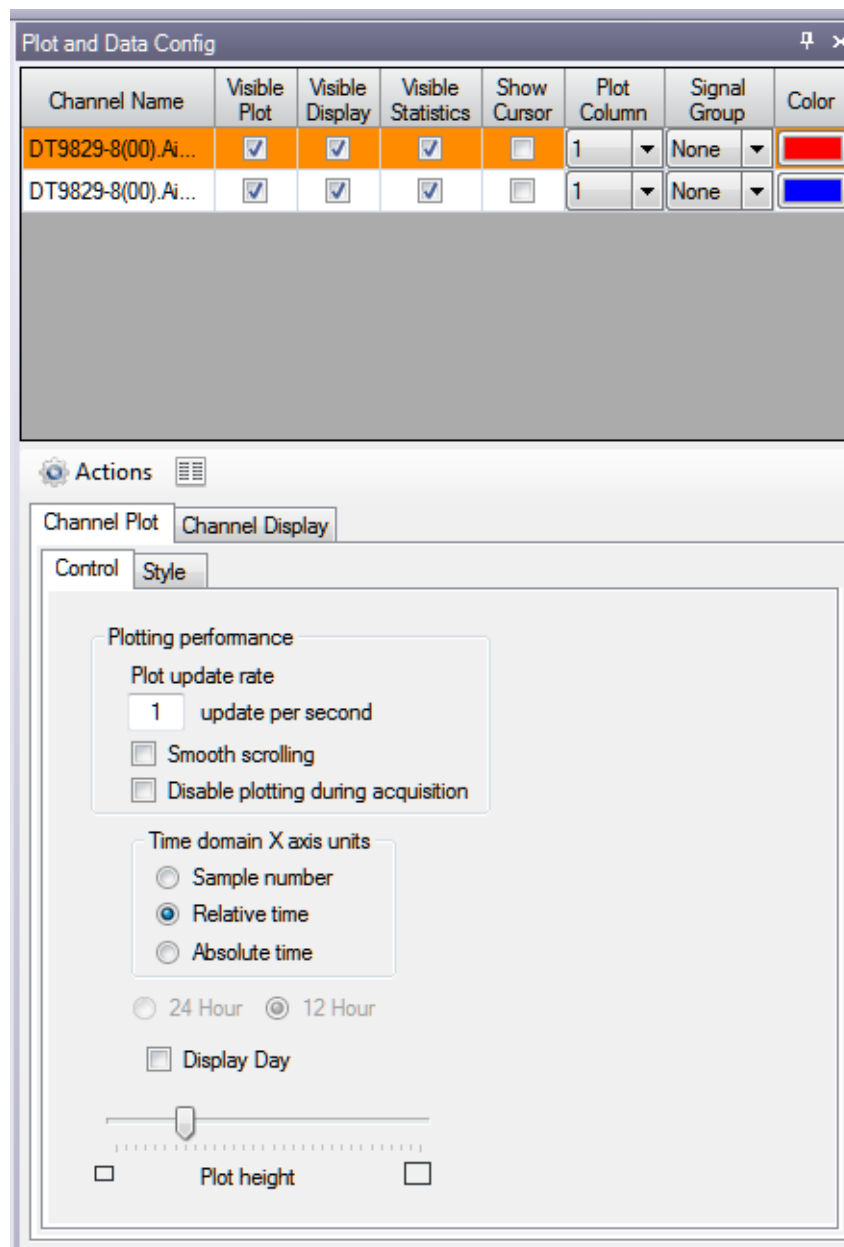

## Plot and Data Config Window for the FFT Analyzer Interface

When you are using the FFT Analyzer interface, the Plot and Data Config window allows you to select which channels you want to plot, add and remove single FFT functions, add and remove two-channel FFT functions (if you purchased the Advanced FFT Analysis option of QuickDAQ), specify the type of data analysis operations to perform on the selected channels, and specify the appearance of the display area. [Figure 7](#) shows the Plot and Data Config window for the FFT Analysis option.

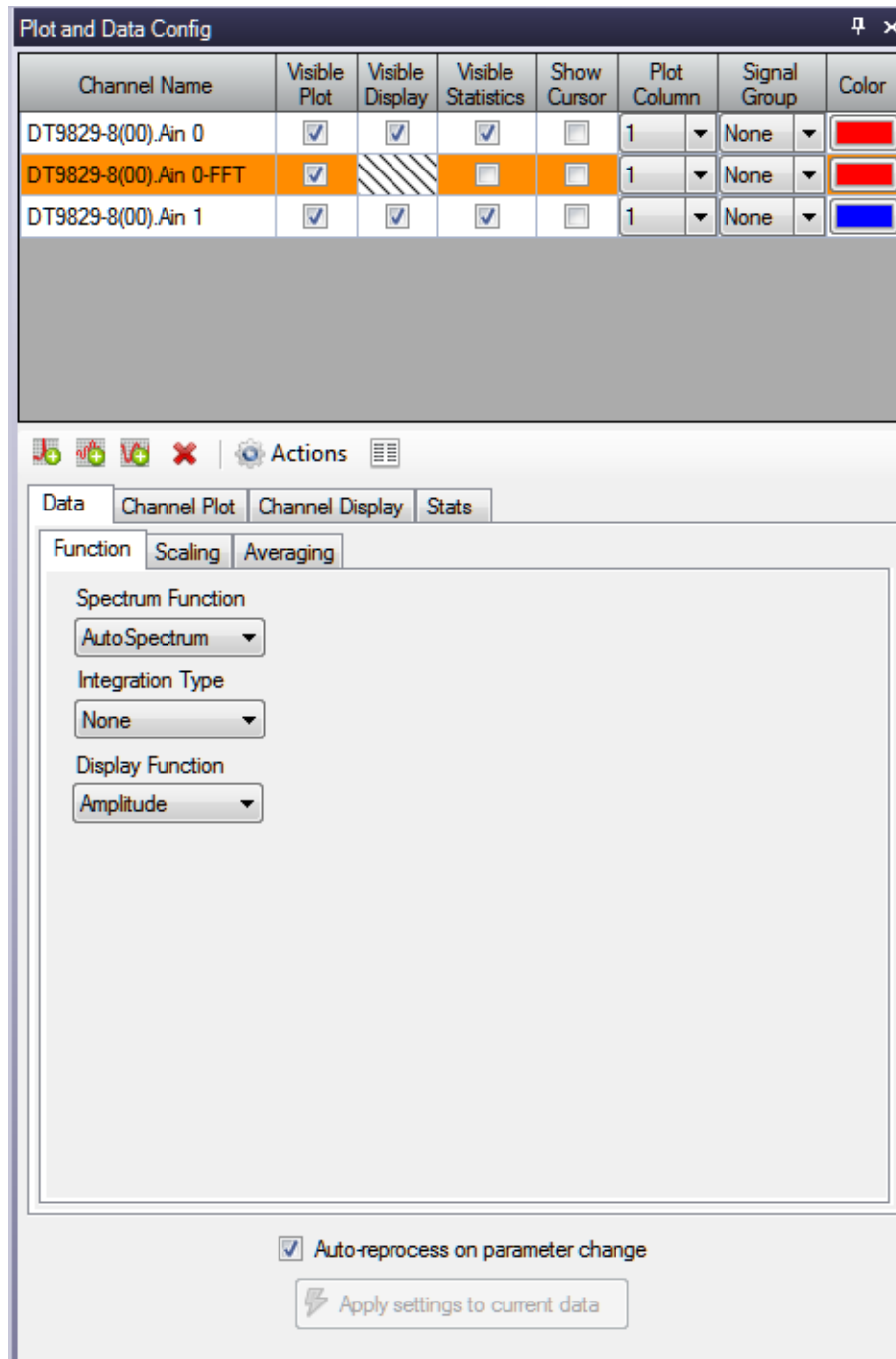

Figure 7: Plot and Data Config Window for the FFT Analysis Option

Figure 7 shows the Plot and Data Config window for the Advanced FFT Analysis option.

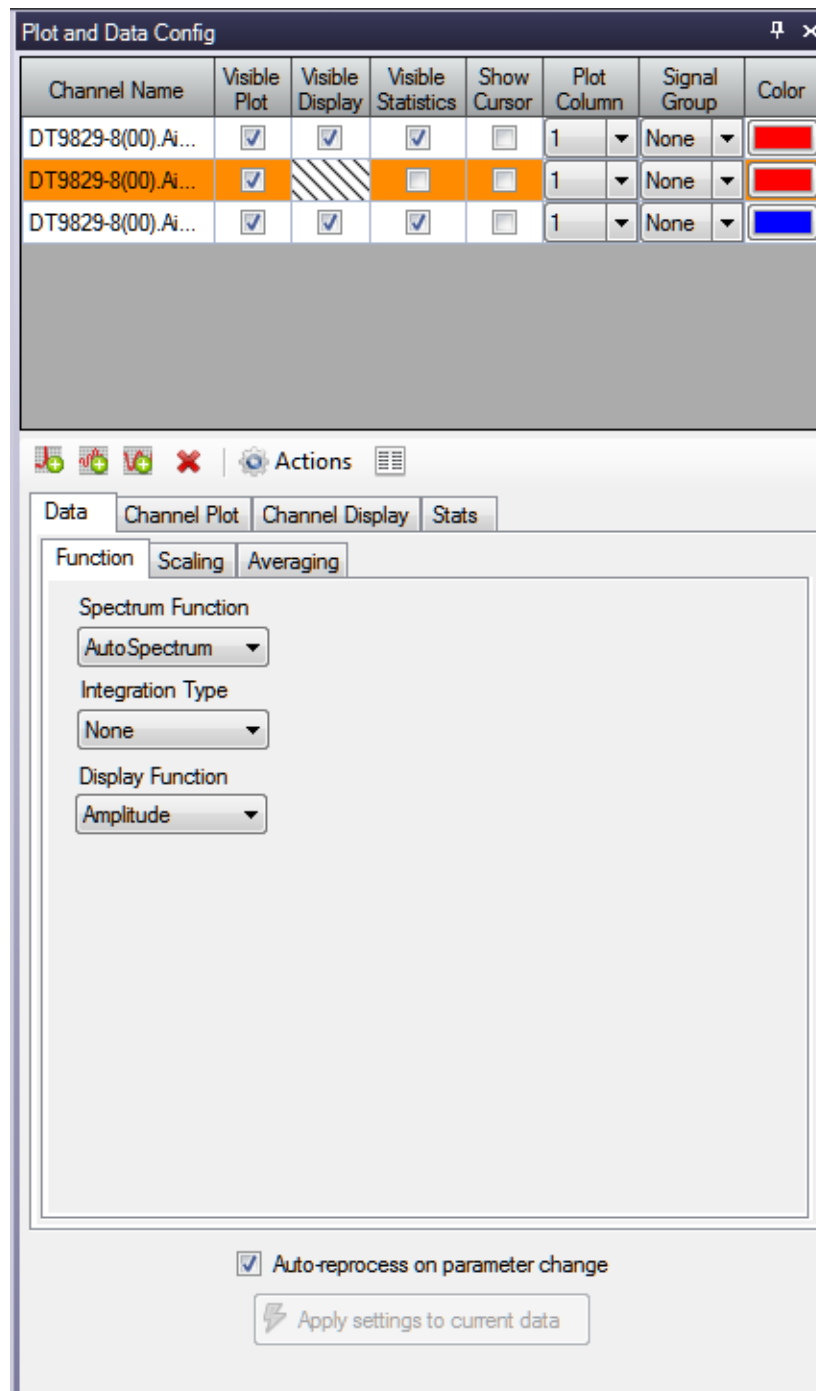

Figure 8: Plot and Data Config Window for the Advanced FFT Analysis Option

Refer to [Chapter 6](#) for information about how to configure the settings of the Plot and Data Config window.

## Channel Plot Window

You can access the Channel Plot window by clicking the **Channel Plot** tab in the display area of the interface or by clicking the **Channel Plot** menu option under the **Windows** menu.

During acquisition, the results are plotted in the Channel Plot window in real time. In file-reader mode, the results are read from the file and plotted in the Channel Plot window.

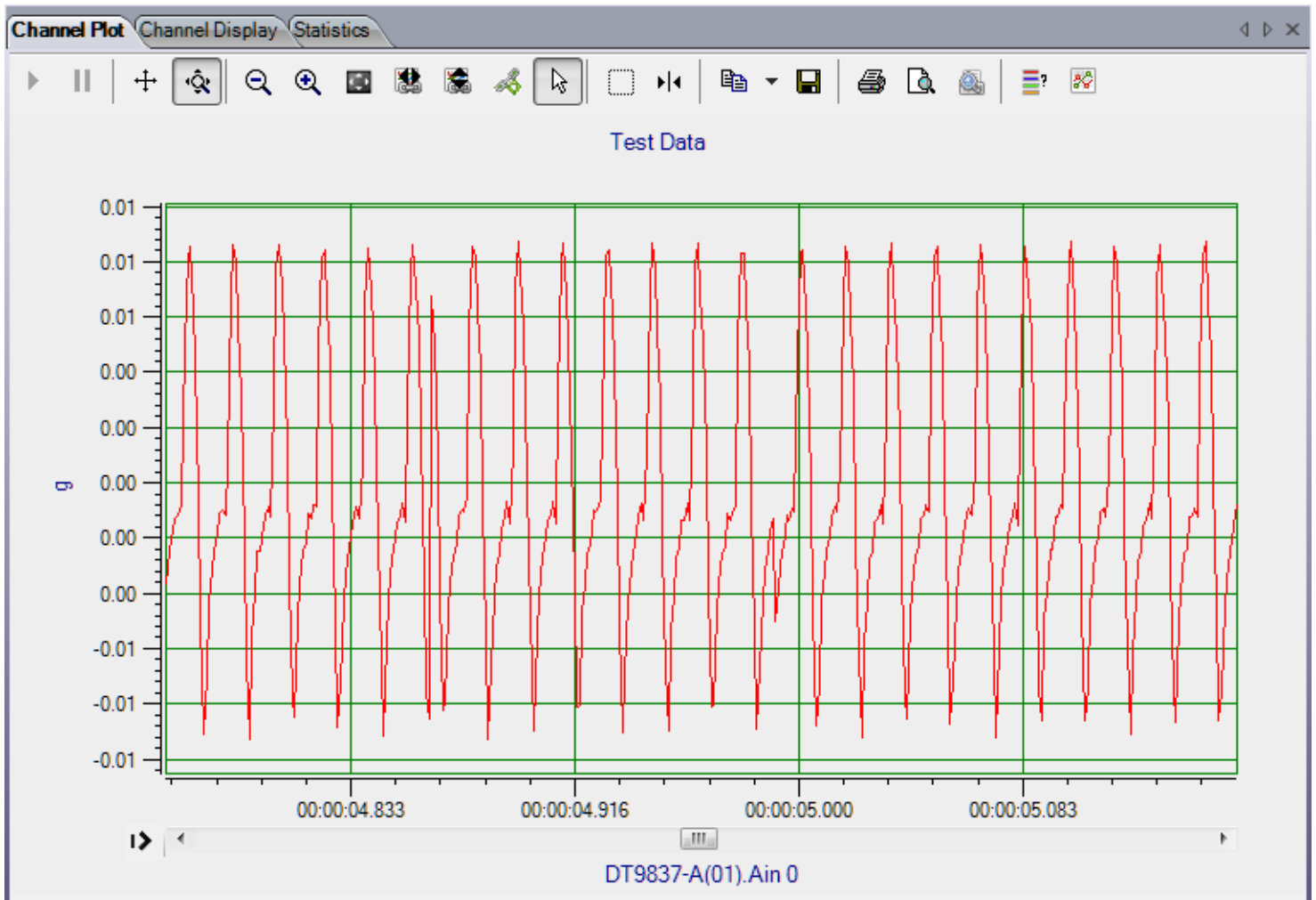

The following sections describe how to set up the scaling for the y- and x-axes on the Channel Plot window, how to use the controls provided for the Channel Plot window, and how to use the scrolling options for the Channel Plot window. Refer to [Chapter 5](#) starting on [page 169](#) for more information about the Channel Plot window.

## Setting Up the Y-Axis

If you right-click on the y-axis, the following dialog box is displayed:

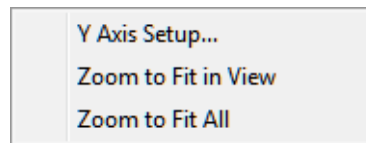

These options are described below.

### Y Axis Setup

If you select **Y Axis Setup**, the following dialog appears:

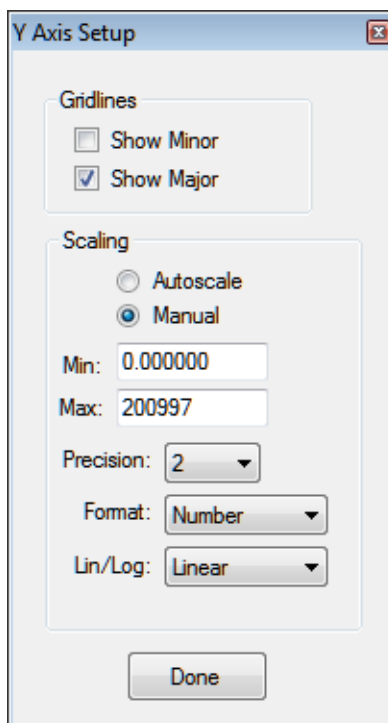

You can set up the following parameters for the y-axis:

- **Gridlines** – Select **Show Minor** if you want to display the minor gridlines on the y-axis; select **Show Major** if you want to display the major gridlines on the y-axis.
- **Scaling** – Select **Autoscale** if you want the application to determine the scale of the y-axis automatically. If you want to specify the scale of the y-axis, select **Manual** and then enter the minimum and maximum values for the y-axis.
- **Precision** – You can select the number of significant digits after the decimal point to display on the y-axis and in the cursor text; values range from 0 to 8 (2 is the default).

- **Format** – You can change for the format of the axis to see either the actual **Number** (such as 200) or the number in **Exponent** form (such as 2.0e+002).
- **Lin/Log** – For time-domain channels, you can change the y-axis of the plotted data to either **Linear** or **Log10**.

If you are using the FFT Analyzer interface and **Linear** scaling is selected for the FFT channel (using the **Data - Scaling** tab of the Plot and Data Config window), you can change the y-axis of the plotted data to either **Linear** or **Log10**. If you are using the FFT Analyzer interface and **dB** scaling is selected for the FFT channel (using the **Data - Scaling** tab of the Plot and Data Config window), this setting is not applicable.

### ***Zoom to Fit in View***

Select this menu option to scale the y-axis for the selected channel to the minimum and maximum values of the actual input signal(s) that are in the current view.

### ***Zoom to Fit All***

Select this menu option to scale the y-axis for the selected channel to the minimum and maximum values of the actual input signal(s) that were acquired, regardless of whether the data is in the current view.

## **Setting Up the X-Axis**

If you right-click on the x-axis, the following dialog box is displayed:

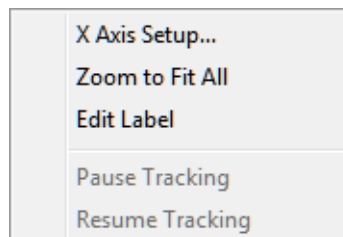

## X Axis Setup

If you select **X Axis Setup**, the following dialog appears:

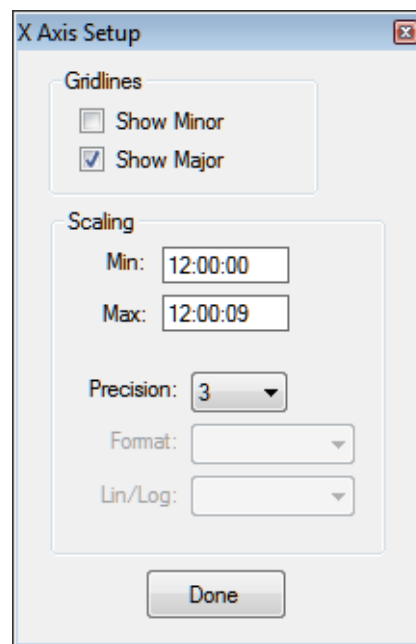

You can set up the following parameters for the x-axis:

- **Gridlines** – Select **Show Minor** if you want to display the minor gridlines on the y-axis; select **Show Major** if you want to display the major gridlines on the y-axis.
- **Scaling** – Specify the scale of the x-axis by entering the minimum and maximum values for the x-axis.
- **Precision** – You can select the number of significant digits after the decimal point to display on the x-axis and in the cursor text; values range from 0 to 8 (3 is the default).
- **Format** – If you are using the FFT Analyzer interface, you can change for the format of the x-axis to see either the actual **Number** (such as 200) or the number in **Exponent** form (such as 2.0e+002).
- **Lin/Log** – If you are using the FFT Analyzer interface, you can change the axis of the plotted data to either **Linear** or **Log10**.

## Zoom to Fit All

Select this menu option to scale the x-axis for the selected channel to the minimum and maximum values of the actual input signal(s) that were acquired.

## Edit Label

Select this menu option to change the text that is displayed for the x-axis.

## Pause Tracking

If the application is recording, you can click this popup menu option to pause tracking for a specific plot. The plot stops updating, but data is still recorded to disk. The tracking for other plots is unaffected by this action.

A specific plot can also be paused by using the scrollbar for the x-axis to scroll through the data. After tracking is paused, the scrollbar continues to be updated so that you can scroll to the data as it is being acquired.

If you want to pause tracking for all channels, use the Tracking Pause  button on the toolbar instead. Refer to [page 73](#) for more information.

While tracking is paused, you can use the controls for the Channel Plot window, described on [page 72](#), to analyze the data that was previously recorded.

## Resume Tracking

If recording is still in progress, you can resume tracking for a specific plot by clicking the Resume Tracking popup menu option. The tracking for other plots is unaffected.

To resume tracking for all plots whose tracking was paused, click the Tracking Resume  button on the toolbar. Refer to [page 72](#) for more information.

## Using the Channel Plot Window Controls

A toolbar, shown in [Figure 9](#), provides a number of controls for the Channel Plot window.



**Figure 9: Toolbar of the Channel Plot Window**

## Tracking Resume

If the application is recording and tracking was paused, you can click this button to resume tracking for all plots on the display. The display is then updated with the current data in real time.

To resume tracking on a specific plot rather than on all plots, right-click the x-axis and select the Resume Tracking popup menu option; refer to [page 72](#) for more information.



## Tracking Pause

If the application is recording, you can click this button to pause tracking on all plots of the display. The display stops updating, but data is still recorded to disk. While tracking is paused you can use the other controls to analyze the data that was previously recorded.

To pause tracking on a specific plot rather than on all plots, right-click the x-axis and select the Pause Tracking popup menu option or use x-axis scrollbar to scroll through the data; refer to [page 72](#).

## Axes Scroll

When you click this button, you can scroll through the axes by holding down the left mouse button and dragging the mouse over the axis (up and down for the y-axis, or right and left for the x-axis).

If you want to change the magnification (zoom) of the axes while this button is selected, hold down the Ctrl button while holding down the left mouse button, and drag the mouse over the axis (up and down for the y-axis, or right and left for the x-axis).

When this button is selected, the Axes Zoom button is unselected.

## Axes Zoom

When you click this button, you can change the magnification (the zoom) of the axes by holding down the left mouse button and dragging the mouse over the axis (up and down for the y-axis, or right and left for the x-axis).

When this button is selected, the Axes Scroll button is unselected.

## Zoom-Out All

When you click this button, the magnification of all axes is reduced (zoomed out) by a factor of 2.

## Zoom-In All

When you click this button, all axes are magnified (zoomed in) by a factor of 2.

## Zoom All to Fit in View Y

When you click this button, the scale of all y-axes are adjusted to the minimum and maximum values of the actual input signal(s).

### **Link X Axes to Selected**

Click the x-axis for the plot that you want to link to (the master plot), then click the **Link X Axes to selected** button to link the x-axes of all the other plots (the slave plots) with the same data domain (time domain or frequency domain). You can then use the scrolling controls on the master plot to affect the view of all the slave plots with the same data domain at the same time.

For example, assume that you have three plots (a time-domain plot in volts, a frequency-domain plot, and a time-domain plot in degrees C). If you choose the x-axis of the plot in volts and click the **Link X Axes to selected** button, the time-domain plot in volts is the master plot and the time-domain plot in degrees C is the slave plot. When you zoom into the data or scroll through the x-axis of the master plot, the application also zooms into the data or scrolls through the x-axis for the slave plot. The frequency-domain plot is unaffected.

If you zoom into or scroll through the x-axis of the slave plot, none of the other plots is affected. To resynchronize the slave plot with the master plot, either zoom into or scroll through the x-axis of the master plot, or unlink the x-axes in the master plot and relink them in the master plot using the **Link X Axes to selected** button.

### **Link Y Axes to Selected**

Click the y-axis for the plot that you want to link to (the master plot) then click the **Link Y Axes to selected** button to link the y-axes of all the other plots (the slave plots) that have the same data domain (either time domain or frequency domain). You can then use the scrolling controls on the master plot to affect the view of all the slave plots with the same data domain at the same time.

For example, assume that you have three plots (a time-domain plot in volts, a frequency-domain plot, and a time-domain plot in degrees C). If you choose the y-axis of the plot in volts and click the **Link Y Axes to selected** button, the time-domain plot in volts is the master plot and the time-domain plot in degrees C is the slave plot. When you scroll through the y-axis of the master plot, the application also scrolls through the y-axis for the slave plot. The frequency-domain plot is unaffected.

If you scroll through the y-axis in the slave plot, none of the other plots is affected. To resynchronize the slave plot with the master, either scroll through the y-axis in the master plot, or unlink the y-axes in the master plot and relink them using the **Link X Axes to selected** button.

### **Link Cursors to Selected**

Locks data cursors together so that by moving the locked data cursor, all the data cursors move together. To use this button, click the **Data-Cursor** button, click the data cursor that you want to lock to, and then click the **Link Cursors to Selected** button. Once it is locked, moving the locked data cursor moves all the data cursors.

**Select** 

When you click this button, you can select items in the view area to zoom or scroll. This is equivalent to holding down the **Ctrl** and **Alt** keys while pressing the **V** key, or selecting the **Plot** menu, selecting **Plot Area Mouse Mode**, and choosing the **Select** menu option.

**Zoom Box** 

When you click this button, you can select a region in the view to magnify (zoom) by holding down the left mouse button, dragging the mouse to select the region that you want to magnify, and releasing the mouse button. The zoom action affects both axes.

This is equivalent to holding down the **Ctrl** and **Alt** keys while pressing the **Z** key, or selecting the **Plot** menu, selecting **Plot Area Mouse Mode**, and choosing the **Zoom** menu option.

**Data-Cursor** 

When you click this button, you can move the position of a data-cursor on the curve by holding down the left mouse button and dragging the mouse.

This is equivalent to holding down the **Ctrl** and **Alt** keys while pressing the **C** key, or selecting the **Plot** menu, selecting **Plot Area Mouse Mode**, and choosing the **Cursor** menu option.

When the **Data-Cursor** is active, right-click the mouse to change the cursor style, line style, and/or color of the cursor; the following menu appears:

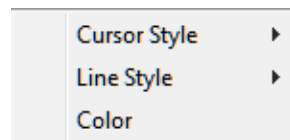

You can change the cursor style to one of the following settings:

- **Value-XY** – Choose this style to display a single value at a particular point on the X- and Y-axes.
- **Period** – Choose this style to display the period, in seconds, between two vertical cursors. You can drag each cursor independently.
- **Frequency** – Choose this style to display the frequency, in Hertz, between two vertical cursors. You can drag each cursor independently.
- **Peak-Peak** – Choose this style to display the value between two horizontal cursors. This is the number of volts or sensor units. You can drag each cursor independently.

- **Band Power** – Available with the FFT Analysis and Advanced FFT Analysis options. When the spectrum function (selected on the **Data - Function** tab of the Plot and Data Config window) is **AutoSpectrum** or **PSD**, and the scaling type is **Linear** (selected on the **Data - Scaling** tab of the Plot and Data Config window), select this style to display the square root of the sum of the values between the cursor lines.

When the spectrum function (selected on the **Data - Function** tab of the Plot and Data Config window) is **Spectrum**, and the scaling type is **Linear** (selected on the **Data - Scaling** tab of the Plot and Data Config window), select this style to display the square root of the sum of the squared values between the cursor lines.

The following example shows a period data cursor, where two data cursors show the period, in seconds, between two data points:

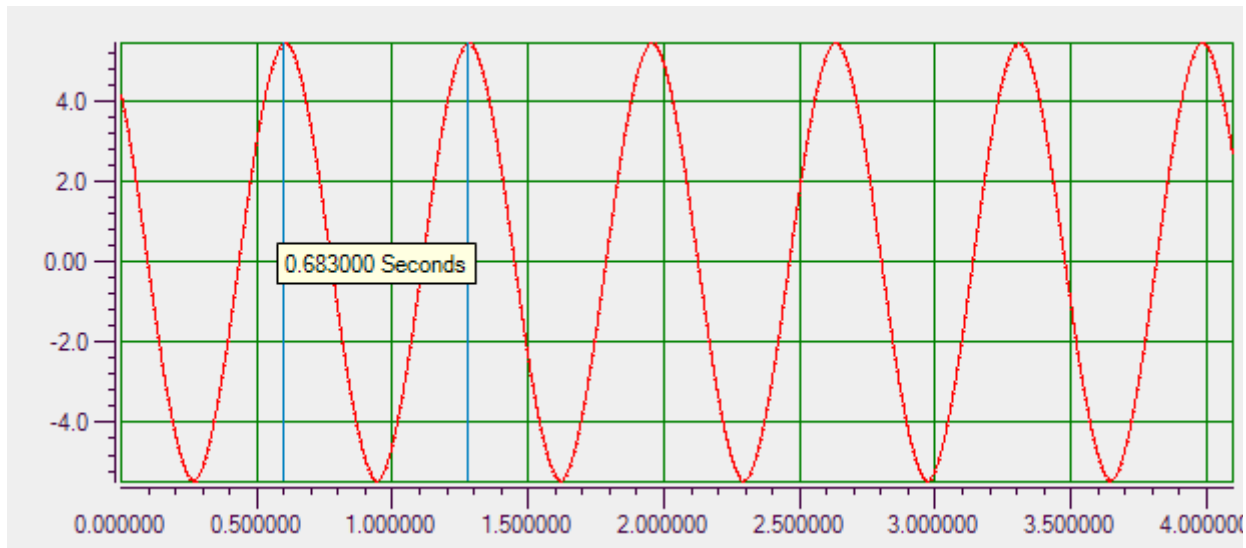

You can change the line style to one of the following settings:

- **Solid** – Choose this style to display the cursors as solid lines.
- **Dash** – Choose this style to display the cursors as a dashed lines.
- **Dot** – Choose this style to display the cursors as a dotted lines.
- **DashDot** – Choose this style to display the cursors as lines of dash-dot elements.

You can change the color of the cursors to one of the provided basic colors or to any custom color you desire.

**Copy to Clipboard**  ▼

When you click this button, you can copy either the graph (the picture) or the data that is displayed in the Channel Plot window to the clipboard.

**Save Plot Image** 

When you click this button, you can save the image from the Channel Plot window to a file. Specify the name of the file and choose one of the extensions to save the file as a graphic.

The default location for saving the image files is as follows:

*For Windows Vista, Windows 7, or Windows 8:*

C:\Users\\AppData\Local\Data Translation\QuickDAQ\Data

*For Windows XP:*

C:\Documents and Settings\\Local Settings\Application Data\Data Translation\QuickDAQ\Data

**Print** 

When you click this button, you can print the picture from the Channel Plot window to a printer.

**Preview** 

When you click this button, you can preview the image from the Channel Plot window before you print it.

**Page Setup** 

When you click this button, you can configure the page before you print it. Options are available for configuring the size, orientation, and margins of the page.

**Show Legend** 

When you click this button, you can show or hide the legend that defines the colors used for each channel on the plot. An example follows:

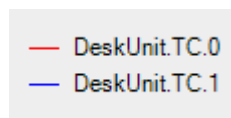
**Show Data Point Markers** 

When you click this button, you can show or hide markers that indicate the actual samples on the curve, as shown in the following example. The diamond markers indicate the actual samples.

If you click on a data point marker, a label for the channel is displayed.

**Note:** When moving the data-cursor with the data point markers shown, the data-cursor snaps to the closest sample on the curve.

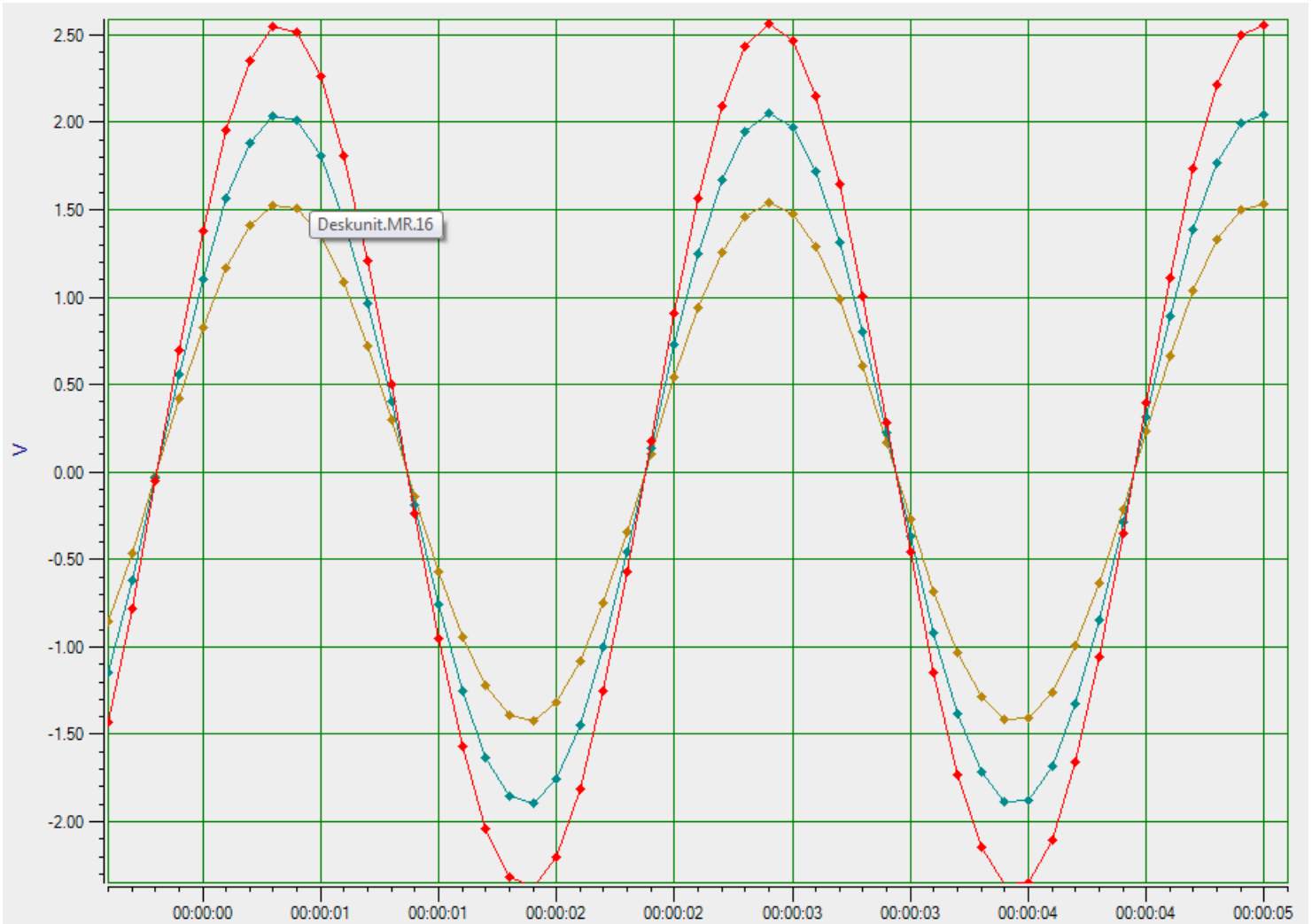

### Zoom Options that Apply to the Current Plot

If you have multiple plots and want to have different zoom settings for one or more of them, use the popup zoom control buttons on the left side of the scrollbar under the current plot. The scrollbar is shown below:







If you click on the Hide/Show Zoom Control button  on the left side of the scrollbar, the following zoom control buttons are shown:



You can use these zoom control buttons to modify the zoom options for the current plot.

The buttons are described as follows:

- Undo  – Click on this button to undo the last zoom or move.
- Zoom Full Out  – Click this button to zoom out so that all data fits in the plot.
- Zoom In X  (Ctrl-click to Zoom Out X) – Click this button to zoom in on the data on the x-axis, or press the Ctrl key and click this button to zoom out on the data on the x-axis.
- Zoom In Y  (Ctrl-click to Zoom Out Y) – Click this button to zoom in on the data on the y-axis, or press the Ctrl key and click this button to zoom out on the data on the y-axis.
- View Plot Full Screen  – Click this button to view the plot in full screen. If you click this button again, the plot will be shown in its original size.

## Scrolling Options

If you right-click on the scrollbar of the x-axis, the following dialog box is displayed:

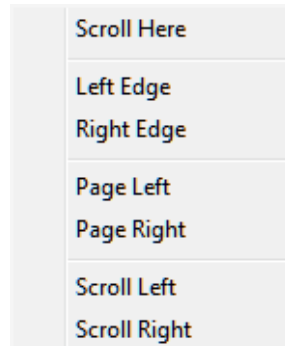

The options are as follows:

- **Scroll Here** – Moves the scroll bar to the point of the mouse click that opened the scroll bar dialog.
- **Left Edge** – Moves the scroll bar to the left edge of the acquired data.
- **Right Edge** – Moves the scroll bar to the right edge of the acquired data.
- **Page Left** – Updates the content of the scroll area with the page of data to the left of the data is currently being displayed.
- **Page Right** – Updates the content of the scroll area with the page of data to the right of the data is currently being displayed.
- **Scroll Left** – Scrolls to the left.

- **Scroll Right** – Scrolls to the right.



## Channel Display Window

You can access the Channel Display window by clicking the **Channel Display** tab in the display area of the interface or by clicking the **Channel Display** menu option under the **Windows** menu.

During acquisition, the newest value for each enabled channel is displayed in the Channel Display window in real time. The Channel Display window allows you to view data from your device in a digital display. By default, the layout represents the channel locations on the front panel of the device. Refer to [Chapter 5](#) starting on [page 169](#) for more information about the Channel Display window.



## Statistics Window

You can access the Statistics window by clicking the **Statistics** tab in the display area of the interface or by clicking the **Channel Statistics** menu option under the **Windows** menu.

Statistics are handled differently depending on the interface mode you selected, as described below.

### Statistics in the Data Logger Interface

If you are using the Data Logger interface, statistics are displayed in the Statistics window in real time as data is acquired, provided that the **Visible Statistics** checkbox in the Plot and Data Config window is selected for the channel.

The Statistics window shows the minimum, maximum, and mean values of the data, along with the difference between the minimum and maximum values (called the delta) and the standard deviation for each enabled channel:

Ch #	Channel	Min	Max	Delta	Mean	Std Dev
0	DT9837-C(00) Ain 0	-1.034621	1.02277756	2.05739856	-0.0005255	0.20240895

In file-reader mode, the results are read from the file and the statistics are shown in the Statistics window.

---

**Note:** To save the data that is displayed in the Statistics window, either take a screen shot of the Statistics window or click the Statistics tab, press Ctrl-A (to select all listed channels), and press Ctrl-C to paste the data into another application.

---

Refer to [page 188](#) for more information about statistics in the Data Logger interface.

### Statistics in the FFT Analyzer Interface

If you are using the FFT Analyzer interface, the statistics that you select using the **Stats** tab, described on [page 236](#), are displayed in the Statistics window in real time as data is acquired, provided that the **Visible Statistics** checkbox in the Plot and Data Config window is selected for the channel.

In file-reader mode, the results are read from the file and the statistics that you selected using the **Stats** tab are shown in the Statistics window:

Ch #	Channel	Min	Max	Delta	Mean	Std Dev	IBF (dB)	THD	SFDR (dB)	SINAD (dB)	SNR (dB)	ENOB (bits)
0	DT9837-C(00).Ain 0	-1.034621	1.02277756	2.05739856	-0.0005255	0.20240895	-30.76	0.0188%, -74.52db	96.54	60.449	63.052	14.86

Using the **Stats** tab, you can choose to display the following statistics for the enabled channels:

- Minimum value, maximum value, mean value, delta of minimum and maximum values, and standard deviation statistics
- Dynamic statistics – Allows you to quantify the analog characteristics of the data that is acquired through the A/D converter on the device. You can select either RMS (Root Mean Squared) or Vector averaging to compute the following statistics:
  - IBF – Input Below Full-Scale
  - THD – Total Harmonic Distortion
  - SFDR – Spurious Free Dynamic Range
  - SINAD – Signal-to-Noise And Distortion
  - SNR – Signal-to-Noise Ratio
  - ENOB – Effective Number of Bits

---

**Note:** To save the data that is displayed in the Statistics window, either take a screen shot of the Statistics window or click the Statistics tab, press Ctrl-A (to select all listed channels), and press Ctrl-C to past the data into another application.

---

Refer to [page 236](#) for more information about statistics in the FFT Analyzer interface.

## Acquisition Status Window

The Acquisition Status window, located under the Channel Plot, Channel Display, and Statistics windows, contains different information depending on the interface mode you are using, as described below.

### Acquisition Status Window When Using the Data Logger Interface

If you are using the Data Logger interface, the Acquisition Status window shows the status of the device, including whether the device is acquiring data or idle and how many scans have been completed.

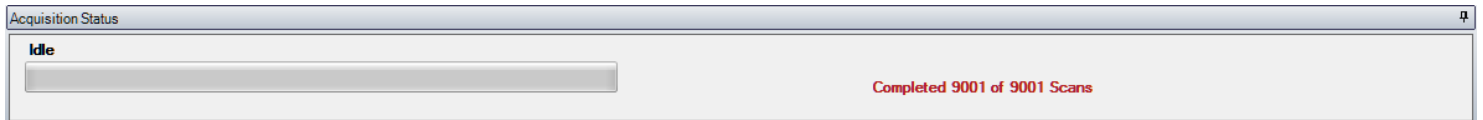

### Acquisition Status Window When Using the FFT Analyzer Interface

If you are using the FFT Analyzer interface, the Acquisition Status window shows the status of the device, as well as the **Record Number** and the **Link Time Series Data** checkbox, described on [page 229](#), and the **Accept** and **Reject** buttons, described on [page 136](#).

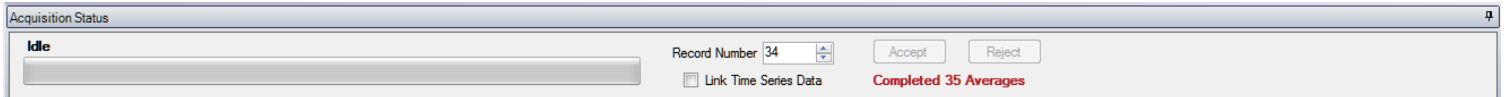



# ***Configuring Channels, Acquisition Settings, and Digital Filters***

Configuring Channels of a Device.....	86
Configuring the Settings of the Recording Tab .....	121
Configuring the Settings of the Acquisition Tab (Data Logger Interface Only) .....	127
Configuring the Settings of the Freq Tab (FFT Analyzer Interface Only) .....	130
Configuring the Settings of the Trigger Tab (FFT Analyzer Interface Only).....	133
Configuring the Settings of the Window Tab (FFT Analyzer Interface Only).....	137
Configuring the Settings of the Output Tab .....	140
Configuring Digital Filters .....	164

## Configuring Channels of a Device

**Notes:** To configure the channels, you must have selected a supported device or have opened an .hpf file that contains configuration settings for a supported device.

You can change the following settings in an .hpf file: Channel Name, Ref/Resp (Advanced FFT Analysis option only), EU, mv/EU, and EU offset; once you've changed these settings, you can reprocess the data with the changes

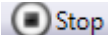
If acquisition is in progress, you must choose **Stop** from the **Record** menu or click the **Stop** toolbar button (  ) before you can change the configuration of a device.

Choose the **Input Channel Configuration** toolbar button (  ) or the **Input Channel Configuration** option from the **Configuration** menu to configure the channels from which to acquire data in the analog input data stream. The Configure Devices dialog appears.

The elements of the Configure Devices dialog depend on the specified device. For example, [Figure 10](#) shows the Configure Devices dialog for a MEASURpoint instrument:

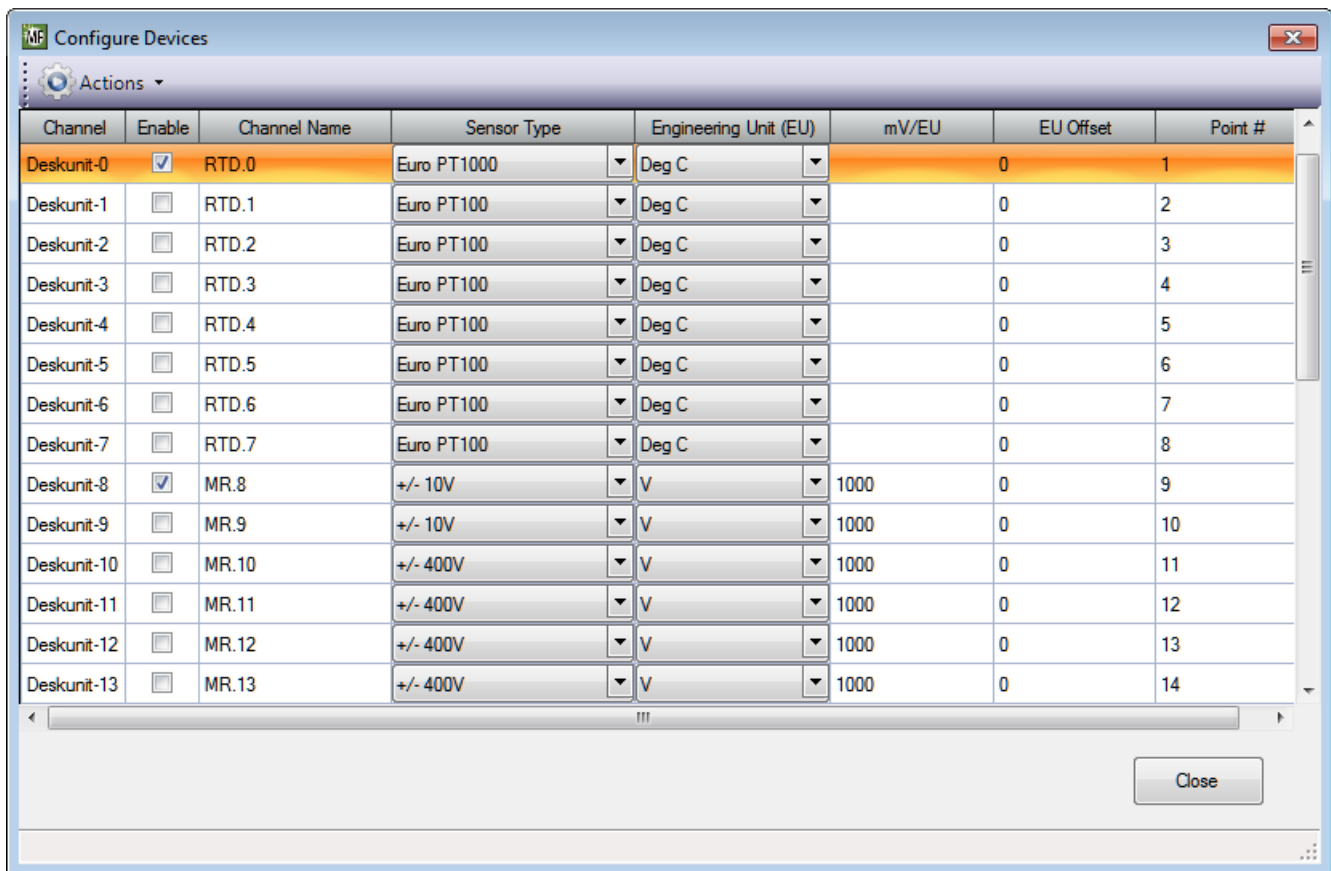

**Figure 10: Example Configuration of a MEASURpoint Instrument**

Figure 11 shows an example configuration for the DT9836.

**Analog Input Channels**

Channel	Enable	Channel Name	Engineering Unit (EU)	mV/EU	EU Offset	Point #
DT9836(00)-0	<input checked="" type="checkbox"/>	Ain 0	V	1000	0	1
DT9836(00)-1	<input type="checkbox"/>	Ain 1	V	1000	0	2
DT9836(00)-2	<input type="checkbox"/>	Ain 2	V	1000	0	3
DT9836(00)-3	<input type="checkbox"/>	Ain 3	V	1000	0	4
DT9836(00)-4	<input type="checkbox"/>	Ain 4	V	1000	0	5
DT9836(00)-5	<input type="checkbox"/>	Ain 5	V	1000	0	6
DT9836(00)-6	<input type="checkbox"/>	Ain 6	V	1000	0	7
DT9836(00)-7	<input type="checkbox"/>	Ain 7	V	1000	0	8
DT9836(00)-8	<input type="checkbox"/>	Ain 8	V	1000	0	9
DT9836(00)-9	<input type="checkbox"/>	Ain 9	V	1000	0	10
DT9836(00)-10	<input type="checkbox"/>	Ain 10	V	1000	0	11
DT9836(00)-11	<input type="checkbox"/>	Ain 11	V	1000	0	12
DT9836(00)-12	<input type="checkbox"/>	Din 0				

**Counter Channels**

Channel	Enable	Channel Name	Engineering Unit (EU)	Max mSec/Hz	Start Edge
DT9836(00)-13	<input type="checkbox"/>	Counter 0	Hz	1000	Gate Rising
DT9836(00)-14	<input type="checkbox"/>	Counter 1	Hz	1000	Gate Rising

**Quadrature Channels**

Channel	Enable	Channel Name	Engineering Unit (EU)	Pulses/Rev	Clock PreScale	Index Mode	X4 Scaling
DT9836(00)-15	<input type="checkbox"/>	Quad 0	Deg	100	1	Disabled	<input type="checkbox"/>
DT9836(00)-16	<input type="checkbox"/>	Quad 1	Deg	100	1	Disabled	<input type="checkbox"/>
DT9836(00)-17	<input type="checkbox"/>	Quad 2	Deg	100	1	Disabled	<input type="checkbox"/>

Close

Figure 11: Example Configuration of a DT9836 Module

Figure 12 shows an example configuration for the DT9837C.

**Note:** The Ref/Resp heading appears only if you are using the Advanced FFT Analysis option of QuickDAQ.

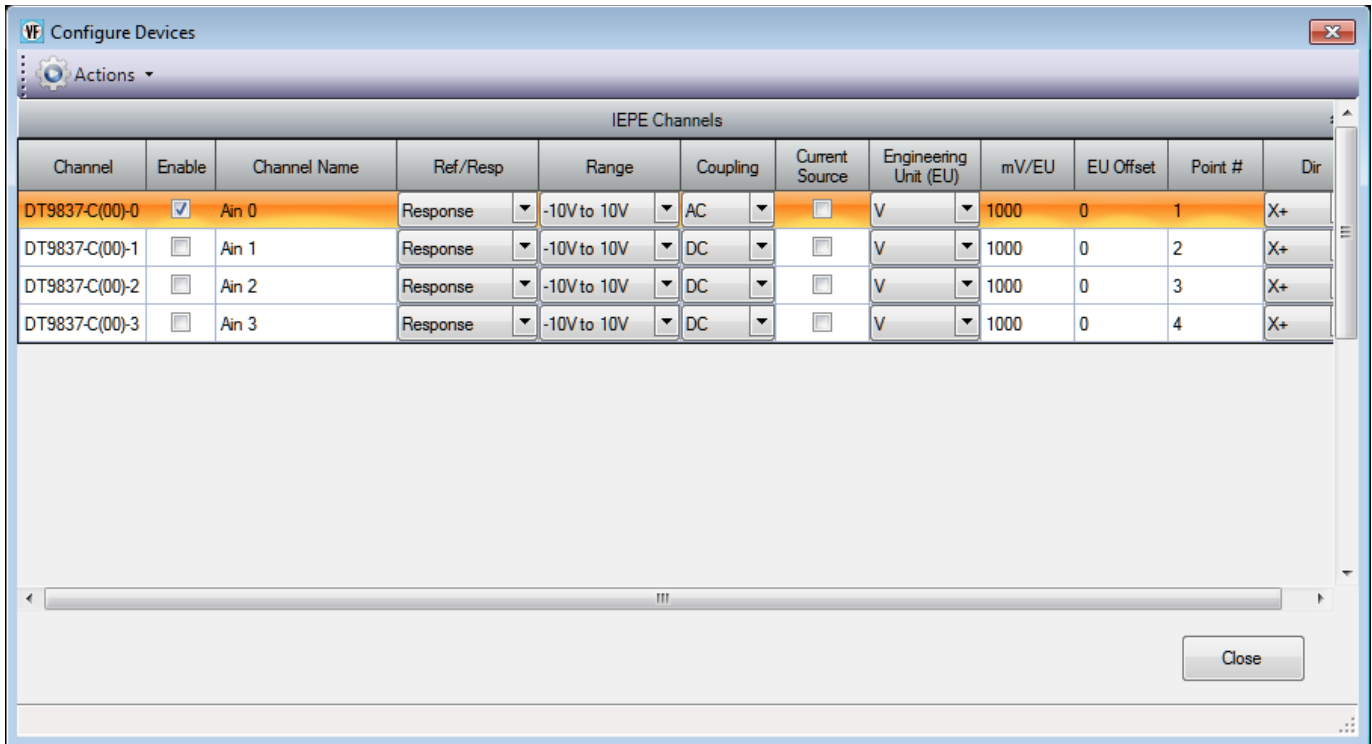

Figure 12: Example Configuration for the DT9837C



Figure 13 shows an example configuration for the DT9829.

Channel	Enable	Channel Name	Input Type	Sensor Type	RTD R0	A Coeff	B Coeff	C Coeff	Resistance Range	Sensor Wiring	Range	Engineering Unit (EU)	mV/EU	EU Offset	Enable Termination Resistor	Configure and Calibrate Strain and Bridge	Point #
DT9829(00)-0	<input checked="" type="checkbox"/>	An 0	VoltageInput								-10V to 10V	V	1000	0	<input type="checkbox"/>		1
DT9829(00)-1	<input checked="" type="checkbox"/>	An 1	Current									mAmps	0	0	<input type="checkbox"/>		2
DT9829(00)-2	<input checked="" type="checkbox"/>	J Thermocouple	Thermocouple	Type J								Celsius	0	0	<input type="checkbox"/>		3
DT9829(00)-3	<input type="checkbox"/>	An 3	RTD	Pt3750	1000	3.810e-3	-6.020e-7	-6.000e-12		FourWire		Celsius	0	0	<input type="checkbox"/>		4
DT9829(00)-4	<input type="checkbox"/>	An 4	StrainGage									uS	0	0	<input type="checkbox"/>	Configure and Calibrate	5
DT9829(00)-5	<input type="checkbox"/>	An 5	Bridge									lbf	0	0	<input type="checkbox"/>	Configure and Calibrate	6
DT9829(00)-6	<input type="checkbox"/>	An 6	Thermistor			1.032e-3	2.387e-4	1.580e-7		FourWire		Deg C	0	0	<input type="checkbox"/>		7
DT9829(00)-7	<input checked="" type="checkbox"/>	An 7	Resistance						0-4kΩ	FourWire		Ohms	0	0	<input type="checkbox"/>		8
DT9829(00)-8	<input type="checkbox"/>	Din 0										Bits			<input type="checkbox"/>		9

Figure 13: Example Configuration for the DT9829

## Enabling Channels

Select the channels that you want to enable for acquisition by clicking the checkbox under the **Enable** column. Only data from the enabled channels is included in the analog input data stream.

---

**Note:** For the DT9805 and DT9806 modules, the CJC channel is enabled automatically if any of the analog input channels are configured for a temperature sensor type. You can disable this channel, if desired.

---

If you want to enable all the channels at once, click the **Multi-channel Actions** button (  **Actions** ) and then click **Enable all Channels**. If you want to enable several but not all channels at once, highlight the channels that you want to enable, click the **Multi-channel Actions** button, and then click **Enable all Selected Channels**.

If you want to disable all the channels at once, select the **Multi-channel Actions** button, and then click **Disable all Channels**. If you want to disable several but not all channels at once, highlight the channels that you want to disable, click the **Multi-channel Actions** button, and then click **Disable all Selected Channels**.

## Channel Name

For each channel, you can specify a meaningful name for each channel, if desired, by highlighting the channel under the **Channel Name** column and entering a new name.

## Input Type

For devices that support multiple sensor types for each channel, you can configure the type of measurement to perform for the channel using the **Input Type** column. If you are using the DT9829 module, for example, you can choose from one of the following selections: VoltageInput, Current, Thermocouple, RTD, Strain Gage, Bridge, Thermistor, or Resistance.

If your device supports dedicated measurement types for each channel, the **Input Type** column does not appear.

### ***Ref/Resp***

If you are using the Advanced FFT Analysis option of QuickDAQ and you want to use a two-channel FFT function, select **Reference** for the channel that will create the stimulus, and select **Response** for the channels that will measure the effect of the stimulus. You must select at least one enabled analog input channel as the **Reference** channel.

You can then compare the spectrum of the response channel to the spectrum of the reference channel by adding a two-channel FFT function to the list of channels. Refer to [page 204](#) for more information about adding two-channel FFT functions.

## Analog Input Channel Settings for Devices that Support Voltage

This section describes the settings that you can configure for the analog input channels on your device.

### ***Sensor Type***

This setting is only available for MEASURpoint instruments. To measure voltage from a thermocouple or RTD channel on a MEASURpoint instrument, select **Volts** as the Sensor Type.

### ***Range***

If your device supports multiple input ranges, set the input range for each analog input channel.

For example, the following devices support multiple input ranges:

- DT8874, DT9847, DT8873, and DT9873 instruments:  $\pm 10$  V,  $\pm 100$  V, or  $\pm 400$  V
- DT8875 instruments:  $\pm 10$  V,  $\pm 100$  V, or  $\pm 600$  V
- DT8876 instruments:  $\pm 100$  mV,  $\pm 1.0$  V, or  $\pm 10$  V
- DT8824 instrument modules:  $\pm 10$  V,  $\pm 1.25$  V,  $\pm 0.625$  V, or  $\pm 0.3125$  V

- DT8824-HV instrument modules:  $\pm 600$  V,  $\pm 75$  V,  $\pm 37.5$  V, or  $\pm 18.75$  V
- DT9829 modules:  $\pm 10$  V,  $\pm 2$  V, or  $\pm 0.2$  V

If you want to specify the same voltage range for all multi-range channels, click the **Multi-channel Actions** button (  Actions ▾ ), select **Set all Multi-Range Channels**, and select the specific voltage range.

### Engineering Unit (EU)

For voltage inputs, you can choose **Volts** or one of the following engineering units to display the data, based on the sensor that is attached to the channel:

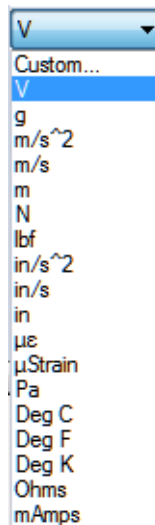

If you select **Custom**, you can define your own engineering units.

If you want to specify the same engineering units for all voltage channels, click the **Multi-channel Actions** button (  Actions ▾ ), select **Set all Voltage Channel Units**, and select the specific engineering units to use from the list above.

If you want to set the engineering units for some but not all analog input channels at once, select the **Multi-channel Actions** button, click **Set all Selected Channel Units**, and select the desired engineering units.

### mV/EU

Enter the number of millivolts per engineering unit (mV/EU) by which to scale the raw voltage based on the engineering units that you selected.

### EU Offset

You can enter an offset (EU Offset) value to add to the scaled signal.

## **Enable Termination Resistor**

Some devices support the option of enabling the bias return termination resistor for voltage inputs. Typically, this box should be checked (termination resistor is enabled) when your signal source is floating or grounded, and should be unchecked (termination resistor is disabled) when the signal source has a grounded reference.

Refer to your hardware documentation for more information on whether to enable or disable this resistor.

## **Point #**

If desired, you can enter a number representing the test point to which this channel corresponds. By default, values start at 1 and increment with each channel.

## **Analog Input Channel Settings for Devices that Support Thermocouples**

This section describes the analog input settings that you can configure for devices, such as the MEASURpoint instruments, DT9829 modules, and DT9805/DT9806 modules, that support thermocouples.

### **Sensor Type**

Select the type of thermocouple that is connected to each channel under the **Sensor Type** column. Values are as follows:

- Type B
- Type E
- Type J
- Type K
- Type N
- Type R
- Type S
- Type T
- Volts (if you want to measure voltage instead; refer to [page 90](#) for more information on configuring channels for voltage measurements)

If you want to specify the same thermocouple type for all channels, click the **Multi-channel Actions** button (  **Actions** ▾ ), select **Set all Thermocouple Channels**, and select the specific thermocouple type.

## **Engineering Unit (EU)**

For channels that are configured for thermocouple inputs, the data is returned in Celsius, Fahrenheit, or Kelvin. You select the engineering units using the Acquisition Config tab, described on [page 129](#).

If you selected a **Sensor Type** of Volts, refer to [page 91](#) for more information.

## **EU Offset**

You can enter an offset (EU Offset) value to add to the scaled signal.

## **Point #**

If desired, you can enter a number representing the test point to which this channel corresponds. By default, values start at 1 and increment with each channel.

## **Analog Input Channel Settings for Devices that Support RTDs**

This section describes the analog input settings that you can configure for devices, such as the MEASURpoint instruments and DT9829 modules, that support RTDs.

### **Sensor Type**

The available choices for **Sensor Type** depend on whether you are using RTDs on a MEASURpoint instrument (which uses an IVI-COM driver) or other devices, such as the DT9829 module, which use a DT-Open Layers device driver.

#### **Sensor Type Selections for MEASURpoint Instruments**

If you are using a MEASURpoint instrument, the following sensor types are available for RTD channels:

- Euro PT1000 (for 2- and 4-wire RTDs)
- Euro PT500 (for 2- and 4-wire RTDs)
- Euro PT100 (for 2- and 4-wire RTDs)
- American PT1000 (for 2- and 4-wire RTDs)
- American PT500 (for 2- and 4-wire RTDs)
- American PT100 (for 2- and 4-wire RTDs)
- Euro PT1000 3 Wire (for 3-wire RTDs)
- Euro PT500 3 Wire (for 3-wire RTDs)
- Euro PT100 3 Wire (for 3-wire RTDs)
- American PT1000 3 Wire (for 3-wire RTDs)
- American PT500 3 Wire (for 3-wire RTDs)
- American PT100 3 Wire (for 3-wire RTDs)

- Ohms (if you want to measure resistance instead; refer to [page 97](#) for more information on configuring channels for resistance measurements)
- Volts (if you want to measure voltage instead; refer to [page 90](#) for more information on configuring channels for voltage measurements)

If you want to specify the same RTD type for all channels, click the **Multi-channel Actions** button (  **Actions** ▾ ), select **Set all RTD Channels**, and select the specific RTD type.

### Sensor Type Selections for the DT9829 and Other DT-Open Layers Devices

If you are using a DT9829 module or any other device that uses a DT-Open Layers device driver, the following sensor types are available for RTD channels:

- Custom
- Pt3750
- Pt3850
- Pt3911
- Pt3916
- Pt3920
- Pt3928

The **Sensor Type** identifies the Temperature Coefficient of Resistance (TCR) value that is used by the Callendar-Van Dusen transfer function to determine temperature for RTDs. The Callendar-Van Dusen transfer function is described as follows:

$$R_T = R_0[1 + AT + BT^2 + CT^3(T - 100)]$$

where,

- $R_T$  is the resistance at temperature (TCR).
- $R_0$  is the resistance at 0° C.
- A, B, and C are the Callendar-Van Dusen coefficients for a particular RTD type. (The value of C is 0 for temperatures above 0° C.)

[Table 1](#) lists the coefficients that are used by the Callendar-Van Dusen transfer function for each **Sensor Type**.

**Table 1: Callendar-Van Dusen Coefficients Supported By RTD Channels**

Sensor Type	Temperature Coefficient of Resistance (TCR)	R0 Coefficient	A Coefficient	B Coefficient	C Coefficient	Applicable Standards
Pt3750	0.003750 $\Omega / \Omega / ^\circ \text{C}$	1000 $\Omega$	$3.81 \times 10^{-3}$	$-6.02 \times 10^{-7}$	$-6.0 \times 10^{-12}$	Low Cost
Pt3850	0.003850 $\Omega / \Omega / ^\circ \text{C}$	100 $\Omega$ , 500 $\Omega$ , 1000 $\Omega$	$3.9083 \times 10^{-3}$	$-5.775 \times 10^{-7}$	$-4.183 \times 10^{-12}$	DIN/IEC 60751 ASTM-E1137
Pt3911	0.003911 $\Omega / \Omega / ^\circ \text{C}$	100 $\Omega$	$3.9692 \times 10^{-3}$	$-5.8495 \times 10^{-7}$	$-4.233 \times 10^{-12}$	US Industrial Standard
Pt3916	0.003916 $\Omega / \Omega / ^\circ \text{C}$	100 $\Omega$	$3.9739 \times 10^{-3}$	$-5.870 \times 10^{-7}$	$-4.4 \times 10^{-12}$	Japanese JISC 1604-1989
Pt3920	0.003920 $\Omega / \Omega / ^\circ \text{C}$	98.129 $\Omega$	$3.9787 \times 10^{-3}$	$-5.869 \times 10^{-7}$	$-4.167 \times 10^{-12}$	SAMA RC21-4-1966
Pt3928	0.003928 $\Omega / \Omega / ^\circ \text{C}$	100 $\Omega$	$3.9888 \times 10^{-3}$	$-5.915 \times 10^{-7}$	$-3.85 \times 10^{-12}$	ITS-90

If you specify the **Sensor Type** as **Custom**, you must specify the values for the R0, A, B, and C coefficients used in the transfer function.

### **RTD R0**

This setting is not available for MEASURpoint instruments. For all other devices, specify the appropriate R0 coefficient for the selected **Sensor Type**. This value is used by Callendar-Van Dusen transfer function to determine temperature.

For example, for a **Sensor Type** of Pt3929, select 100  $\Omega$  as the **RTD R0** value.

### **A Coeff**

This setting is not available for MEASURpoint instruments. For all other devices, specify the appropriate A coefficient for the selected **Sensor Type**. This value is used by Callendar-Van Dusen transfer function to determine temperature.

For example, for a **Sensor Type** of Pt3929, select  $39.888\text{e-}4$  as the **A Coeff** value.

### **B Coeff**

This setting is not available for MEASURpoint instruments. For all other devices, specify the appropriate B coefficient for the selected **Sensor Type**. This value is used by Callendar-Van Dusen transfer function to determine temperature.

For example, for a **Sensor Type** of Pt3929, select  $-59.15\text{e-}8$  as the **B Coeff** value.

### **C Coeff**

This setting is not available for MEASURpoint instruments. For all other devices, specify the appropriate C coefficient for the selected **Sensor Type**. This value is used by Callendar-Van Dusen transfer function to determine temperature.

For example, for a **Sensor Type** of Pt3929, select  $-38.5e-13$  as the **C Coeff** value.

### **Sensor Wiring**

This setting is not available for MEASURpoint instruments. For all other devices, specify the wiring configuration that is used to connect the RTD to the analog input channel. Available selections are TwoWire, ThreeWire, and FourWire.

### **Engineering Unit (EU)**

For RTD inputs, the data is returned in Celsius, Fahrenheit, or Kelvin. You select the engineering units using the **Acquisition Config** tab, described on [page 129](#).

If you selected a **Sensor Type** of Ohms for a MEASURpoint instrument, refer to [page 97](#). If you selected a **Sensor Type** of Volts for a MEASURpoint instrument, refer to [page 91](#).

### **EU Offset**

You can enter an offset (EU Offset) value to add to the scaled signal.

### **Point #**

If desired, you can enter a number representing the test point to which this channel corresponds. By default, values start at 1 and increment with each channel.

## **Analog Input Channel Settings for Devices that Support Thermistors**

This section describes the analog input settings that you can configure for devices, such as the DT9829 modules, that support thermistors.

### **A Coeff, B Coeff, and C Coeff**

To determine the temperature of a thermistor, the software uses the Steinhart-Hart equation:

$$\frac{1}{T} = A + B \ln R + C \ln(R)^3$$

where,

- T is the temperature.
- R is the resistance at T, in ohms, that is supplied by the device.



- A, B, and C are the Steinhart-Hart coefficients for a particular thermistor type and value, and are supplied by the thermistor manufacturer.

Using software, you specify the A coefficient under the **A Coeff** column, the B coefficient under the **B Coeff** column, and the C coefficient under the **C Coeff** column.

### **Sensor Wiring**

Specify the wiring configuration that is used to connect the thermistor to the analog input channel. Available selections are TwoWire, ThreeWire, and FourWire.

### **Engineering Unit (EU)**

For thermistors, the data is returned in Celsius, Fahrenheit, or Kelvin. You select the engineering units using the **Acquisition Config tab**, described on [page 129](#).

### **EU Offset**

You can enter an offset (EU Offset) value to add to the scaled signal.

### **Point #**

If desired, you can enter a number representing the test point to which this channel corresponds. By default, values start at 1 and increment with each channel.

## **Analog Input Channel Settings for Devices that Support Resistance**

This section describes the analog input settings that you can configure for devices, such as MEASURpoint instruments and DT9829 modules, that support resistance.

### **Sensor Type**

This setting is only available for MEASURpoint instruments.

To measure resistance from a channel on a MEASURpoint instrument, select **Ohms** as the Sensor Type.

### **Resistance Range**

This setting is not available for MEASURpoint instruments. For all other devices, specify the range of the resistor that you are trying to measure.

For example, the DT9829 module provides the following ranges: 0 to 4 k $\Omega$  and 4k $\Omega$  to 20 k $\Omega$ .

## Sensor Wiring

This setting is not available for MEASURpoint instruments. For all other devices, specify the wiring configuration that is used to connect the resistor to the analog input channel. Available selections are TwoWire, ThreeWire, and FourWire.

## Engineering Unit (EU)

For resistance measurements, you can choose **Ohms** or one of the following engineering units to display the data:

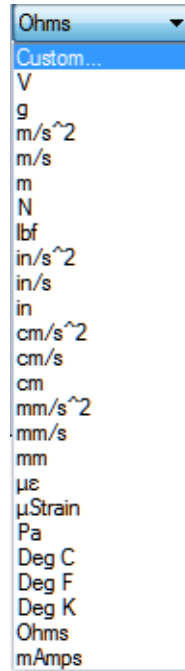

## EU Offset

You can enter an offset (EU Offset) value to add to the scaled signal.

## Point #

If desired, you can enter a number representing the test point to which this channel corresponds. By default, values start at 1 and increment with each channel.

## Analog Input Channel Settings for Devices that Support Current

This section describes the analog input settings that you can configure for devices, such as DT9829 modules, that support current measurements.

### Engineering Unit (EU)

For current measurements, you can choose **mAmps** or one of the following engineering units to display the data:

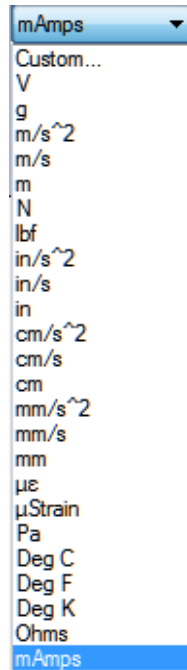

### EU Offset

You can enter an offset (EU Offset) value to add to the scaled signal.

### Enable Termination Resistor

Some devices support the option of enabling the bias return termination resistor for current inputs. Typically, this box should be checked (termination resistor is enabled) when your signal source is floating or grounded, and should be unchecked (termination resistor is disabled) when the signal source has a grounded reference.

Refer to your hardware documentation for more information on whether to enable or disable this resistor.

### Point #

If desired, you can enter a number representing the test point to which this channel corresponds. By default, values start at 1 and increment with each channel.

## Analog Input Channel Settings that Support IEPE Inputs

This section describes the settings that you can configure for devices, such as the DT8837, DT9837 Series, DT9847 Series, and DT9857 Series devices that support IEPE inputs on the analog input channels.

### **Range**

Set the input range for each analog input channel.

### **Coupling Type**

Select **AC** (AC coupling) to remove any DC offset from your measurement, or select **DC** (DC coupling) if the signal source has no offset voltage or if the DC content of the acquired signal is important. Most IEPE input signals require AC coupling.

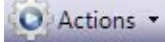
If you want to set the coupling type for all analog input channels at once, select the **multi-channel Actions** button (  ), click **Set all Channel Coupling**, and select either **AC** or **DC**.

---

**Note:** On some devices, such as the DT9839 and DT9839E, AC or DC coupling is determined by the way the input is wired to the device; therefore, this software setting is not available for these devices.

---

### **Current Source**

Enable use of the 4 mA current source by checking the **Current Source** checkbox, or disable use of the 4 mA current source by unchecking the **Current Source** checkbox. Most IEPE input signals require use of the current source.

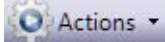
If you want to set the current source for all analog input channels at once, select the **multi-channel Actions** button (  ), click **Set all Channel Current Source**, and select either **Enabled** or **Disabled**.

---

**Note:** On some devices, such as the DT9839 and DT9839E, use of the current source is determined by the way the input is wired to the device; therefore, this software setting is not available for these devices.

---

### **Engineering Unit (EU)**

You can choose from one of the following engineering units to represent the data, based on the sensor that is attached to the channel:

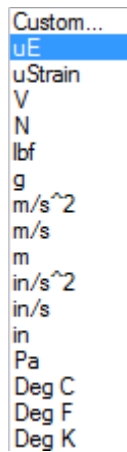

If you select **Custom**, you can define your own engineering units.

If you want to set the engineering units for all analog input channels at once, select the **Multi-channel Actions** button (  Actions ▾ ), click **Set all Channel Units**, and select the desired engineering units.

If you want to set the engineering units for some but not all analog input channels at once, select the **Multi-channel Actions** button (  Actions ▾ ), click **Set all Selected Channel Units**, and select the desired engineering units.

### ***mV/EU***

Depending on the engineering units that you selected, you can enter the number of millivolts per engineering unit (mV/EU) by which to scale the raw voltage.

### ***EU Offset***

Depending on the engineering units that you selected, you can enter an offset (EU Offset) value to add to the scaled signal.

### ***Point #***

If desired, you can enter a number representing the test point to which this channel corresponds. By default, values start at 1 and increment with each channel.

### ***Dir***

Specify one of the following sensor directions for the analog input channel, if desired: X+, X-, Y+, Y-, Z+, Z-, or Scalar (no direction).

## Analog Input Channel Settings for Devices that Support Strain Gages and Bridges

This section describes the settings that you can configure for the analog input channels on devices, such as the DT9838 and DT9829 modules, that support strain gages and bridges.

### ***Enable Shunt Resistor***

For devices that support an internal shunt resistor, you can quickly verify your wiring by enabling the internal shunt resistor and acquiring data from the strain gage or bridge. You can then determine whether the value that you measured is what you expected. (Be sure to disable the shunt resistor after you have verified your wiring.)

Note that this use of the shunt resistor is different from the use of the shunt resistor when performing shunt calibration. Shunt calibration is done using the Configuration and Calibration wizard, described next. During shunt calibration, the software automatically enables the shunt resistor for the calibration procedure and disables it once calibration has been performed.

### ***Configuration and Calibration Wizard***

You can use the **Configuration and Calibration** wizard to set up the parameters for the strain gage or bridge-based sensor and, if desired, calibrate it.

When you click the **Configure and Calibrate** button, a screen similar to the following is displayed:

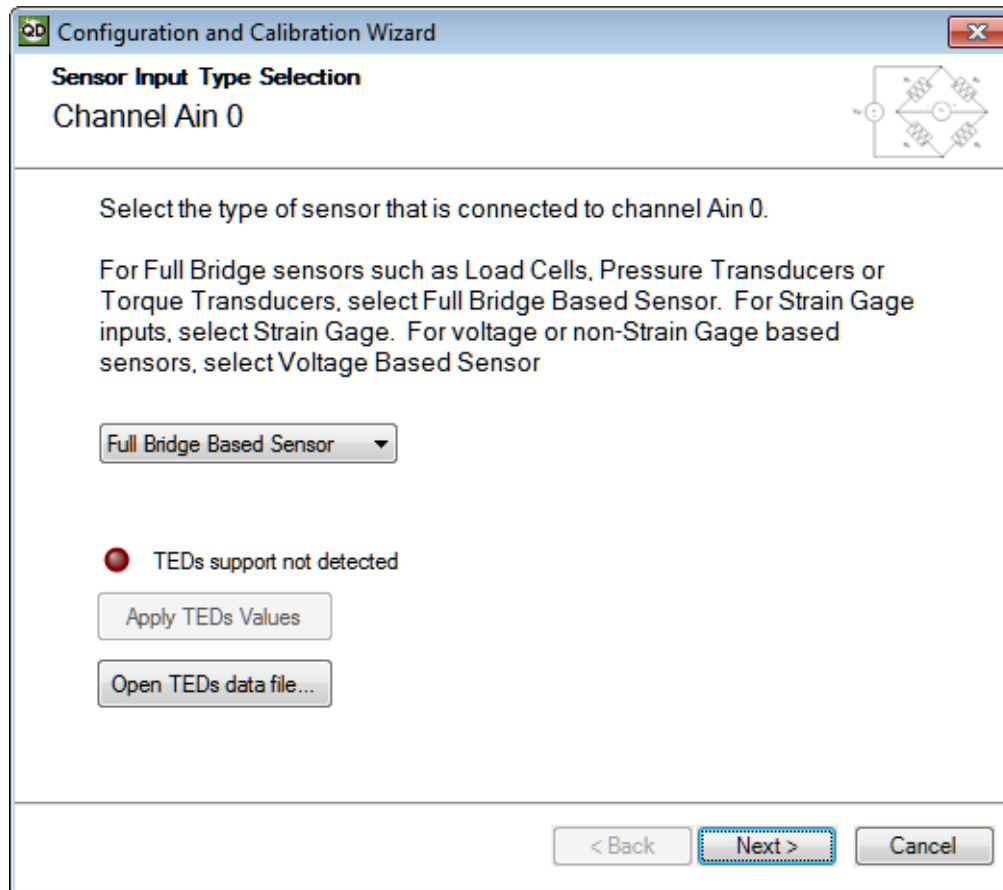

Depending on your device, the following selections may be available:

- **Full Bridge Based Sensor** – for load cells, pressure transducers, torque transducers, and general-purpose bridge-based sensors
- **Strain Gage** – for strain gage sensors
- **Voltage Based Sensor** – for voltage inputs or non-strain gage inputs

If your bridge-based sensor or strain gage supports TEDS (Transducer Electronic Data Sheet) data in hardware, the LED on this screen turns green. Click the **Apply TEDs Values** button to apply the TEDS data to the channel configuration.

If your sensor does not support TEDS data in hardware, the LED on this screen turns red. If a TEDS data file (virtual TEDS) is available for your sensor, click the **Open TEDs data file...** button, select the TEDS data file to read, and click **Open**. The TEDS values are applied to the channel configuration.

Click **Next** to continue to the next page of the wizard.

### Parameters for Full Bridge Based Sensors

If the sensor type is **Full Bridge Based Sensor**, a screen similar to the following appears:

**VF Configuration and Calibration Wizard**  
**Full Bridge Based Sensor Configuration**  
 Channel Ain 0

Transducer Rated Output: 2 mV/V nominal

Transducer Capacity: 1000  $\mu\epsilon$

Using Sense Lines: No

Lead Wire Resistance: 0 Ohms

Excitation Voltage: 5 Volts (all channels)

Nominal Gage: 120 Ohms

Unit:  $\mu\epsilon$

< Back   Next >   Cancel

If you applied TEDS values from the sensor hardware or data file, the TEDS values are displayed in the fields on this screen.



You can configure the following parameters:

- **Transducer Rated Output** – Specify the rated output of the transducer in terms of mV/V excitation.
- **Transducer Capacity** – Specify the full-scale range of the transducer in its native engineering units.
- **Using Sense Lines** – For the selected analog input channel, enter **Yes** if remote sense lines are used or **No** if remote sense lines are not used in the wiring of the strain gage to the device.

The wiring diagram changes depending on this selection. To see the wiring diagram of the strain gage to the device, click the  button.

- **Lead Wire Resistance** – For the selected analog input channel, specify the lead wire resistance, in ohms. Note that if remote sense lines are used, then this value is set to 0 automatically.
- **Excitation Voltage** – Specify the value of the excitation voltage that will be applied to all analog input channels on the device.
- **Nominal Gage** – For the selected analog input channel, enter the nominal gage resistance, in ohms, that is specified by the manufacturer of the sensor.
- **Unit** – For the selected analog input channel, select one of the following engineering units to represent the data, based on the sensor that is attached to the channel:

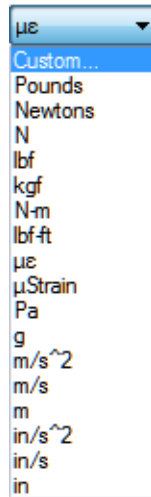

If you select **Custom**, you can define your own engineering units.

Click **Next** to continue to the calibration page of the wizard. A screen similar to the following appears:

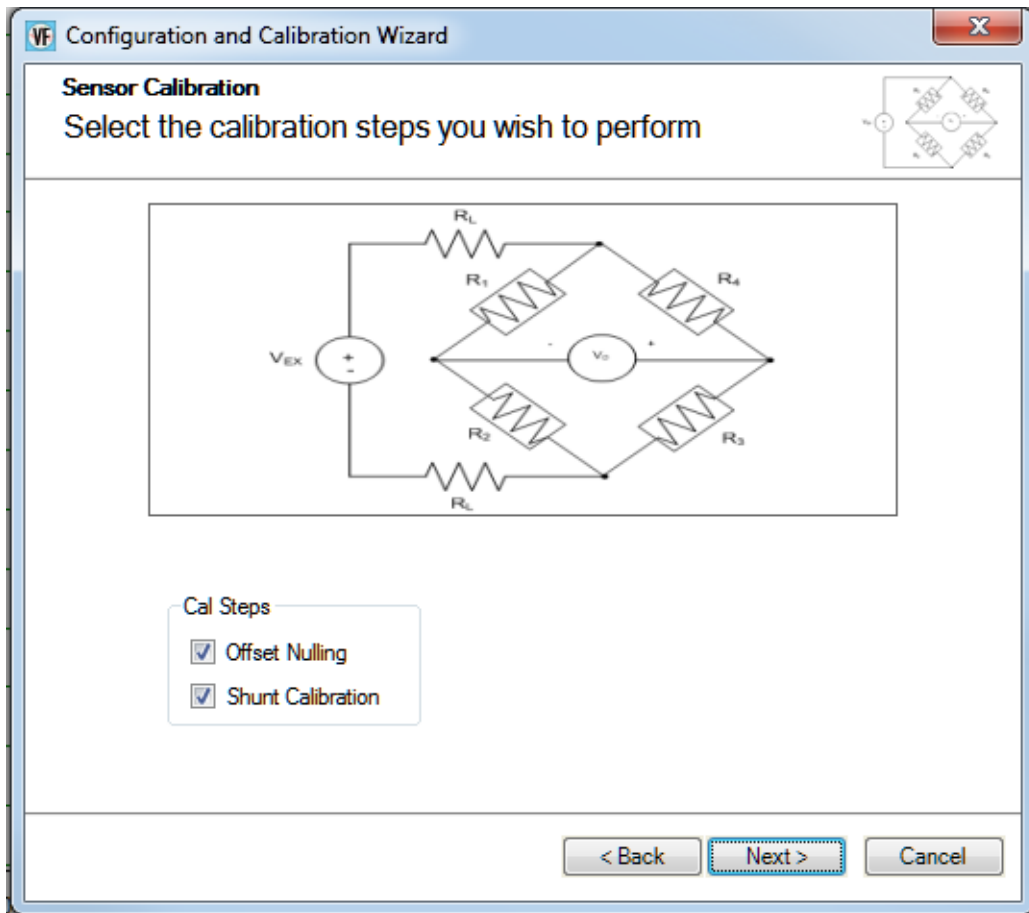

A balanced bridge produces zero volts under ideal conditions with zero strain applied. In practice, however, the output of a bridge in an unstrained condition is offset from zero slightly due to imperfect matching of bridge resistances.

You can adjust the offset of the channel by performing offset nulling on the channel. To perform offset nulling, select the **Offset Nulling** checkbox, click **Next**, and then click **Calibrate**. Internally, this value is subtracted from all subsequent measurements before the voltage is converted to the selected engineering units. Note that you wish, you can reset the value by clicking the **Reset** button.

You can use shunt calibration to correct span errors in the measurement path. To perform shunt calibration, select the **Shunt Calibration** checkbox, and click **Next**. A screen similar to the following appears:

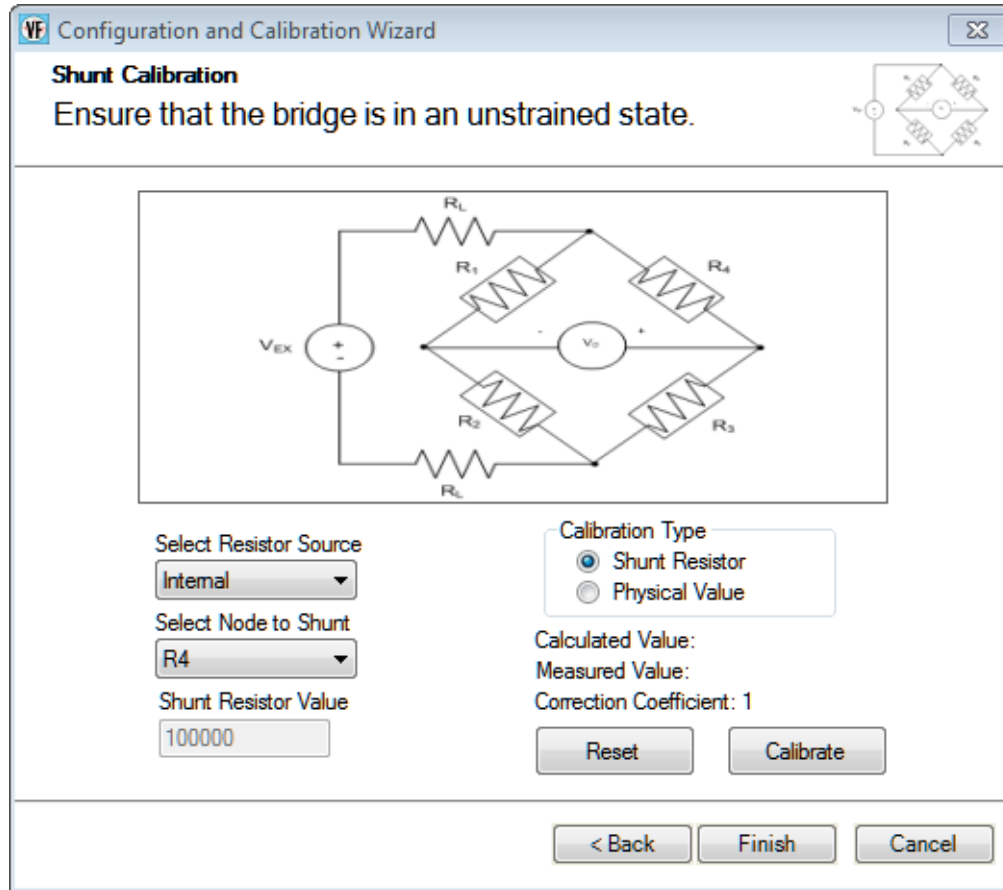

If you want to enter a value rather than use a shunt resistor to perform the shunt calibration procedure, select **Physical Value** as the **Calibration Type**. The page changes to allow you to enter a value. Enter the physical value to apply to the bridge, and click the **Calibrate** button.

If your device supports an internal shunt calibration resistor, you can use this resistor to perform shunt calibration as follows:

1. Select **Shunt Resistor** as the **Calibration Type**.
2. Select **Internal** for the **Select Resistor Source** combo box.
3. Ensure that the internal RSHUNT+ and RSHUNT- lines are connected across the gage and that no strain is applied to the specimen. (The internal shunt resistor is automatically enabled for this procedure and automatically disabled when the shunt calibration procedure is complete.)
4. For the **Select Node to Shunt** combo box, select the node (R1 to R4) that you want to shunt.
5. Click the **Calibrate** button.

If you want to use an external shunt calibration resistor to perform shunt calibration, do the following:

1. Select **Shunt Resistor** as the **Calibration Type**.
2. Select **External** for the **Select Resistor Source** combo box.
3. Ensure that the external shunt resistor is connected across the gage, and that no strain is applied to the specimen.
4. For the **Select Node to Shunt** combo box, select the node (R1 to R4) that you want to shunt.
5. Click the **Calibrate** button.

The calculated value, measured value, and correction coefficient are displayed. Note that you wish, you can reset the values by clicking the **Reset** button.

Click **Finish** when you are done using the wizard.

### Parameters for Strain Gage Sensors

If the sensor type is **Strain Gage**, a screen similar to the following appears:

**VF Configuration and Calibration Wizard**  
**Strain Gage Configuration**  
 Channel Ain 0

Bridge Type: **Quarter Bridge**      Excitation Voltage: **5**      Note: This value will be set for all channels.

**Circuit Diagram:** A quarter bridge circuit with an excitation voltage  $V_{EX}$  connected across nodes R1 and R2. The bridge consists of resistors R1, R2, R3, and R4. A shunt resistor  $R_L$  is connected across R4. The output voltage  $V_o$  is measured across R3.

**Parameters:**

Parameter	Value	Unit
Nominal Gage	120	Ohms
Gage Factor	2	
Using Sense Lines	No	
Lead Wire Resistance	0	Ohms
Min Range	-1000	$\mu\epsilon$
Max Range	1000	$\mu\epsilon$
Unit	$\mu\epsilon$	
Poisson Ratio	0.32	

< Back      Next >      Cancel

If you applied TEDS values from the sensor hardware or data file, the TEDS values are displayed in the fields on this screen.

You can configure the following parameters:

- **Bridge Type** – Select one of the following bridge configurations for each analog input channel; refer to the user’s manual for your device for more information about each of these configuration types:
  - Quarter Bridge
  - Quarter Bridge Temp Comp
  - Full Bridge Axial Poisson
  - Full Bridge Bending
  - Full Bridge Bending Poisson
  - Half Bridge Bending
  - Half Bridge Poisson

A circuit diagram is shown for the selected configuration type. To see how to wire the strain gage to the device, click the  button.

- **Excitation Voltage** – Specify the value of the excitation voltage that will be applied to all analog input channels on the device.
- **Nominal Gage** – For the selected analog input channel, enter the nominal gage resistance, in ohms, that is specified by the manufacturer of the strain gage.
- **Gage Factor** – For the selected analog input channel, enter the gage factor that is specified by the manufacturer of the strain gage.
- **Using Sense Lines** – For the selected analog input channel, enter **Yes** if remote sense lines are used or **No** if remote sense lines are not used in the wiring of the strain gage to the device.

The wiring diagram changes depending on this selection. To see the wiring diagram of the strain gage to the device, click the  button.

- **Lead Wire Resistance** – For the selected analog input channel, specify the lead wire resistance, in ohms. Note that if remote sense lines are used, then this value is set to 0 automatically.
- **Min Range** – For the selected analog input channel, specify the minimum strain value for the range.
- **Max Range** – For the selected analog input channel, specify the maximum strain value for the range.
- **Unit** – For the selected analog input channel, select one of the following engineering units to represent the data, based on the sensor that is attached to the channel:

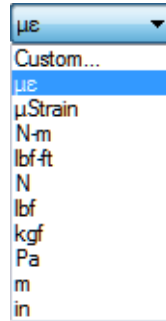

If you select **Custom**, you can define your own engineering units.

- **Poisson Ratio** – Depending on the bridge type, specify the Poisson ratio for each analog input channel. If you click the  button, the following Poisson ratios are displayed for various materials:

Material	Poisson's ratio
rubber	~ 0.50
gold	0.42
saturated clay	0.40-0.50
magnesium	0.35
titanium	0.34
copper	0.33
aluminium-alloy	0.33
clay	0.30-0.45
stainless steel	0.30-0.31
steel	0.27-0.30
cast iron	0.21-0.26
sand	0.20-0.45
concrete	0.20
glass	0.18-0.3
foam	0.10-0.40
cork	~ 0.00

Click **Next** to continue to the calibration page of the wizard. A screen similar to the following appears:

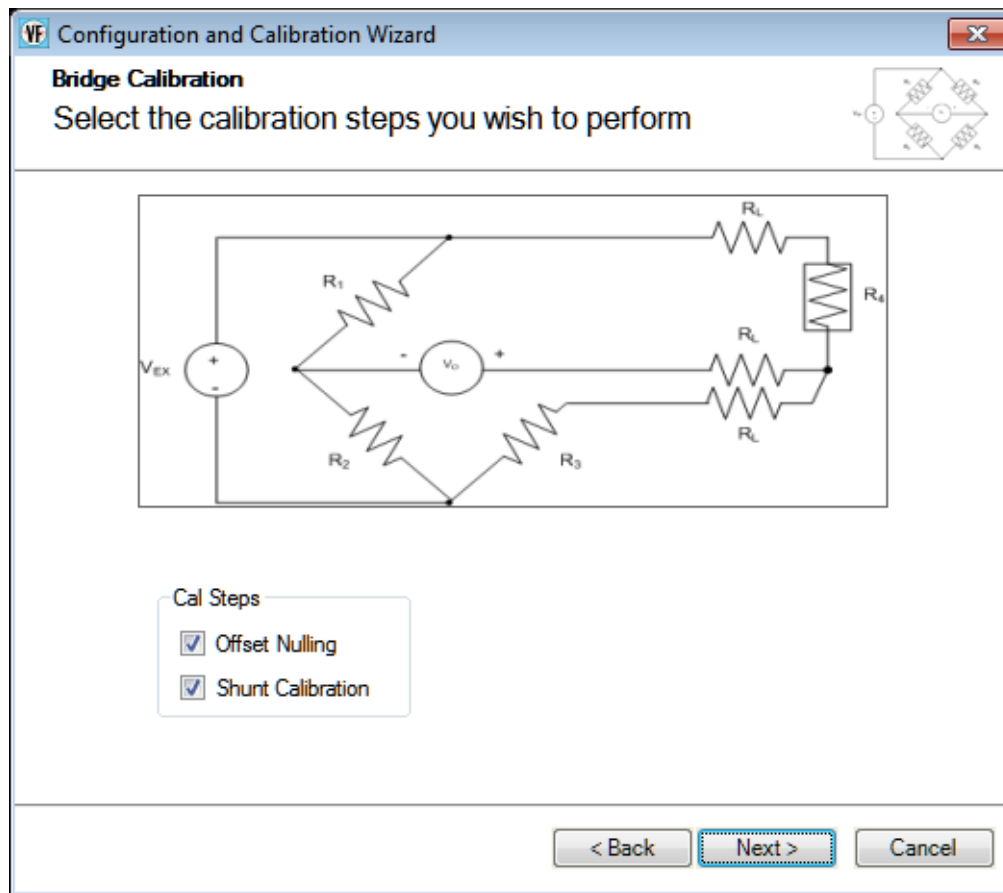

A balanced bridge produces zero volts under ideal conditions with zero strain applied. In practice, however, the output of a bridge in an unstrained condition is offset from zero slightly due to imperfect matching of bridge resistances.

You can adjust the offset of the channel by performing offset nulling on the channel. To perform offset nulling, select the **Offset Nulling** checkbox, and click **Next**. A screen similar to the following appears:

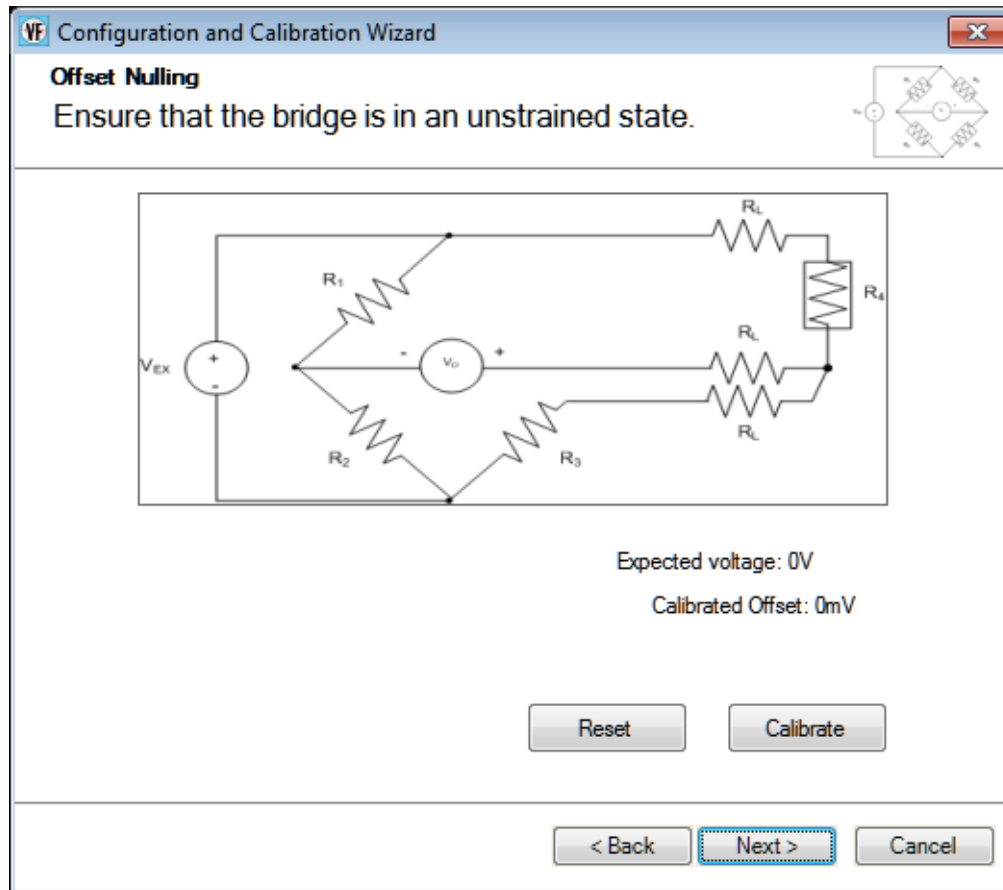

Click **Calibrate**. Internally, the calibrated offset is subtracted from all subsequent measurements before the voltage is converted to strain. Note that you wish, you can reset the value by clicking the **Reset** button.

You can use shunt calibration to correct span errors in the measurement path. To perform shunt calibration, select the **Shunt Calibration** checkbox, and click **Next**. A screen similar to the following appears:



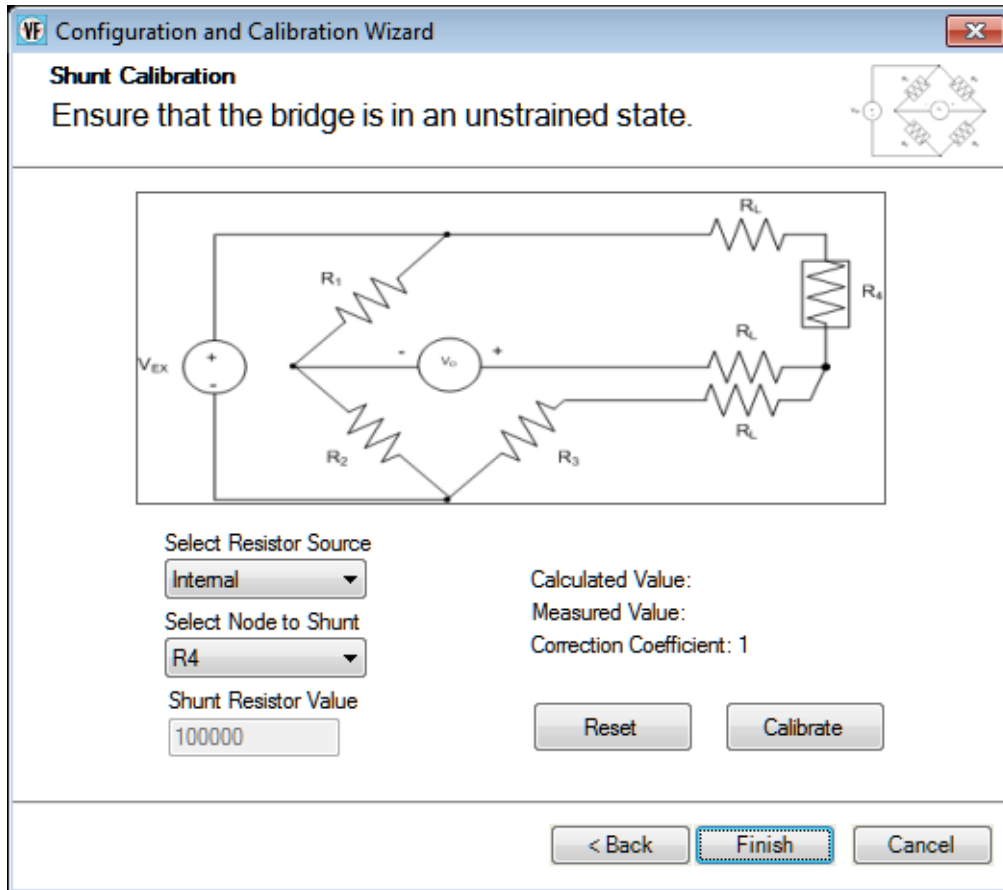

If an internal shunt calibration resistor is provided by the device, you can use the internal shunt resistor to calibrate the strain gage. In this case, select **Internal** in the **Select Resistor Source** combo box, and ensure that the internal RSHUNT+ and RSHUNT– lines are connected across the gage and that no strain is applied to the specimen. (The internal shunt resistor is automatically enabled for this procedure and automatically disabled when the shunt calibration procedure is complete.) Then, for the **Select Node to Shunt** combo box, select the node that you want to shunt (the values depend on the bridge type that you selected).

If you want to use a user-supplied external shunt calibration resistor, select **External** for the **Select Resistor Source** combo box, ensure that the external shunt resistor is connected across the gage, and that no strain is applied to the specimen. Then, for the **Select Node to Shunt** combo box, select the node that you want to shunt (the values depend on the bridge type that you selected).

Once the shunt calibration parameters have been configured, click **Calibrate**. The calculated value, measured value, and correction coefficient are displayed. Note that you wish, you can reset the values by clicking the **Reset** button.

Click **Finish** when you are done using the wizard.

## Parameters for Voltage Based Sensors

If the sensor type is **Voltage Based Sensor**, a screen similar to the following appears:

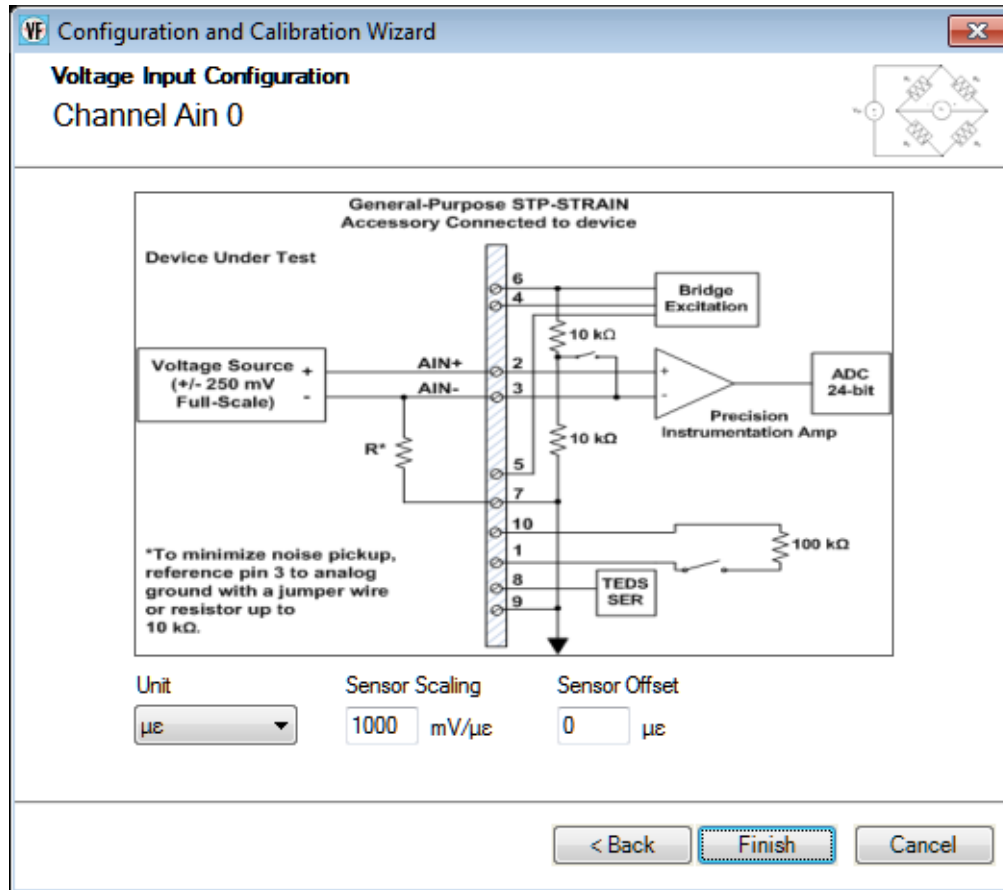

You can configure the following parameters:

- **Unit** – You can choose from one of the following engineering units to represent the data, based on the input that is attached to the channel:

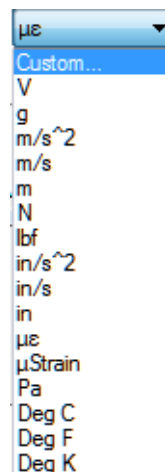

If you select **Custom**, you can define your own engineering units.

- **Sensor Scaling** – Depending on the engineering units that you select, you can enter the number of millivolts per engineering unit (mV/EU) by which to scale the raw voltage.
- **Sensor Offset** – Depending on the engineering units that you select, you can enter an offset value to add to the scaled signal.

Click **Finish** when you are done using the wizard.

### ***Point #***

If desired, you can enter a number representing the test point to which this channel corresponds. By default, values start at 1 and increment with each channel.

## **Digital Input Settings**

If your device supports the ability to report the value of the digital input port in the analog input data stream, enable the digital input (DIN) channel.

The engineering units are automatically set to Bits.

## **Tachometer Settings**

This section describes the settings that you can configure for tachometer channels that are supported in the analog input data stream.

### ***Engineering Unit (EU)***

For each tachometer channel, you can choose from one of the following engineering units to plot the data:

- **RPM** – Choose **RPM** if you want to plot the data from the tachometer in RPMs.
- **Sec** – Choose **Sec** if you want to plot the data from the tachometer in seconds.
- **Hz** – Choose **Hz** if you want to plot the data from the tachometer in Hertz.

### ***Ticks/Rev***

When you select **RPM** as the engineering unit for the tachometer, enter the number of ticks per revolution for your particular tachometer in the **Ticks/Rev** field. This allows the application to calibrate to the characteristics of your tachometer.

### ***Max RPM***

When you select **RPM** as the engineering unit for the tachometer, enter the maximum number of revolutions per minute for your particular tachometer in the **Max RPM** field.

This allows the application to calibrate to the characteristics of your tachometer.

### ***RPM Multiplier***

When you select **RPM** as the engineering unit for the tachometer, you can enter a value in the **RPM Multiplier** field to convert RPM into other units, such as Miles per Hour, Revolutions Per Second, or Hz. For example, to multiply by a factor of 2, enter 2 in the **RPM Multiplier** field. To divide by 2, enter a value of 0.5 in the **RPM Multiplier** field.

### ***Max mSec/Hz***

When you select **Sec** or **Hz** for the engineering units of the tachometer, you can enter the maximum value for the Y-axis in the **Max mSec/Hz** field.

### ***Tach Edge***

On the DT9837, the period of the tachometer input signal is not programmable; it is always measured from rising-to-rising edge. For other devices, select which period of the tachometer input signal to measure:

- **Rising** – Measures from the rising-to-rising edge of the tachometer input signal.
- **Falling** – Measures from the falling-to-falling edge of the tachometer input signal.

---

**Note:** Old tachometer values (from a previous tachometer operation) may be in the data stream until two tachometer edges of the specified type are detected.

---

## Counter Settings

This section describes the settings that you can configure for counters that are supported in the analog input data stream.

Note that counters may be used differently depending on the device. For example, [Table 2](#) describes how the counters are used the DT9837 Series devices. Refer to the documentation for your device for information on the counters provided by your device.

**Table 2: Use of Counter 1 and Counter 2 on Each Device**

Device	Counter 1 (Tach Counter)	Counter 2 (Gate Counter)
<b>DT8837</b>	Measure the frequency, period, or phase between two specified signals.	Measure the frequency, period, or phase between two specified signals.
<b>DT9837</b>	Not supported.	Not supported.
<b>DT9837A</b>	Measures the phase of the tachometer signal.	Not accessible on the device.
<b>DT9837A-OEM</b>	Measures the phase of the tachometer signal.	Measures the pulse width of the gate input signal or the phase between the gate signal and the A/D completion signal.
<b>DT9837B</b>	Measures the phase of the tachometer signal.	Measures the pulse width of the gate input signal or the phase between the gate signal and the A/D completion signal.
<b>DT9837C</b>	Not supported.	Not supported.
<b>DT9838</b>	Measure the frequency or period of the tachometer input signal.	Not supported.

### **Engineering Unit (EU)**

For each counter, you can choose from one of the following engineering units to plot the data:

- **Sec** – Choose Sec if you want to plot the data from the counter in seconds.
- **Hz** – Choose Hz if you want to plot the data from the counter in Hertz.
- **Counts** – Some devices provide the **Counts** option. Choose **Counts** if you want to plot the number of counts that were counted by the counter/timer.

### **Max mSec/Hz**

When you select **Sec** or **Hz** for the engineering units of the counter, you can enter the maximum value for the Y axis in the **Max mSec/Hz** field.

### **Start Edge**

For each supported counter, select the signal edge that will start the measurement. You can choose from the following signals (note that not all options are provided by all devices):

- **A/D Complete**
- **Tach Rising** (on the DT9837 Series, this is supported by the Tach Counter only)
- **Tach Falling** (on the DT9837 Series, this is supported by the Tach Counter only)
- **Clock Rising**
- **Clock Falling**
- **Gate Rising** (on the DT9837 Series, this is supported on the Gate Counter only)
- **Gate Falling** (on the DT9837 Series, this is supported by the Gate Counter only)

### **Stop Edge**

For some devices, you can specify the stop edge of the counter, which stops the measurement. You can choose from the following signals:

- **A/D Complete**
- **Tach Rising** (on the DT9837 Series, this is supported by the Tach Counter only)
- **Tach Falling** (on the DT9837 Series, this is supported by the Tach Counter only)
- **Gate Rising** (on the DT9837 Series, this is supported on the Gate Counter only)
- **Gate Falling** (on the DT9837 Series, this is supported by the Gate Counter only)

## Quadrature Decoder Channel Settings

This section describes the settings that you can configure for quadrature decoder channels that are supported in the analog input data stream.

### **Engineering Unit (EU)**

For each counter, you can choose from one of the following engineering units to plot the data:

- **Deg** – Choose **Deg** if you want to plot the data from the quadrature decoder in degrees.
- **Counts** – Choose **Counts** if you want to plot the number of counts that were counted by the quadrature decoder.

### **Pulses/Rev**

Enter the number of pulses per revolution for your quadrature encoder. This number is device-specific; therefore, refer to the documentation for your quadrature encoder to determine this number.

### **Clock Prescale**

Enter the pre-scale value that is used to filter the onboard clock. Using a clock pre-scale value can remove ringing edges and unwanted noise for more accurate data.

### **X4 Scaling**

The scaling mode (X1 or X4 mode), determines the resolution of the quadrature encoder. If X4 Scaling is disabled, X1 mode is used. In X1 mode, the quadrature decoder counts the edges on the A signal input.

If X4 scaling mode is enabled, X4 scaling mode is used. In X4 mode, the quadrature decoder counts the edges on the A and B signal inputs. Therefore, if a quadrature encoder has 360 pulses per revolution, X1 mode yields 360 counts when the quadrature encoder is rotated 360 degrees. X4 mode yields four times the number of counts, or 1440 (360 x 4) when the quadrature encoder is rotated 360 degrees.

### **Index Mode**

You can specify one of the following for the **Index Mode**:

- **High** – The Index input is enabled and the positional count is zeroed on the high edge of the Index signal.
- **Low** – The Index input is enabled and the positional count is zeroed on the low edge of the Index signal.
- **Disabled** – The Index input is disabled and the positional count is not zeroed. Note that if **X4 Scaling** is Enabled, **Index Mode** must be disabled.

## Applying and Saving Changes

Click **Close** when you are through with this dialog box to apply the changes you made to the hardware and to reconfigure the application, as needed.

For information on saving and loading a configuration file, refer to [page 44](#). For information about the backup configuration file, refer to [page 45](#).



## Configuring the Settings of the Recording Tab

Before starting acquisition, configure how the data is recorded using the Recording tab of the Acquisition Config window.



The Recording tab is different depending on the interface mode you are using, as described below.

### Recording Tab When Using the Data Logger Interface

If you are using the Data Logger interface, the Recording tab appears as follows:

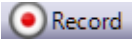
The Recording tab of the Data Logger interface contains these settings:

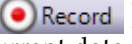
- **Filename generation** – Specify how to create the name of the file. You can choose one of the following options:
  - **Filename** – The specified filename is created when you click the **Record** toolbar button (  ). Each time you click the **Record** toolbar button, you will be prompted to overwrite the file. QuickDAQ Data.hpf is an example of a filename that was created using the Filename option.

- **Filename-Sequence** – The specified filename is created and a starting number that you define is appended to the filename when you click the **Record** toolbar button (  ). Each time you click the **Record** toolbar button, the number that is appended to the filename is incremented by one. QuickDAQ Data-1.hpf is an example of a filename that was created using the Filename-Sequence option.
- **Filename-DateTime** – The specified filename is created and the current date and time is appended to the filename when you click the **Record** toolbar button (  ). Each time you click the **Record** toolbar button, the filename with the current date and time is created. QuickDAQ Data-2012-11-15\_02-15-31-PM.hpf is an example of a filename that was created using the Filename-DateTime option.
- **Filename base** – Specify the name of the High Performance binary file (.hpf) in which to store the data that is recorded when you click the **Record** toolbar button (  ). The default path is shown. You can change this path, if desired. The application saves the data file path and is uses this path by default.
- **Enable Continuous Acquisition** – Determines how data acquisition and processing stops.

Check this checkbox to enable continuous acquisition. In this mode, you must click the **Stop** button or hold down the **Shift** key and press the **F5** key to stop acquisition/processing.

If the **Enable Continuous Acquisition** checkbox is unchecked, you must specify how long to acquire data using the Acquisition Duration.

---

**Note:** Continuous acquisition is supported by DT8824, DT8837, and MEASURpoint devices when using the Data Logger interface.

If a device is acquiring data continuously and unread data in the hardware circular memory buffer starts to be overwritten, acquisition is stopped and an overrun error is reported.

---

- **Acquisition Duration** – (Available only if the **Enable Continuous Acquisition** checkbox is unchecked). You can either enter a value that specifies the number of days (dd), number of hours (hh), minutes (mm), and seconds (ss) that you want to acquire data from the device, or select one of the following predefined values from the combo box:
  - 10 Seconds
  - 1 Minute
  - 5 Minutes
  - 10 Minutes
  - 30 Minutes
  - 1 Hour
  - 5 Hours
  - 12 Hours
  - 1 Day
  - 2 Days

If the **Enable Continuous Acquisition** checkbox is unchecked, acquisition stops automatically when the specified duration elapses.

- **X Axis Span** – You can either enter a value that specifies the number of days (dd), number of hours (hh), minutes (mm), and seconds (ss) that you want to use for the span of the x-axis of the plots on the Channel Plot window, or select the default value from the combo box.

---

**Note:** If you specify a value for the x-axis span that is less than the acquisition duration, the x-axis scrolls using the span you specified.

---

- **Notes** – Use this field to add any notes as desired. If you choose to export the data to ASCII, this information is also exported.

Based on the information that you enter for the **Recording** tab and the **Acquisition** tab (for the Data Logger interface), or **Freq** tab (for the FFT Analyzer interface), the software configures the hardware and displays the following configuration settings used by the device:

- The actual sample rate used by the device.
- The actual sample interval used by the device.
- The actual number of scans to acquire.

## Recording Tab When Using the FFT Analyzer Interface

If you are using the FFT Analyzer interface, the Recording tab appears as follows:

The screenshot shows the 'Recording' tab of the FFT Analyzer interface. It features a tabbed menu at the top with 'Recording', 'Freq', 'Trigger', 'Window', and 'Output'. The 'Recording' tab is active. Below the menu, the 'Data File' section includes 'Filename generation' with a dropdown set to 'Filename-Sequence' and a 'Start #' field set to '1'. The 'Filename Base' is 'QuickDAQ Data' with a file extension of '.hpf' and a browse button. The full file path is displayed as 'C:\Users\Nletoumeau\AppData\Local\Data Translation\QuickDAQ\Data\QuickDAQ Data-2.hpf'. A note indicates '173 GB disk space available'. The 'Duration' section has an unchecked checkbox for 'Enable Continuous Acquisition', a 'Number of Averages' field set to '50', and a 'Run length: 12.8 Sec' field. The 'X Axis Span (Time domain)' is set to '00:00:00:12' with a dropdown arrow and the label 'dd.hh.mm:ss', and an unchecked checkbox for 'Same as run length'. A instruction reads 'Click Record button to start recording data to disk.' Below this is a 'Notes' section with an empty text box. At the bottom, the 'Acquisition info' section lists: 'Sample rate: 4000 Hz', 'Sample interval: .00025 Sec', 'Number of scans: 51200', and 'Number of Averages: 50'.

Recording | Freq | Trigger | Window | Output

**Data File**

**Filename generation**  
Filename-Sequence Start # 1

**Filename Base**  
QuickDAQ Data .hpf ...

C:\Users\Nletoumeau\AppData\Local\Data Translation\QuickDAQ\Data\QuickDAQ Data-2.hpf

173 GB disk space available

**Duration**

Enable Continuous Acquisition

**Number of Averages**  
50

Run length: 12.8 Sec

**X Axis Span (Time domain)**  
00:00:00:12 dd.hh.mm:ss





Same as run length

Click Record button to start recording data to disk.

**Notes**

Acquisition info  
Sample rate: 4000 Hz  
Sample interval: .00025 Sec  
Number of scans: 51200  
Number of Averages: 50

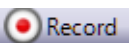
The Recording tab of the FFT Analyzer interface contains these settings:

- **Filename generation** – Specify how to create the name of the file. You can choose one of the following options:
  - **Filename** – The specified filename is created when you click the **Record** toolbar button (  ). Each time you click the **Record** toolbar button, you will be prompted to overwrite the file. QuickDAQ Data.hpf is an example of a filename that was created using the Filename option.
  - **Filename-Sequence** – The specified filename is created and a starting number that you define is appended to the filename when you click the **Record** toolbar button (  ). Each time you click the **Record** toolbar button, the number that is appended to the filename is incremented by one. QuickDAQ Data-1.hpf is an example of a filename that was created using the Filename-Sequence option.
  - **Filename-DateTime** – The specified filename is created and the current date and time is appended to the filename when you click the **Record** toolbar button (  ). Each time you click the **Record** toolbar button, the filename with the current date and time is created. QuickDAQ Data-2012-06-25\_02-39-59-PM.hpf is an example of a filename that was created using the Filename-DateTime option.
- **Filename base**– Specify the name of the High Performance binary file (.hpf) in which to store the data that is recorded when you click the **Record** toolbar button (  ). The default path is shown. You can change this path, if desired. The application saves the data file path and is uses this path by default.
- **Enable Continuous Acquisition** – Determines how data acquisition and processing stops. Check this checkbox (available on USB modules only) to enable continuous acquisition. In this mode, you must click the **Stop** button or hold down the **Shift** key and press the **F5** key to stop acquisition/processing.  
If the **Enable Continuous Acquisition** checkbox is unchecked, specify the number of averages that the application will compute before stopping acquisition/processing.

---

**Note:** When using the FFT Analyzer interface, continuous acquisition is not supported by DT8824 and DT8837 devices due to FFT data block size requirements and the possibility of network traffic preventing continuous streaming. Continuous acquisition is supported by MEASURpoint devices, however, due to their slow sampling rates.

If you need continuous acquisition on a DT8824 or DT8837 device, use the Data Logger interface.

If a device is acquiring data continuously and unread data in the hardware circular memory buffer starts to be overwritten, acquisition is stopped and an overrun error is reported.

---

- **Number of Averages** – (Available only if the **Enable Continuous Acquisition** checkbox is unchecked). Specify the number of records to acquire, process, and average.

When the **Enable Continuous Acquisition** checkbox is unchecked, acquisition stops automatically when the specified number of averages has been reached. The software displays the total length of time (the run length) for the specified number of records to be acquired, processed, and averaged), in seconds.

How acquisition starts depends on the trigger settings, described on [page 133](#).

- **X Axis Span** – You can either enter a value that specifies the number of days (dd), number of hours (hh), minutes (mm), and seconds (ss) that you want to use for the span of the x-axis of the plots for the time-domain data on the Channel Plot window, or select the default value from the combo box.

If you want the span of the x-axis to be the same as the run length (the total length of time it takes for the specified number of records to be acquired, processed, and averaged), check the **Same as run length** checkbox.

---

**Note:** If you specify a value for the x-axis span that is less than the acquisition duration, the x-axis scrolls using the span you specified.

---

- **Notes** – Use this field to add any notes as desired. If you choose to export the data to ASCII, this information is also exported.

Based on the settings of the Acquisition Config window, the available disk space is displayed and is updated as the recording progresses.

## Configuring the Settings of the Acquisition Tab (Data Logger Interface Only)

If you are using the Data Logger interface, use the **Acquisition** tab of the Acquisition Config window to set up parameters that apply to the A/D subsystem of the device, including the sampling frequency, trigger source, filter type, temperature units, channel configuration, and/or input voltage range.

The screenshot shows the 'Acquisition' tab of the 'Acquisition Config' window. The 'Recording' tab is selected. The 'Per Channel Sampling Frequency' is set to 195.313 Hz. The 'Trigger Source' is set to 'Analog Threshold Pos Edge'. The 'Threshold Trigger Options' section shows a 'Threshold value' of 2.5 V and a 'Channel' of 'DT9837-C(00).Ain 0'. The 'Single Ended/Differential' option is set to 'SingleEnded'. The 'Input Voltage Range' is set to '-10V to 10V'.

### Sampling Frequency

Enter the sampling frequency per channel for the device. For simultaneous devices, the total throughput is the same as the per channel sampling frequency, since all channels are acquired at the same time.

For multiplexed devices, multiply the per channel sampling frequency by the number of enabled channels to determine the total throughput. For example, if five analog input channels are enabled on the multiplexed device and the per channel sampling frequency is 200 Hz, the total throughput is 1000 Hz (200 Hz x 5).

Refer to the user's manual for your device for information on the supported sampling frequencies.

## Trigger Source

Specify the trigger source that starts acquisition on the device. Examples of trigger sources that may be supported for starting acquisition on the device include the following:

- **Software** – The device starts acquiring scans when you click the **Record** button or press the **F5** key. Once acquisition starts, all triggers are ignored. Acquisition stops when the conditions defined in the **Recording** tab, described on [page 121](#), are met.
- **External TTL Pos Edge** – The device starts acquisition when it detects a rising-edge voltage on the external trigger line. Once triggered, the state of external trigger line is ignored. The process continues until the conditions defined in the **Recording** tab, described on [page 121](#), are met.
- **External TTL Neg Edge** – The device starts acquisition when it detects a negative-edge voltage on the external trigger line. Once triggered, the state of external trigger line is ignored. The process continues until the conditions defined in the **Recording** tab, described on [page 121](#), are met.
- **Analog Threshold Pos Edge** – The device starts acquisition when it detects a positive edge, analog threshold trigger event. You can specify the threshold value on which to trigger and the channel to use for the analog threshold trigger.

You cannot use this trigger source if the following condition are true on the Output tab: the analog output channel is enabled and the start method is On Acquisition Start.

- **Analog Threshold Neg Edge** – The device starts acquisition when it detects a negative edge, analog threshold trigger event. You can specify the threshold value on which to trigger and the channel to use for the analog threshold trigger.

You cannot use this trigger source if the following condition are true on the Output tab: the analog output channel is enabled and the start method is On Acquisition Start.

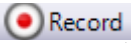
For example, assume that you specified the trigger source as **External TTL Pos Edge**, set the **Acquisition Duration** field on the **Recording** tab to **5 Seconds**, and clicked the **Record** toolbar button (  ) or pressed the **F5** key. In this example, the device waits until it detects a rising-edge TTL pulse on external trigger line before acquiring data. When five seconds of data are acquired, acquisition stops.

Refer to the user's manual for your device for information on the supported trigger sources.

## Filter Type

If supported by your device, you can configure one of the following filter types:

- **Moving average** – (The default filter setting.) This filter type removes unwanted noise from your measurements and provides a compromise of filter functionality and response time. This filter can be used in any application.

This low-pass filter takes the previous 16 samples, adds them together, and divides by 16.

- **None** – No filter. Provides fast response times, but the data may be difficult to interpret. Use when you want to filter the data yourself.



The data is represented exactly as is when it comes out of the Delta-Sigma A/D converters. Note that Delta-Sigma converters provide substantial digital filtering above the Nyquist frequency.

Generally, the only time it is desirable to use the **None** filter setting is if you are using fast responding thermocouples, sampling them at higher speeds (> 1 Hz), and need as much response speed as possible.

## Temperature Units

For thermocouple, RTD, and thermistor measurements, you can select the temperature units (Celsius, Fahrenheit, and Kelvin) into which the voltage data is converted. This setting is applied to all the temperature channels of the device.

You can see which temperature unit will be displayed for each channel in the Configure Devices dialog box, described on [page 92](#).

## Single-Ended or Differential Channel Configuration

If your device supports it, you can select the following channel configuration for the A/D subsystem:

- **Single-ended** – Choose this configuration when you want to measure high-level signals, noise is not significant, the source of the input is close to the device, and all the input signals are referred to the same common ground. Refer to the user's manual for your device for wiring information. Refer to the user's manual for your device for wiring information.
- **Differential** – Choose this configuration when you want to measure thermocouple or low-level signals, you are using an A/D converter with high resolution, noise is a significant part of the signal, or common-mode voltage exists. Refer to the user's manual for your device for wiring information. Refer to the user's manual for your device for wiring information.

## Input Voltage Range

If your device supports multiple input ranges per channel, you configure the input range using the **Configure Devices** dialog, described on [page 90](#).

If your device supports multiple input voltage ranges and/or gains that apply to the entire subsystem, you can select which effective input range to use for the A/D subsystem using the **Input Voltage Range** drop-down box. For example, if your device supports an input range of  $\pm 10$  V with gains of 1 and 2, two effective input ranges are supported:  $\pm 10$  V ( $\pm 10$  V divided by a gain of 1) and  $\pm 5$  V ( $\pm 10$  V divided by a gain of 2).

Refer to the user's manual for your device for specific information on the input voltage ranges and gains that are supported.

## Configuring the Settings of the Freq Tab (FFT Analyzer Interface Only)

If you are using the FFT Analyzer interface, configure the settings of the **Freq** tab of the Acquisition Config window before starting acquisition; these settings are used to program the data acquisition device:

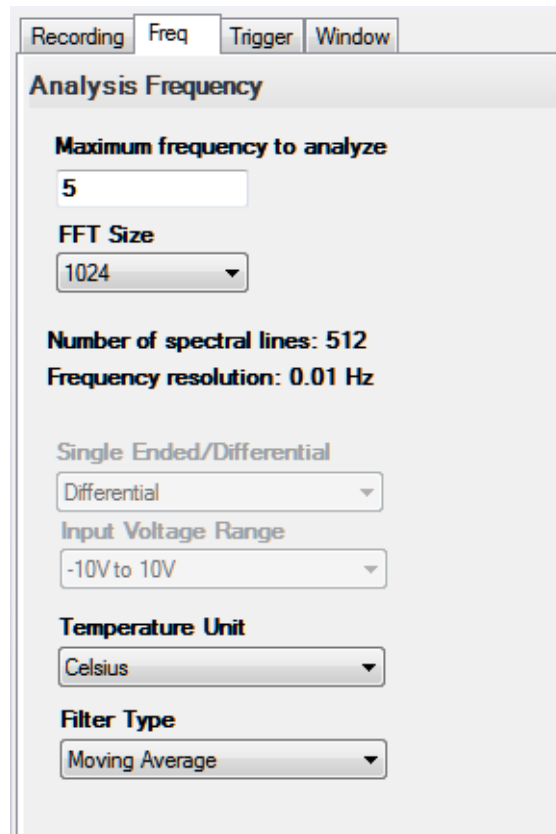

The screenshot shows the 'Freq' tab of the Acquisition Config window. The 'Analysis Frequency' section includes the following settings:

- Maximum frequency to analyze:** 5
- FFT Size:** 1024
- Number of spectral lines:** 512
- Frequency resolution:** 0.01 Hz
- Single Ended/Differential:** Differential
- Input Voltage Range:** -10V to 10V
- Temperature Unit:** Celsius
- Filter Type:** Moving Average

The settings of the **Freq** tab are described in the following subsections. Based on the information that you enter for the **Recording** tab and the **Freq** tab, the software configures the hardware and displays the following configuration settings used by the device:

- The actual sample rate used by the device.
- The actual sample interval used by the device.
- The actual number of scans to acquire.
- The actual number of averages to perform.

### Maximum Frequency to Analyze

Specify the bandwidth or span of the input signals that you want to analyze. Internally, the software multiplies this value by 2 to set the sampling rate of the device.

## FFT Size

Specify how many data points to use when generating the FFTs for the analog input channels.

The number of spectral lines and the frequency resolution are calculated and displayed when the maximum frequency to analyze and the FFT size are changed.

## Single-Ended or Differential Channel Configuration

If your device supports it, you can select the following channel configuration for the A/D subsystem:

- **Single-ended** – Choose this configuration when you want to measure high-level signals, noise is not significant, the source of the input is close to the device, and all the input signals are referred to the same common ground.
- **Differential** – Choose this configuration when you want to measure thermocouple or low-level signals, you are using an A/D converter with high resolution, noise is a significant part of the signal, or common-mode voltage exists.

## Input Voltage Range

If your device supports multiple input ranges per channel, you configure the input range using the **Configure Devices** dialog, described on [page 90](#).

If your device supports multiple input voltage ranges and/or gains that apply to the entire subsystem, you can select which effective input range to use for the A/D subsystem using the **Input Voltage Range** drop-down box. For example, if your device supports an input range of  $\pm 10$  V with gains of 1 and 2, two effective input ranges are supported:  $\pm 10$  V ( $\pm 10$  V divided by a gain of 1) and  $\pm 5$  V ( $\pm 10$  V divided by a gain of 2).

Refer to the user's manual for your device for specific information on the input voltage ranges and gains that are supported.

## Temperature Units

For thermocouple, RTD, and thermistor measurements, you can select the temperature units (Celsius, Fahrenheit, and Kelvin) into which the voltage data is converted. This setting is applied to all the temperature channels of the device.

You can see which temperature unit will be displayed for each channel in the **Configure Devices** dialog box, described on [page 92](#).

## Filter Type

If supported by your device, you can configure one of the following filter types:

- **Moving average** – (The default filter setting.) This filter type removes unwanted noise from your measurements and provides a compromise of filter functionality and response time. This filter can be used in any application.

This low-pass filter takes the previous 16 samples, adds them together, and divides by 16.

- **None** – No filter. Provides fast response times, but the data may be difficult to interpret. Use when you want to filter the data yourself.

The data is represented exactly as is when it comes out of the Delta-Sigma A/D converters. Note that Delta-Sigma converters provide substantial digital filtering above the Nyquist frequency.

Generally, the only time it is desirable to use the **None** filter setting is if you are using fast responding thermocouples, sampling them at higher speeds (> 1 Hz), and need as much response speed as possible.

## Configuring the Settings of the Trigger Tab (FFT Analyzer Interface Only)

If you are using the FFT Analyzer interface, use the **Trigger** tab of the Acquisition Config window to set up the trigger source that starts acquisition on the device and the trigger mode.

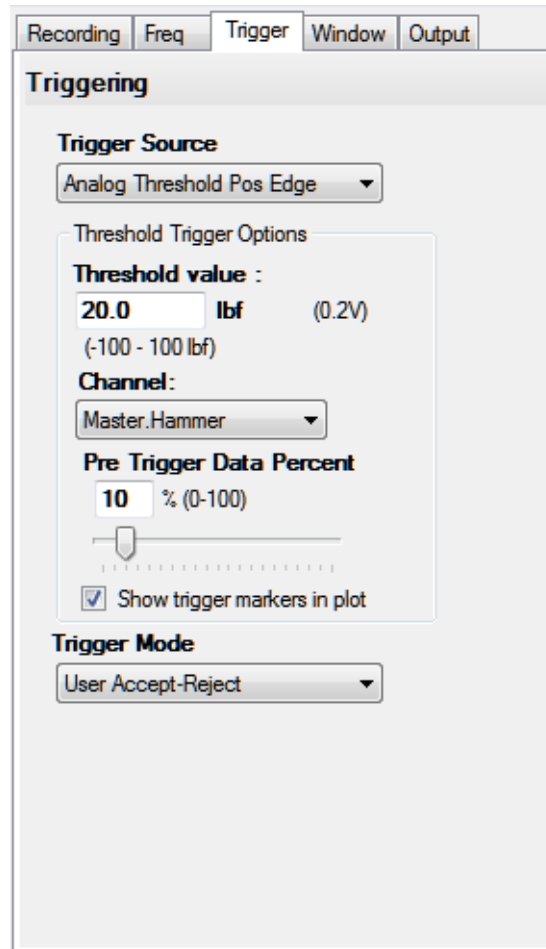

## Trigger Source

The following trigger sources are supported for starting acquisition on the device:

---

**Note:** In multiple device configurations, the trigger source is the trigger that starts acquisition on the master device.

---

- **Free Run** – The device starts acquiring contiguous, gap-free, records when you click the **Record** button or press the **F5** key.

If the **Enable Continuous Acquisition** checkbox on the **Recording** tab, described on [page 121](#), is checked, you must click the **Stop** button or hold down the **Shift** key and press the **F5** key to stop acquisition/processing.

If the **Enable Continuous Acquisition** checkbox on the **Recording** tab is unchecked, acquisition stops automatically when the specified number of records have been averaged.

- **External TTL Pos Edge** – The device acquires one record each time it detects a rising-edge transition on the external digital (TTL) signal connected to the Trigger In input. The process continues until the conditions defined in the **Recording** tab, described on [page 121](#), are met.

This trigger provides a threshold voltage of 2 V with 0.5 V of hysteresis.

- **Analog Threshold Pos Edge** – The device acquires one record each time it detects a positive edge, analog threshold trigger event. Refer to [page 135](#) or the threshold trigger options.

You cannot use this trigger source if the following condition are true on the Output tab: the analog output channel is enabled and the start method is On Acquisition Start.

- **Analog Threshold Neg Edge** – The device acquires one record each time it detects a negative edge, analog threshold trigger event. Refer to [page 135](#) or the threshold trigger options.

You cannot use this trigger source if the following condition are true on the Output tab: the analog output channel is enabled and the start method is On Acquisition Start.

- **LXI0 to LXI5** – Supported on DT8837 devices only, the device acquires one record each time it detects the specified LXI trigger on the Trigger Bus. (This trigger source applies to the master device only.)
- **LAN0 to LAN7** – Supported on DT8837 devices only, the device acquires one record each time it detects the specified LAN trigger event.
- **Software Triggered** – The device starts acquiring records based on an internal software trigger. If Auto Retrigger as the trigger mode, you can also specify a delay, in seconds, to wait before the next software triggered record/frame is acquired. By default, the delay is 0 s, which is equivalent to no delay. Refer to [page 136](#) for more information on Auto Retrigger mode.

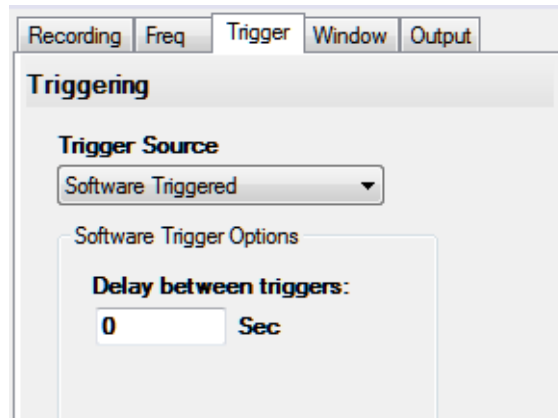

This mode is typically used in conjunction with the **Output** tab when you want to use an analog output signal to generate burst random and burst chirp operations; in these applications, the full output frequency range and duration is contained within the time of a single analysis frame or record.

---

**Note:** When you use the software triggered option, the horizontal axis of the Channel Plot shows relative time within the average, not absolute time, as some overhead is required to start each acquisition when the trigger occurs.

---

If the **Enable Continuous Acquisition** checkbox on the **Recording** tab, described on [page 124](#), is checked, you must click the **Stop** button or hold down the **Shift** key and press the **F5** key to stop acquisition/processing.

If the **Enable Continuous Acquisition** checkbox on the **Recording** tab is unchecked, acquisition stops automatically when the specified number of records have been averaged.

## Threshold Trigger Options

If you selected the analog threshold trigger as the trigger source, the following options are available for configuring the threshold trigger:

- **Threshold Value** – Enter the user-specified threshold value in the units of the threshold channel that you select. (QuickDAQ supports a threshold voltage between 0.8 V and 9.8 V for the DT8837, and –9.8 V to +9.8 V for the DT9837 Series modules.)
- **Channel** – Specify the channel to use for the analog threshold trigger. For the DT8837, this is analog input channel 0. For the DT9837 Series modules, this can be any enabled analog input channel.

- **Pre Trigger Data Percent** – Specify the percentage of data (0 to 100) that you want to acquire prior to the start of the threshold trigger event. This allows you to acquire the entire pulse and get a reliable trigger. If you specify 0% as the pre-trigger data, only the data after the trigger is captured.

Note that an entire record of data is always captured when the threshold trigger event occurs; however, the percentage of pre-trigger data that you requested is not guaranteed, as the trigger event may occur earlier than expected.

- **Show trigger markers in plot** – Select this checkbox if you want to see when the trigger occurred in the trace for the stimulus (reference) signal. The trigger marker is shown in red if you do not get all the pre-trigger data that you specified. If you get all the pre-trigger data that you specified, the trigger marker is displayed in the same color as the trace color.

---

**Note:** Ensure that the trace color is not red if you want to use the color of trigger marker to indicate whether or not you captured all the pre-trigger data.

---

## Trigger Mode

If the trigger source is not **Free Run**, you can specify how you want to accept each average by choosing one of the following trigger modes:

- **Auto Retrigger** – Select this trigger mode if you want the application to accept the data after each average automatically.
- **User Accept-Reject** – Select this trigger mode if you want to determine whether to keep the data after each average.

Once you start recording when using this trigger mode, you must click the **Accept** button (to keep the data) or click the **Reject** button (if you do not want to keep the data) after each average. The **Accept** and **Reject** buttons are located in the Acquisition Status window under the Channel Plot and Channel Display windows.

---

**Note:** Once a record has been acquired and the software is waiting for you to click the **Accept** or **Reject** button, the Channel Plot window controls are enabled. This allows you to review the data in detail before you accept or reject it.

To start the next average, ensure that you provide the appropriate trigger.

---



## Configuring the Settings of the Window Tab (FFT Analyzer Interface Only)

If you are using the FFT Analyzer interface, specify the windowing function to apply to the FFT channels to reduce spectral leakage errors using the **Window** tab of the Acquisition Config window. The contents of the Window tab are different for the FFT Analysis and Advanced FFT Analysis options.

### Window Tab for the FFT Analysis Option

If you are using the FFT Analysis option, the Window tab appears as follows:

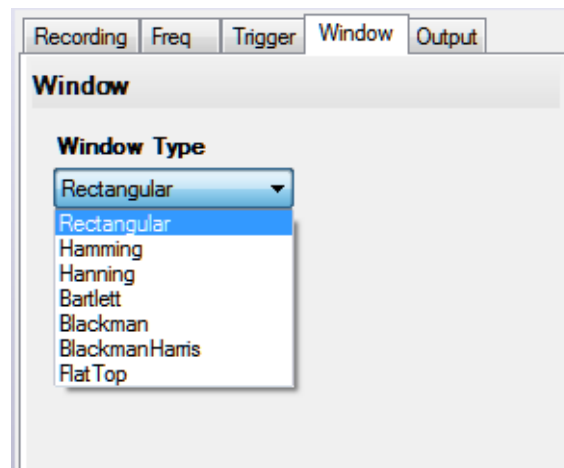

The following windowing types are available when generating FFTs; this is a global setting that is applied to all FFT channels:

- **Rectangular** – No window. Recommended for use when your signal content contains random noise (white noise) or closely spaced sine waves.
- **Hamming** – Bell-shaped cosine window optimized to minimize the maximum (nearest) side lobe. Recommended for use when your signal content consists of closely spaced sine waves.
- **Hanning** – Bell-shaped cosine window typically used to analyze continuous signals. Recommended for use when your signal content contains sine waves, a combination of sine waves, vibration data consisting of narrowband random signals, or unknown content.
- **Bartlett** – Triangular window.
- **Blackman** – Similar to the Hanning and Hamming windows, this window has slightly wider central lobes and less sideband leakage.
- **BlackmanHarris** – Similar to Hanning window, this window has a slightly wider main lobe but much better dynamic range. It is optimized to provide the minimum side lobe level.

- **FlatTop** – Optimized for measuring peak amplitudes of discrete spectral components that are separated by several spectral lines. Recommended for use when your signal content consists of sine waves and amplitude accuracy is important.

## Window Tab for the Advanced FFT Analysis Option

If you are using the Advanced FFT Analysis option, the Window tab appears as follows:

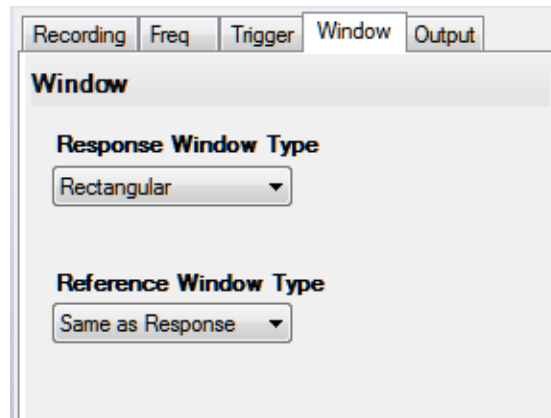

The following windowing types are available when generating FFTs for channels that were configured as response channels; this is a global setting that is applied to the FFTs of all enabled response channels:

- **Rectangular** – No window. Recommended for use when your signal content contains random noise (white noise) or closely spaced sine waves.
- **Hamming** – Bell-shaped cosine window optimized to minimize the maximum (nearest) side lobe. Recommended for use when your signal content consists of closely spaced sine waves.
- **Hanning** – Bell-shaped cosine window typically used to analyze continuous signals. Recommended for use when your signal content contains sine waves, a combination of sine waves, vibration data consisting of narrowband random signals, or unknown content.
- **Bartlett** – Triangular window.
- **Blackman** – Similar to the Hanning and Hamming windows, this window has slightly wider central lobes and less sideband leakage.
- **BlackmanHarris** – Similar to Hanning window, this window has a slightly wider main lobe but much better dynamic range. It is optimized to provide the minimum side lobe level.
- **FlatTop** – Optimized for measuring peak amplitudes of discrete spectral components that are separated by several spectral lines. Recommended for use when your signal content consists of sine waves and amplitude accuracy is important.

- **Exponential** – This window is equal to 1.0 at the beginning of the record and decays exponentially to a smaller value at the end of the record. You can specify a value between 0 and 1 as the *Exp Factor*. This value indicates how much to decay the signal, allowing you to tailor the resultant FFT to the relevant data in the record.

These windowing types are available when generating FFTs for channels that were configured as reference channels; this is a global setting that is applied to the FFTs of all reference channels:

- **Same as Response** – Applies the same windowing function that was selected for the response channels to the FFTs for the reference channels.
- **Force** – This window allows you to specify the percentage of the signal period to which the rectangular window is applied. Data outside the selected percentage is forced to zero.

In the **Start %** field, enter the percentage of the period at which the rectangular window starts. In the **End %** field, enter the percentage of the signal period at which the rectangular window stops.

By applying this window to the output of a transducer, you can avoid collecting extraneous signals, such as forces from the retraction of a hammer, that are not important to the measurement.

- **Cosine Taper** – This window allows you to specify the percentage of the period to allow the signal to come through unaltered before smoothing the signal ends to zero.

## Configuring the Settings of the Output Tab

If your device support analog output channels, you can configure the analog output signal of your device to provide a stimulus to a system under test using the **Output** tab of the Acquisition Config window.

Figure 14 shows the appearance of the Output tab when using the Data Logger interface.

The screenshot displays the 'Output' tab of the Acquisition Config window. It features a table at the top for channel configuration, followed by sections for waveform settings, options, and start/stop methods.

Enable	Channel Name	Waveform	Peak Voltage	Offset
<input checked="" type="checkbox"/>	DT9837-C(00...	Fixed	1	0

**Waveform**

**Signal Type**: Sine  
**Frequency**: 100.00 Hz

**Output Mode**: Burst  
 Repeat burst

**Options**

**Burst On Time**: 1.0000 Sec  
**Burst Off Time**: 0.00000 Sec  
 Lock to acquisition time

**Ramp Up Time**: 0.00000 Sec  
**Ramp Down Time**: 0.00000 Sec

**Start/Stop Method**: With Acquisition  
**Trigger Source**: Software

Buttons: [Speaker icon] [Start]

Figure 14: Output Tab When Using the Data Logger Interface

Figure 15 shows the appearance of the Output tab when using the FFT Analyzer interface.

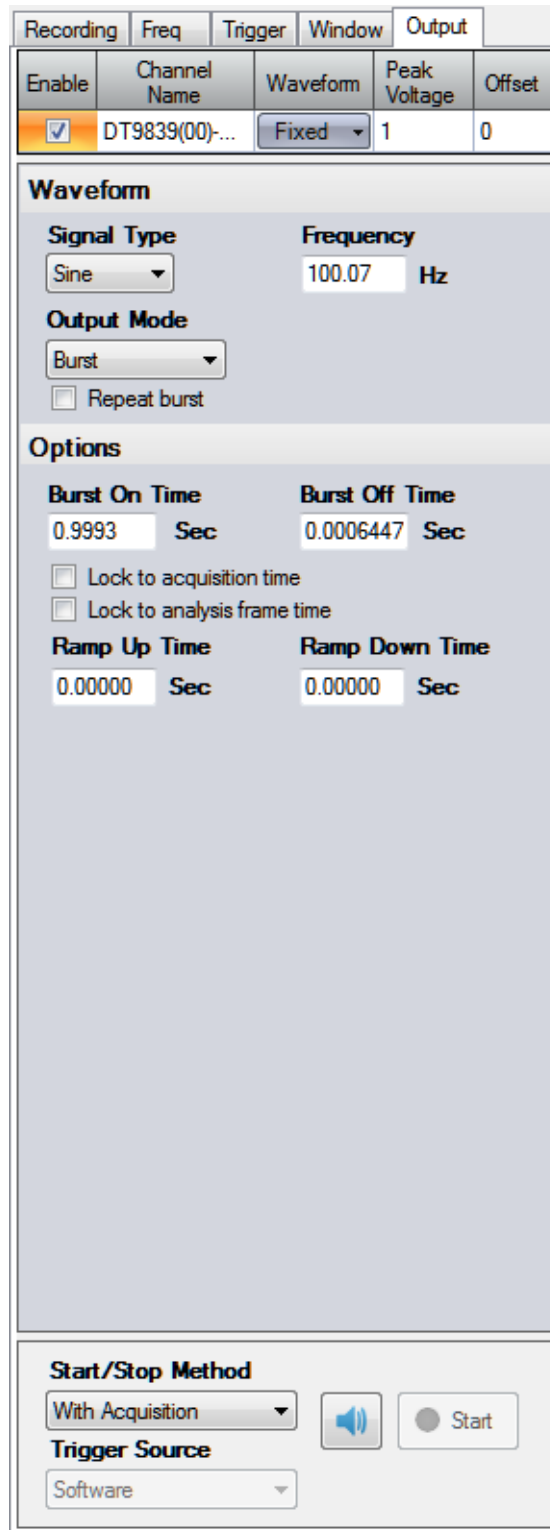

Figure 15: Output Tab When Using the FFT Analyzer Interface

## Enabling Channels

If you want to output an analog signal, enable the analog output channel on the module by clicking the checkbox under the **Enable** column of the **Output** tab.

---

**Note:** Only one analog output channel can be enabled at a time.

---

Note that if you are using multiple devices in a Master/Slave arrangement, only the analog output channel on the master device is available to be enabled.

## Channel Name

The name of the channel is displayed under the **Channel Name** column of the **Output** tab. It cannot be changed.

## Peak Voltage

Enter the voltage of the largest peak to output, measured from 0 V. The output will be  $\pm$  the peak voltage.

## Offset

If desired, enter a value to offset the output signal from the default baseline of 0 V. The default, is 0 V. Choosing a positive value, moves the signal up (above 0 V). Choosing a negative value, moves the signal down (under 0 V).

## Waveform Type

You can choose one of the following waveform types to output:

- **Fixed** – A known output pattern with a fixed frequency.
- **Sweep** – A sine wave whose frequency changes over time.
- **Noise** – A variable waveform that carries a range of frequency components.

Specific parameters are configurable based on the waveform type that you choose. The waveform types and their configurable parameters are described in detail in the following sections.

## Fixed Waveforms

A fixed waveform has a known pattern with a fixed frequency. When you choose a fixed waveform type, the following options are available:

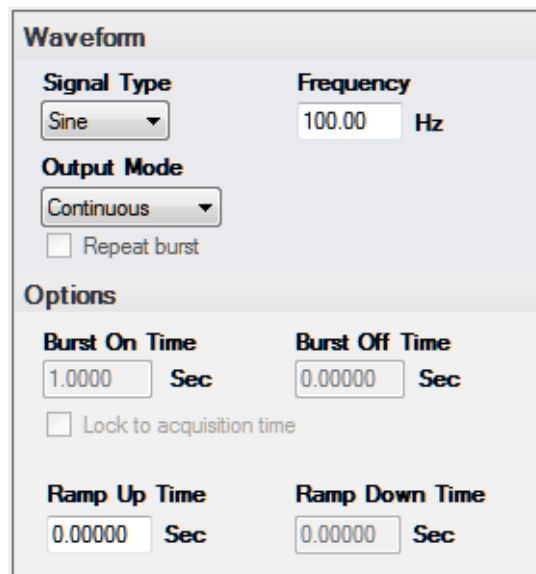

The screenshot shows a configuration window titled "Waveform". It is divided into three sections: "Signal Type", "Output Mode", and "Options".

- Signal Type:** A dropdown menu is set to "Sine". To its right, the "Frequency" is set to "100.00 Hz".
- Output Mode:** A dropdown menu is set to "Continuous". Below it is a checkbox labeled "Repeat burst" which is currently unchecked.
- Options:** This section contains four time-related settings, each with a text input field and a "Sec" label:
  - Burst On Time:** Set to "1.0000 Sec".
  - Burst Off Time:** Set to "0.00000 Sec".
  - A checkbox labeled "Lock to acquisition time" is unchecked.
  - Ramp Up Time:** Set to "0.00000 Sec".
  - Ramp Down Time:** Set to "0.00000 Sec".

---

**Note:** You can change these parameters when the analog output operation is running to change the output signal in real-time.

---

### Signal Type

Specify the pattern of the waveform to output by choosing one of the following signal types:

- **Sine** – A sinusoidal, periodic waveform.
- **Square** – A non-sinusoidal waveform that is shaped like a square, alternating between two levels. (Note that due to the nature of Sigma-Delta converters used on the supported data acquisition devices, you may see variations of the signal at each level.)
- **Ramp** – A non-sinusoidal waveform that ramps up and then drops sharply. This is sometimes called a sawtooth waveform.
- **Triangle** – A non-sinusoidal waveform that is shaped like a triangle.

### Output Frequency

Specify the frequency at which to output the waveform. For fixed waveforms, this frequency is constant for the duration of the waveform.

## Output Mode

You can choose one of the following output modes:

- **Continuous** – In continuous mode, the waveform is output repetitively until acquisition stops if the Start/Stop method is **With Acquisition** or until you stop it with the **Stop** button.
- **Burst** – In burst mode, the waveform is output for a specified amount of time. If the **Repeat Burst** checkbox is unchecked, the waveform is output once. If the **Repeat Burst** checkbox is checked, the burst waveform is output repetitively.

You specify how long the signal is on by specifying the **Burst On Time**. You specify how long the signal is off (signal is at 0 V) by specifying the **Burst Off Time**.

If you are using the Data Logger interface and the **Lock to acquisition time** checkbox is checked, the waveform is output in the time that it takes to acquire the data (specified in the **Recording** tab).

If you are using the FFT Analyzer interface and the **Lock to acquisition time** checkbox is checked, the waveform is output in the time that it takes to do all the averages (an acquisition of all the records specified in the **Recording** tab).

If you are using the FFT Analyzer interface and the **Lock to analysis frame time** checkbox is checked, the waveform is output in the time that it takes to do one average (an acquisition of one record). This option is useful in applications where repeatability is required, such as outputting a repeatable chirp signal.

---

**Notes:** If you are using the FFT Analyzer interface, the **Lock to acquisition time** checkbox is checked, and the Start Method on the **Output** tab is **With Acquisition**, the analog input trigger source should be Freerun or you will be prompted to change it to this setting. This is to guarantee that the analog output data is correlated properly with the analog input data for each record when many averages are performed.

If the **Lock to analysis frame time** checkbox is checked and the Start Method on the **Output** tab is **With Acquisition**, the analog input trigger source should be Software Triggered or you will be prompted to change it to this setting. This is to guarantee that the analog output data is correlated properly with the analog input data for each record when many averages are performed.

---

If you make any changes to the parameters on the Recording tab, Acquisition tab, or Freq tab, the values are automatically updated on the Output tab.

## Ramp Up Time and Ramp Down Time

If desired, you can determine how long it takes for the signal to ramp up at the start of the waveform to the specified peak voltage by specifying the **Ramp Up Time**.

If the output mode is **Burst**, you can also specify how long it takes for the signal to ramp down to 0 V at the end of the waveform by specifying the **Ramp Down Time**.



**Example**

Figure 16 shows a sine wave with a fixed frequency of 10 Hz, a peak voltage of 3 V, an offset of 0 V, a Burst On Time of 3 seconds, a Ramp Up time of 1.0 second and a Ramp Down time of 1.0 second:

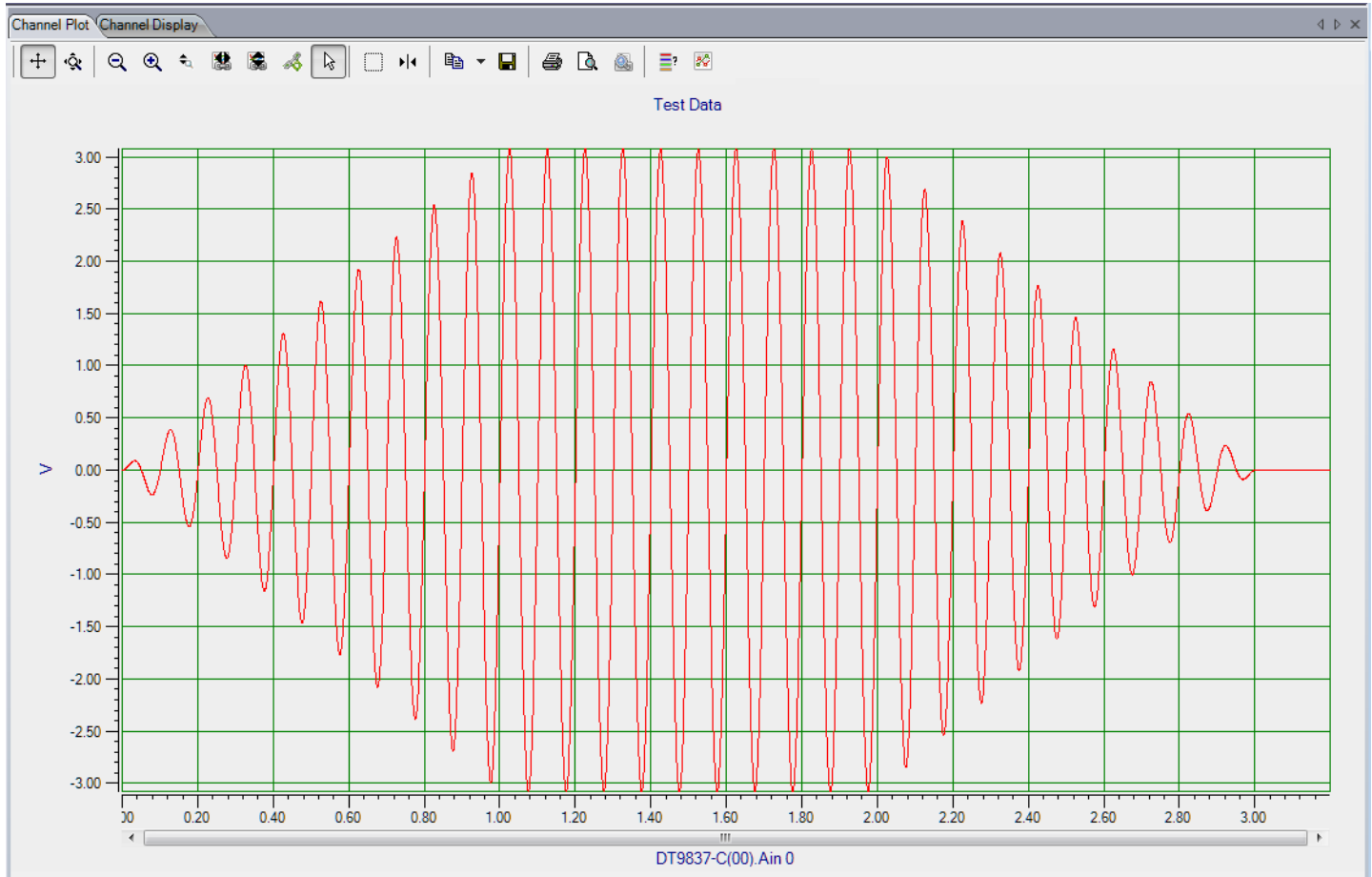

**Figure 16: Fixed Sine Wave with Modified Burst On Time and Ramp Up/Ramp Down Time**

## Sweep Waveforms

A sweep waveform is a sine wave whose frequency changes over time. Swept sine waves allow you to test a device over a wide frequency range to determine if any resonances occur.

If you are using the Data Logger interface, the following options are available when you choose the Sweep waveform type:

The screenshot shows a software interface with three tabs: Recording, Acquisition, and Output. The Acquisition tab is active. Below the tabs is a table with the following data:

Enable	Channel Name	Waveform	Peak Voltage	Offset
<input checked="" type="checkbox"/>	DT9837-C(00...	Sweep	1	0

Below the table is a section titled "Waveform" with the following settings:

- Sweep Mode:** Single
- Start Frequency:** 100.00 Hz
- Freq Change:** Linear
- End Frequency:** 1000.00 Hz

Below the "Waveform" section is a section titled "Options" with the following settings:

- Sweep On Time:** 1.0000 Sec
- Sweep Off Time:** 0.00000 Sec
- Lock to acquisition time
- Ramp Up Time:** 0.00000 Sec
- Ramp Down Time:** 0.00000 Sec

Figure 17: Sweep Waveform Options for the Data Logger Interface

If you are using the FFT Analyzer interface, the following options are available when you choose the Sweep waveform type:

Recording	Freq	Trigger	Window	Output
Enable	Channel Name	Waveform	Peak Voltage	Offset
<input checked="" type="checkbox"/>	DT9837-C(00...	Sweep	3	0

Waveform	
<b>Sweep Mode</b>	<b>Start Frequency</b>
Single	100.00 Hz
<b>Freq Change</b>	<b>End Frequency</b>
Linear	1000.00 Hz
Options	
<b>Sweep On Time</b>	<b>Sweep Off Time</b>
1.0000 Sec	1.0000 Sec
<input type="checkbox"/> Lock to acquisition time	
<input type="checkbox"/> Lock to analysis frame time	
<b>Ramp Up Time</b>	<b>Ramp Down Time</b>
1.00000 Sec	0.00000 Sec

Figure 18: Sweep Waveform Options for the FFT Analyzer Interface

---

**Note:** You can change these parameters when the analog output operation is running to change the output signal in real-time.

---

### Sweep Mode

Specify one of the following sweep modes:

- **Loop** – In loop mode, the swept sine wave repeats continuously.
- **Single** – In single mode, the swept sine wave is output once.

### Frequency Change

Specify how you want the frequency of the waveform to change over time by selecting one of the following values for the **Freq Change** combo box:

- **Linear** – The frequency increases at a fixed rate of frequency per time (Hz/s).
- **Log** – In this mode, the frequency increases at a fixed rate of octave change per time (Octave/s). This is also called an exponential sweep.

### Start and End Frequencies

In the **Start Frequency** field, specify the frequency of the waveform when it starts.

In the **End Frequency** field, specify the frequency of the waveform when it ends.

If you want a swept sine wave that increases in frequency over time, ensure that the ending frequency is greater than the starting frequency; this is sometimes called a chirp. If you want a swept sine wave that decreases in frequency over time, ensure that the ending frequency is less than the starting frequency.

### Sweep On Time and Sweep Off Time

You specify how long the signal is on by specifying the **Sweep On Time**. You specify how long the signal is off (signal is at 0 V) by specifying the **Sweep Off Time**.

If you are using the Data Logger interface and the **Lock to acquisition time** checkbox is checked, the waveform is output in the time that it takes to acquire the data (specified in the **Recording** tab).

If you are using the FFT Analyzer interface and the **Lock to acquisition time** checkbox is checked, the waveform is output in the time that it takes to do all the averages (an acquisition of all the records specified in the **Recording** tab).

If you are using the FFT Analyzer interface and the **Lock to analysis frame time** checkbox is checked, the waveform is output in the time that it takes to do one average (an acquisition of one record). This option is useful in applications where repeatability is required, such as outputting a repeatable chirp signal.

---

**Notes:** If you are using the FFT Analyzer interface, the **Lock to acquisition time** checkbox is checked, and the Start Method on the **Output** tab is **With Acquisition**, the analog input trigger source should be Freerun or you will be prompted to change it to this setting. This is to guarantee that the analog output data is correlated properly with the analog input data for each record when many averages are performed.

If the **Lock to analysis frame time** checkbox is checked and the Start Method on the **Output** tab is **With Acquisition**, the analog input trigger source should be Software Triggered or you will be prompted to change it to this setting. This is to guarantee that the analog output data is correlated properly with the analog input data for each record when many averages are performed.

---

If you make any changes to the parameters on the Recording tab, Acquisition tab, or Freq tab, the values are automatically updated on the Output tab.

## Ramp Up Time and Ramp Down Time

If desired, you can determine how long it takes for the signal to ramp up at the start of the waveform to the specified peak voltage by specifying the **Ramp Up Time**.

You can also specify how long it takes for the signal to ramp down to 0 V at the end of the waveform by specifying the **Ramp Down Time**.

## Examples

Figure 19 shows a linear swept sine wave from 1 to 30 Hz.

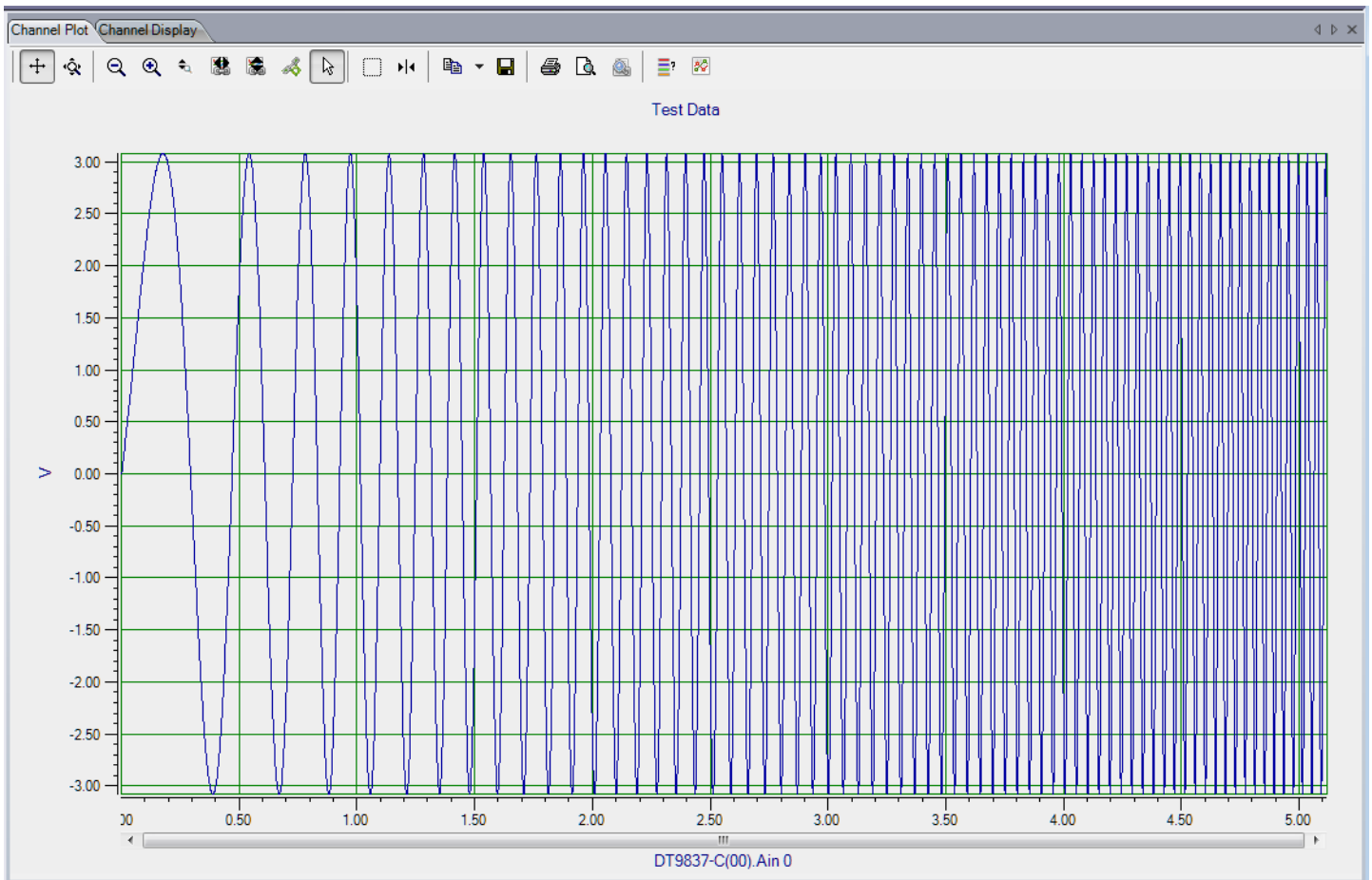
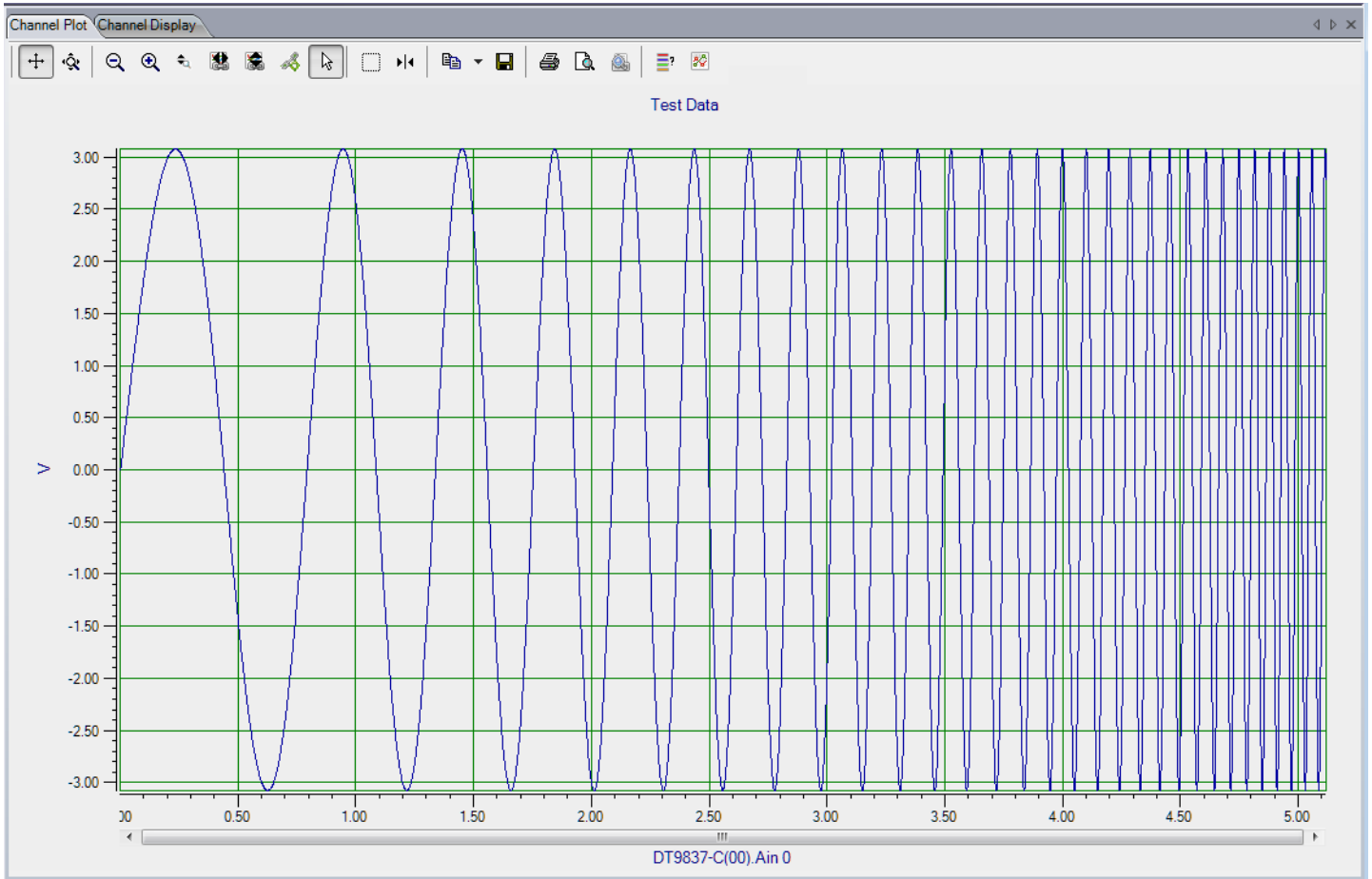

Figure 19: Linear Swept Sine Wave from 1 to 30 Hz

Figure 20 shows a logarithmic swept sine wave from 1 to 30 Hz.



**Figure 20: Logarithmic Swept Sine Wave from 1 to 30 Hz**

Figure 21 shows a logarithmic swept sine wave from 1 to 100 Hz with a Sweep On time of 3.0 s, a Sweep Off time of 2.0 s, a Ramp Up time of 1.0 s, and a Ramp Down time of 2.0 s.

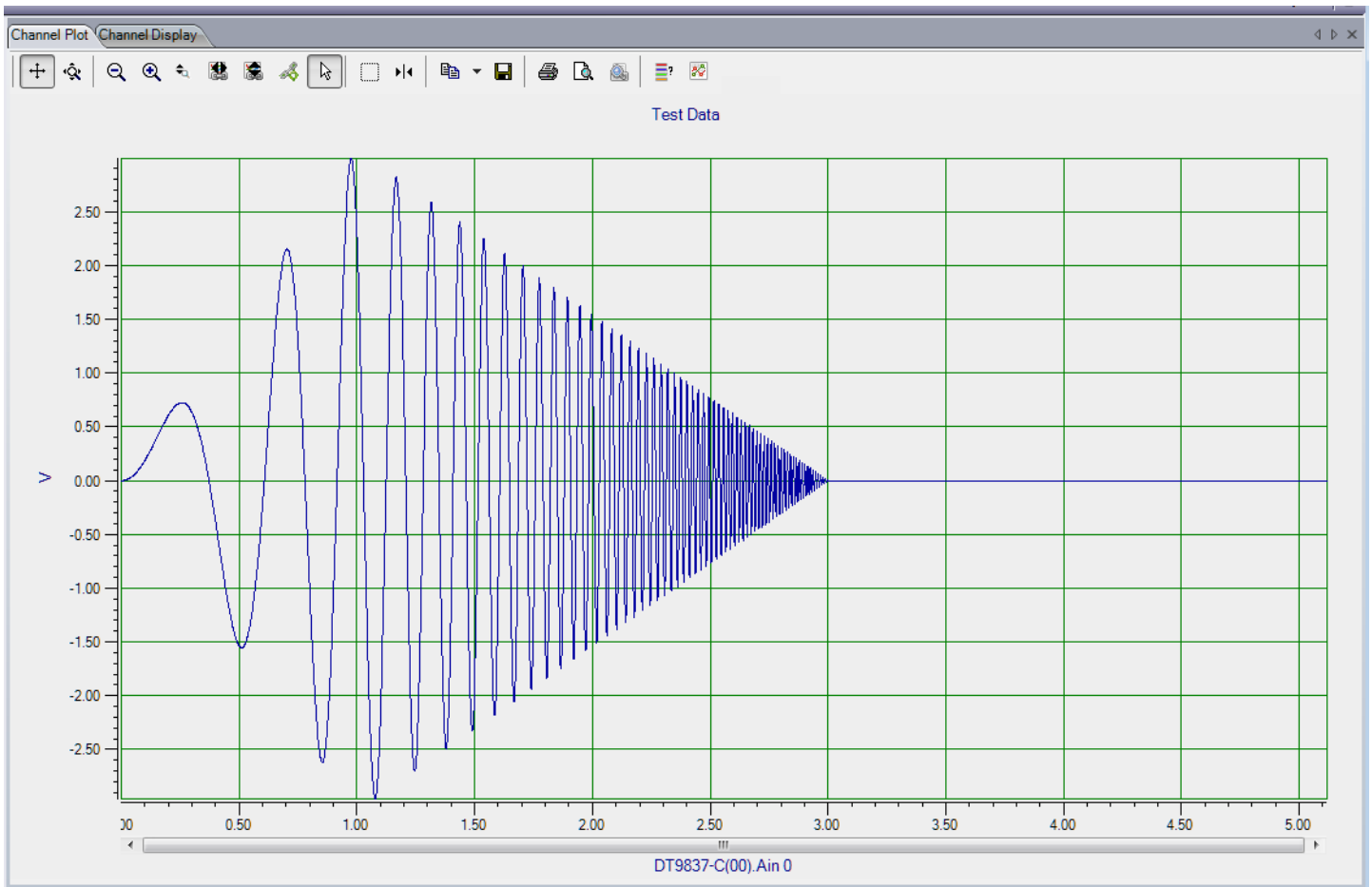
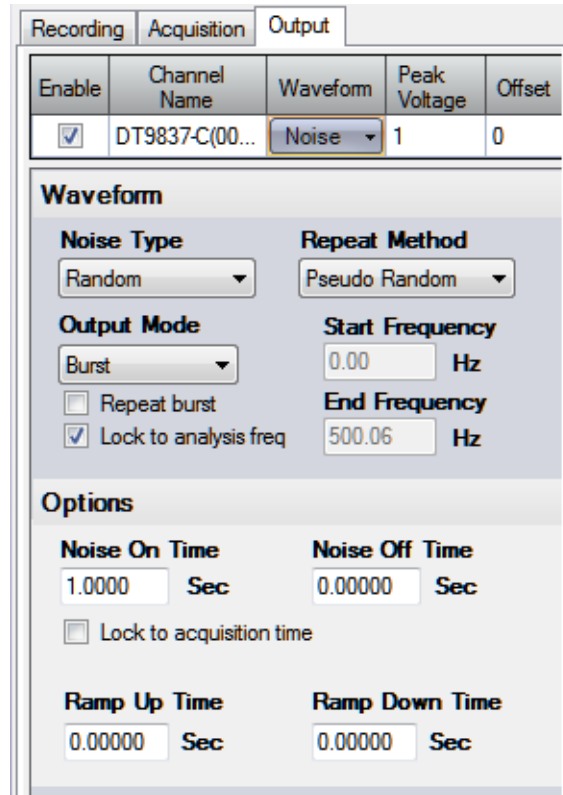

**Figure 21: Logarithmic Swept Sine Wave from 1 to 100 Hz with Modified Sweep On/Off Times and Ramp Up/Down Times**

## Noise Waveforms

A noise waveform is a variable waveform that carries a range of frequency components, allowing you to uncover resonances at a variety of frequencies.

If you are using the Data Logger interface and choose a noise waveform type, the following options are available:



Enable	Channel Name	Waveform	Peak Voltage	Offset
<input checked="" type="checkbox"/>	DT9837-C(00...	Noise	1	0

**Waveform**

**Noise Type**: Random

**Repeat Method**: Pseudo Random

**Output Mode**: Burst

Repeat burst

Lock to analysis freq

**Start Frequency**: 0.00 Hz

**End Frequency**: 500.06 Hz

**Options**

**Noise On Time**: 1.0000 Sec

**Noise Off Time**: 0.00000 Sec

Lock to acquisition time

**Ramp Up Time**: 0.00000 Sec

**Ramp Down Time**: 0.00000 Sec

Figure 22: Noise Waveform Options Using the Data Logger Interface

If you are using the FFT Analyzer interface and choose a noise waveform type, the following options are available:



Recording	Freq	Trigger	Window	Output
Enable	Channel Name	Waveform	Peak Voltage	Offset
<input checked="" type="checkbox"/>	DT9837-C(00...	Noise	3	0

**Waveform**

**Noise Type**  
Random

**Repeat Method**  
Pseudo Random

**Output Mode**  
Burst

Repeat burst

Lock to analysis freq

**Start Frequency**  
0.00 Hz

**End Frequency**  
10000.00 Hz

**Options**

**Noise On Time**  
1.0000 Sec

**Noise Off Time**  
1.0000 Sec

Lock to acquisition time

Lock to analysis frame time

**Ramp Up Time**  
1.00000 Sec

**Ramp Down Time**  
0.00000 Sec

Figure 23: Noise Waveform Options Using the FFT Analyzer Interface

---

**Note:** You can change these parameters when the analog output operation is running to change the output signal in real-time.

---

### Noise Type

Specify the type of noise waveform to output by choosing one of the following signal types:

- **Random** – A noise signal with a power spectral density that remains constant over the entire noise bandwidth and an amplitude histogram that exhibits a constant distribution.

Figure 24 shows a random noise signal (from 0 Hz to 200 Hz) in the time domain.

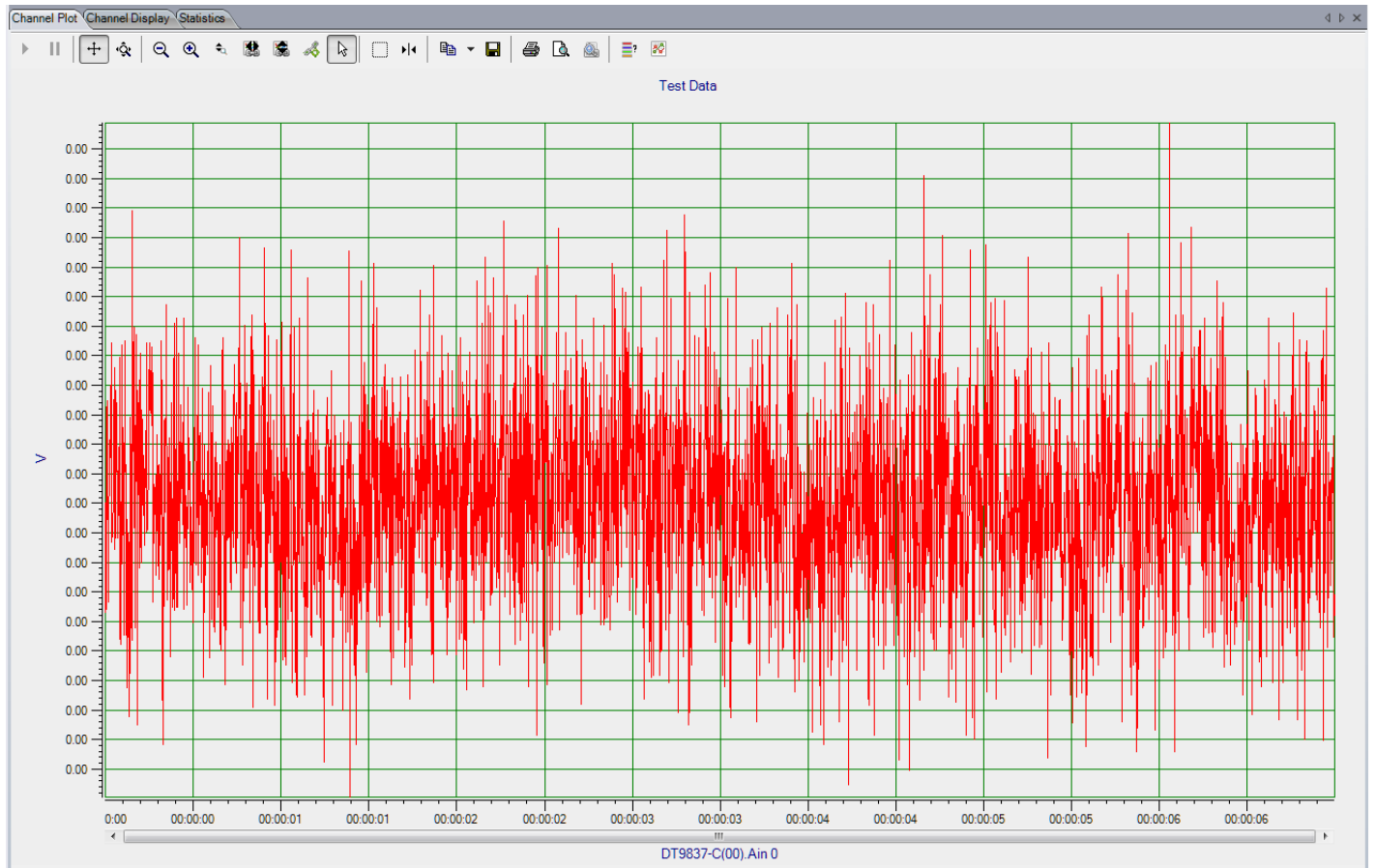

**Figure 24: Random Noise Signal**

Figure 25 shows a histogram of the random noise in the time domain. As you can see, the amplitudes in the time domain form a flat histogram.

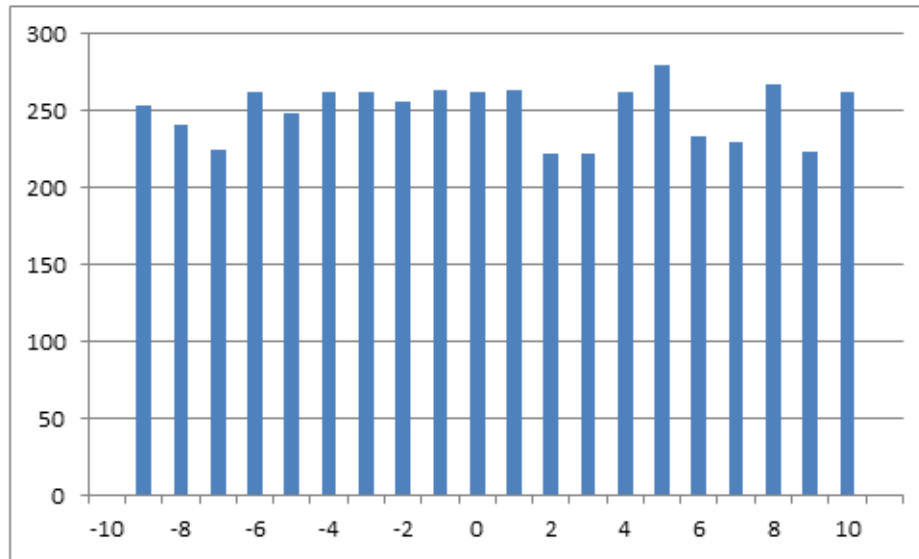
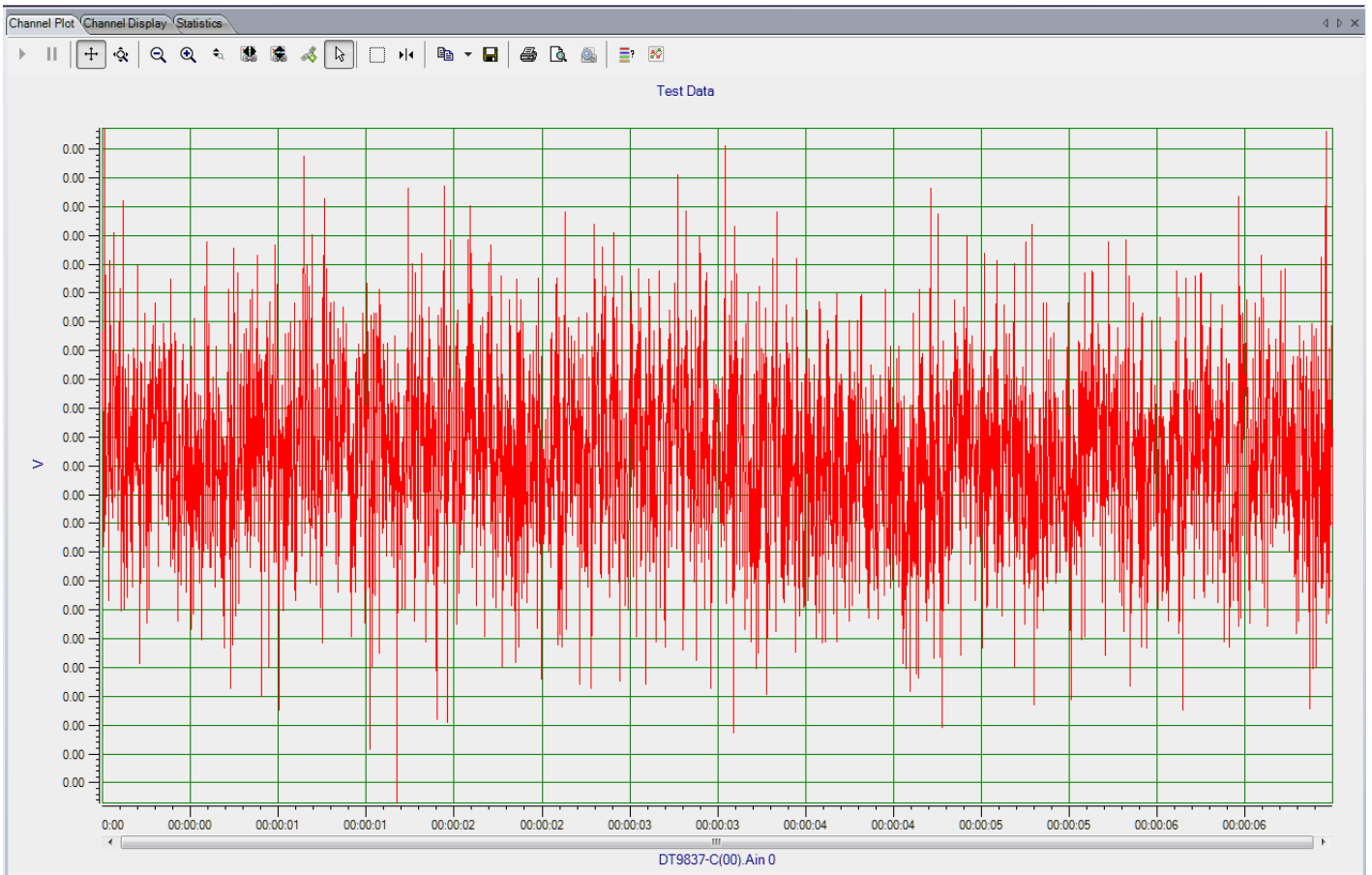

**Figure 25: Histogram of Random Noise in the Time Domain Shows a Flat Distribution**

- **Random Normal** – A noise signal with a power spectral density that remains constant over the entire noise bandwidth and an amplitude histogram that exhibits a Gaussian distribution.

The software creates random normal noise by implementing the Box-Muller transform.

[Figure 26](#) shows a random normal noise signal (from 0 Hz to 200 Hz) in the time domain.



**Figure 26: Random Normal Noise Signal**

Figure 27 shows a histogram of the random normal noise in the time domain. As you can see, the amplitudes in the time domain form a Gaussian histogram.

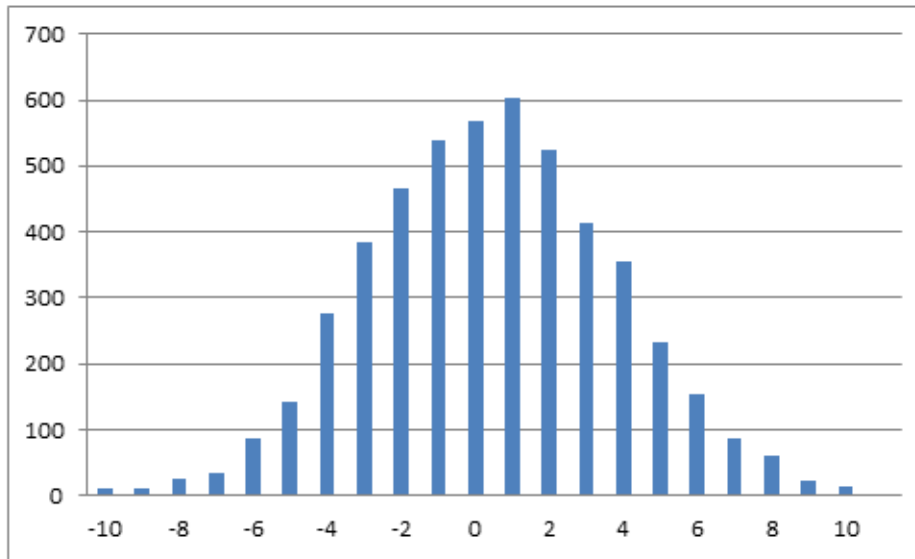

**Figure 27: Histogram of Random Normal Noise in the Time Domain Shows a Gaussian Distribution**

- **Pink (1/f Noise)** – A noise signal with a power spectral density that is inversely proportional to the frequency. Each octave contains an equal amount of noise power. [Figure 28](#) shows a pink noise signal (from 0 Hz to 10 kHz) in the time domain.

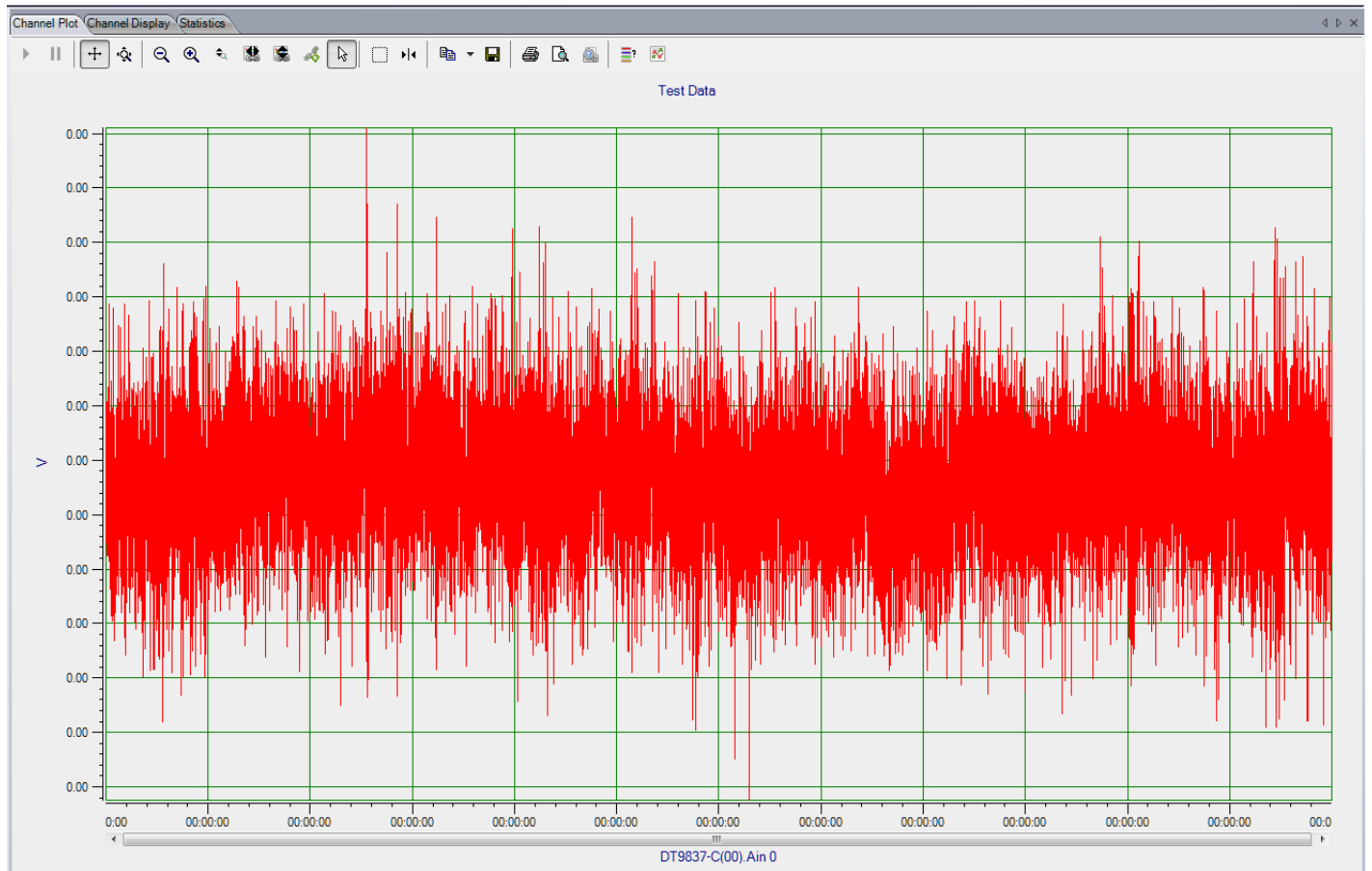

**Figure 28: Pink Noise Signal**

Figure 29 shows a histogram of the pink noise in the time domain.

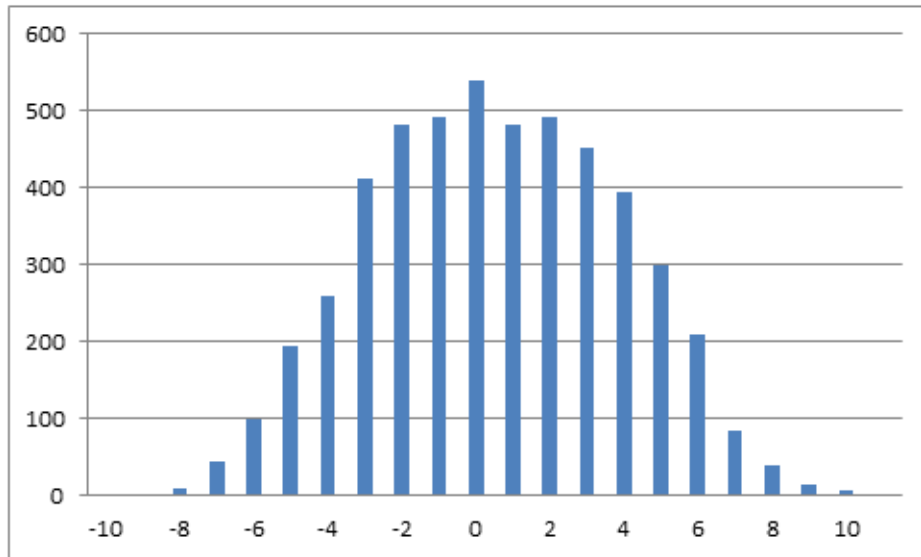

**Figure 29: Histogram of Pink Noise in the Time Domain**

### Output Mode

You can choose one of the following output modes for noise waveforms:

- **Continuous** – In continuous mode, the waveform is output repetitively until acquisition stops if the Start/Stop method is **With Acquisition** or until you stop it with the **Stop** button.
- **Burst** – In burst mode, the waveform is output for a specified amount of time. If the **Repeat Burst** checkbox is unchecked, the waveform is output once. If the **Repeat Burst** checkbox is checked, the burst waveform is output repetitively.

You specify how long the signal is on by specifying the **Burst On Time**. You specify how long the signal is off (signal is at 0 V) by specifying the **Burst Off Time**.

If you are using the Data Logger interface and the **Lock to acquisition time** checkbox is checked, the waveform is output in the time that it takes to acquire the data (specified in the **Recording** tab).

If you are using the FFT Analyzer interface and the **Lock to acquisition time** checkbox is checked, the waveform is output in the time that it takes to do all the averages (an acquisition of all the records specified in the **Recording** tab).

If you are using the FFT Analyzer interface and the **Lock to analysis frame time** checkbox is checked, the waveform is output in the time that it takes to do one average (an acquisition of one record). This option is useful in applications where repeatability is required, such as outputting a repeatable chirp signal.

**Notes:** If you are using the FFT Analyzer interface, the **Lock to acquisition time** checkbox is checked, and the Start Method on the **Output** tab is **With Acquisition**, the analog input trigger source should be Freerun or you will be prompted to change it to this setting. This is to guarantee that the analog output data is correlated properly with the analog input data for each record when many averages are performed.

If the **Lock to analysis frame time** checkbox is checked and the Start Method on the **Output** tab is **With Acquisition**, the analog input trigger source should be Software Triggered or you will be prompted to change it to this setting. This is to guarantee that the analog output data is correlated properly with the analog input data for each record when many averages are performed.

---

If you make any changes to the parameters on the Recording tab, Acquisition tab, or Freq tab, the values are automatically updated on the Output tab.

### **Ramp Up Time and Ramp Down Time**

If desired, you can determine how long it takes for the signal to ramp up at the start of the waveform to the specified peak voltage by specifying the **Ramp Up Time**.

If the output mode is **Burst**, you can also specify how long it takes for the signal to ramp down to 0 V at the end of the waveform by specifying the **Ramp Down Time**.

### **Output Frequency**

If you check the **Lock to analysis freq** checkbox, the maximum frequency of the noise waveform is locked to the maximum frequency to analyze (specified in the **Acquisition** tab for the Data Logger interface or the **Freq** tab for the FFT Analyzer interface).

If the **Lock to analysis freq** checkbox is unchecked, you can specify the starting frequency component and the ending frequency component in the generated signal.

### **Repeat Method**

You can choose one of the following repeat methods for noise waveforms:

- **True Random** – Generates a new noise signal of the specified waveform pattern (Random, Random Normal, or Pink) for each burst period.

A true random signal is always nonperiodic during the total acquisition time. Therefore, a time domain window, such as a Hanning window, must be used with this repeat mode to minimize leakage.

- **Pseudo Random** – Repeats the last output signal for the specified noise waveform type (Random, Random Normal, or Pink).

A pseudo random signal does not excite nonlinearities differently between spectrum averages; therefore, spectrum averaging will not remove nonlinearities from FRF measurements.

However, the excitation signal is completely contained in the total acquisition time, and is therefore, periodic during the total acquisition time and without leakage.



## Start/Stop Methods

To start the waveform generation operation, you can choose one of the following options:

- **With Acquisition** – Choose this option if you want the device to output the specified waveform when acquisition starts.



---

**Note:** If you choose **With Acquisition** and the analog output channel is enabled, ensure that you select an analog input trigger source other than a threshold trigger, or you will be prompted to change the analog input trigger source.

If you are using the FFT Analyzer interface and you choose **With Acquisition** when the **Lock to acquisition time** checkbox is selected, the analog input trigger source should be Freerun or you will be prompted to change it to this setting. This is to guarantee that the analog output data is correlated properly with the analog input data for each record when many averages are performed.

If you are using the FFT Analyzer interface and you choose **With Acquisition** when the **Lock to analysis frame time** checkbox is checked, the analog input trigger source should be Software Triggered or you will be prompted to change it to this setting. This is to guarantee that the analog output data is correlated properly with the analog input data for each record when many averages are performed.

---

- **Manual** – Choose this option if you want the device to output the specified waveform when one of the following trigger conditions is detected:
  - **Software** – The operation starts immediately when the **Record** button  on the **Output** tab is clicked.
  - **Ext TTL Pos Edge** – After the **Start** button  on the **Output** tab is clicked, the operation starts when the device detects a positive edge on the external digital trigger line.

You can stop the waveform output operation by stopping acquisition or by clicking the **Stop** button  on the **Output** tab. When the waveform is stopped, the specified offset value is output.

## Muting and Unmuting the Output Signal

If your device supports it, you can mute the output in hardware by clicking the **Unmute** button . This forces the output to 0 V, as shown in [Figure 30](#).

---

**Note:** The number of samples it takes for the mute process to complete is hardware dependent. Refer to the user's manual for your device for more information.

---

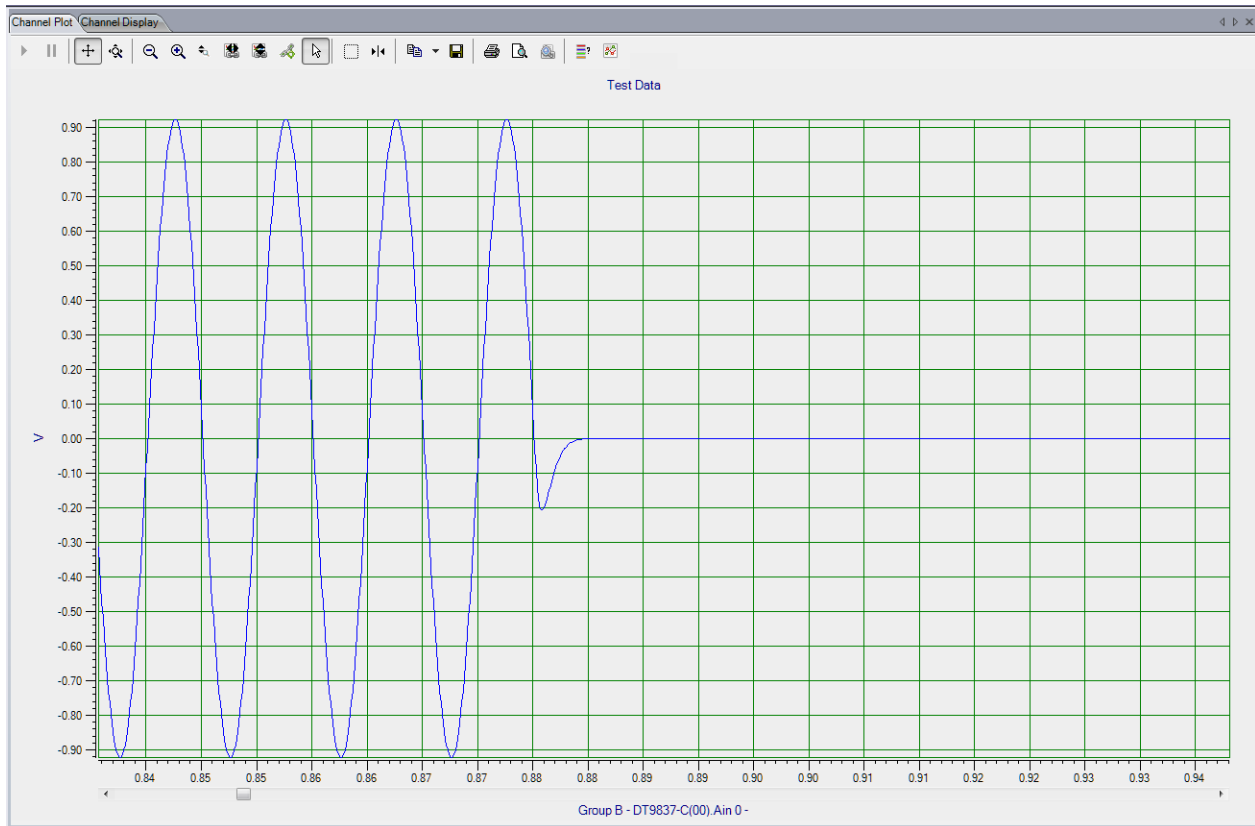

**Figure 30: Muting the Output Signal**

---

**Note:** Mute is also activated if you click the **Stop** button on the main interface or on the Output tab, causing the analog output operation to stop.

---

To unmute the output, click the **Mute** button . The output pattern that you selected resumes at the current level, as shown in [Figure 31](#).

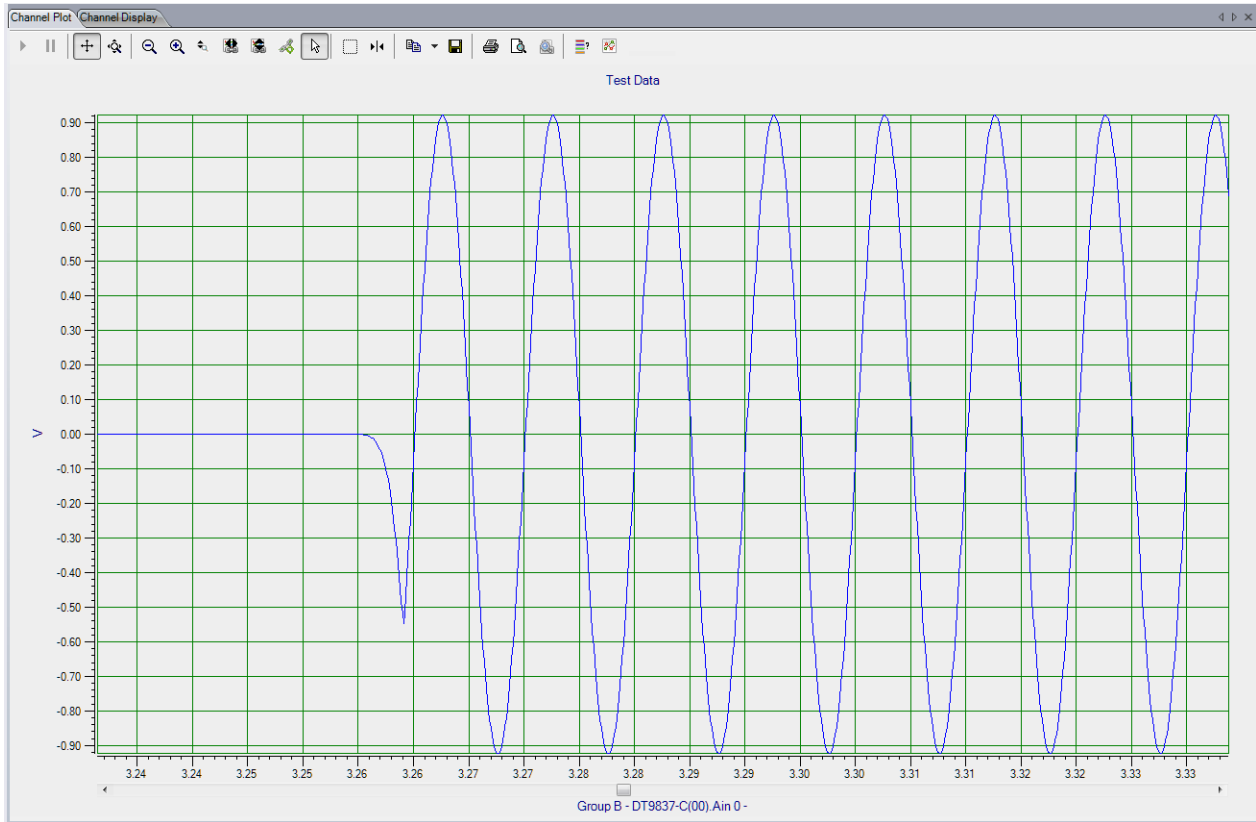



Figure 31: Unmuting the Output Signal

## Configuring Digital Filters

**Notes:** To configure digital filters, you must have purchased the **FFT Analysis Option** or the **Advanced FFT Analysis Option** of QuickDAQ.

Choose the **Digital Filter Configuration** toolbar button (  ) or the **Digital Filter Configuration** option from the **Configuration** menu to configure IIR (infinite impulse response) filters for the analog input channels. The Digital Filter Configuration dialog appears. [Figure 32](#) shows an example of the Digital Filter Configuration dialog.

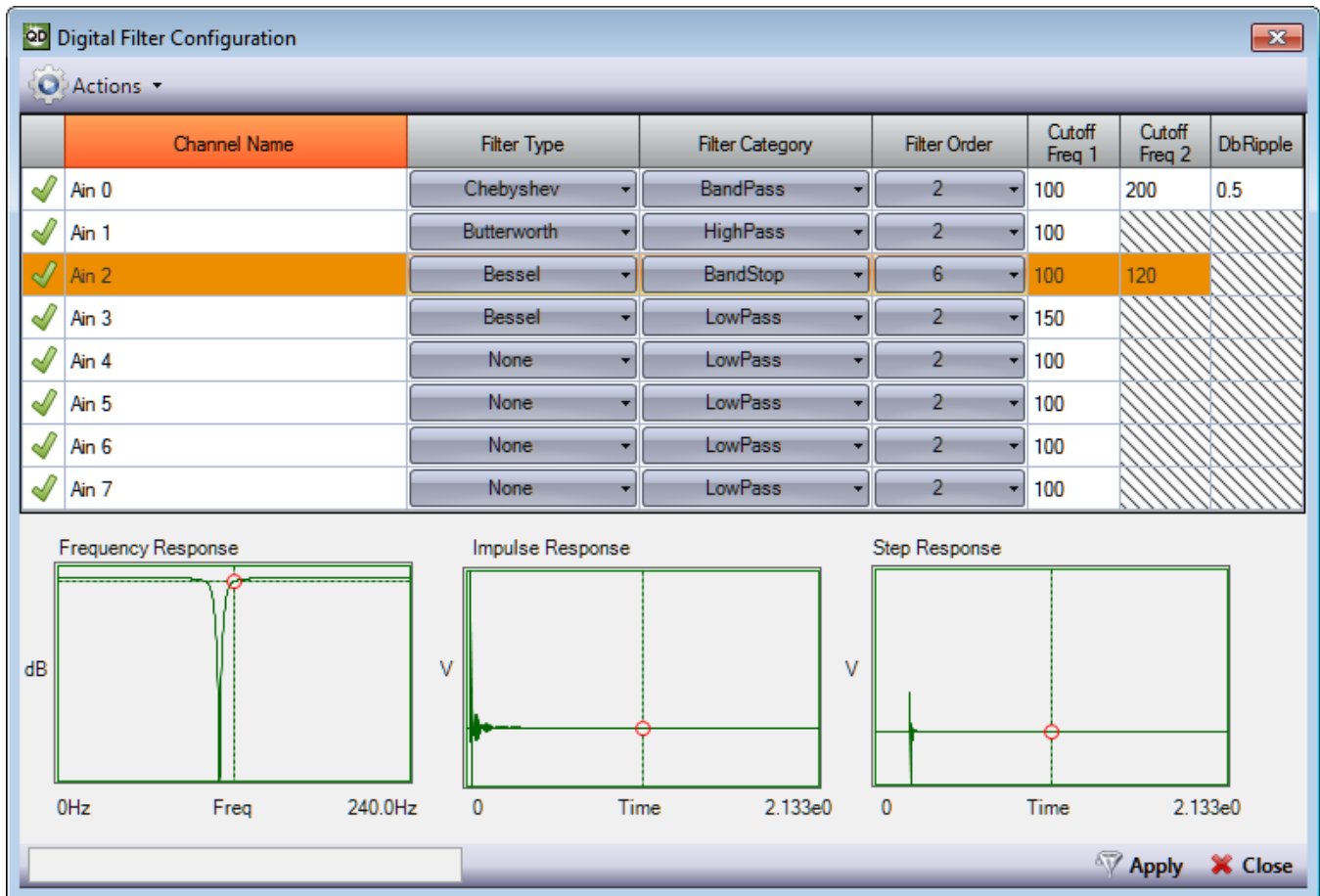

Figure 32: Digital Filter Configuration Dialog

---

**Note:** The settings used by the Digital Filter Configuration dialog depend on the sampling or analysis frequency. Therefore, it is recommended that you set up the sampling/analysis frequency before using the Digital Filter Configuration dialog.

If you later change the sampling/analysis frequency, the application may notify you that one or more filters have been invalidated. If this occurs, it is recommended that you change your filter settings based on the new sampling/analysis frequency.

If you are using the Data Logger interface, refer to [page 127](#) for more information on setting the sampling frequency. If you are using the FFT Analyzer interface, refer to [page 130](#) for more information on setting the analysis frequency.



---

## Channels and Filter Status Indicators

All the analog input channels that are supported by your device, whether they are enabled or not in the Configure Devices dialog, are shown in the Digital Filter Configuration dialog.

By default, the status indicator for each channel is shown as Stable | .

As you choose various filter settings for the channel (before you click the **Apply** button), the indicator changes to In Process | .

Once you apply the changes, the status indicator either indicates that the filter is Stable | , or Unstable | .

A stable filter assures that every limited input signal produces a limited filter response. An unstable filter cannot be qualified, and in some situations may prove useless or even harmful. Therefore, it is important that you choose the settings for your filters carefully to avoid instability.

## Filter Types

You can select one of the following filter types to apply to each analog input channel:

- None – No digital filter.
- Bessel – A linear filter with a maximally flat group delay (maximally linear phase response). Bessel filters are often used in audio applications. Bessel filters are characterized by almost constant group delay across the entire passband, thus preserving the wave shape of filtered signals in the passband.
- Butterworth – A maximally flat magnitude filter, with no ripples in the passband or stopband.
- Chebyshev – This filter type minimizes the error between the idealized and the actual filter characteristic over the range of the filter, but with ripples in the passband. It has a steeper roll-off and more passband ripple or stopband ripple than Butterworth filters.

If you want to set the same filter type for all channels at once, select the **Multi-channel Actions** button (  **Actions** ▾ ), choose **Set all Filter Types**, and select the filter type (None, Bessel, Butterworth, or Chebyshev) that you want to use.

## Filter Category and Cutoff Frequency

You can further refine the type of filter to apply by selecting one of the following filter categories:

- **LowPass** – A low-pass filter is used to eliminate unwanted high-frequency signals by passing low-frequency signals and attenuating (reducing the amplitude of) signals with frequencies higher than the cutoff frequency. The actual amount of attenuation for each frequency varies depending on the specific filter type.

When you select **LowPass**, enter the cutoff frequency above which signals will be attenuated.

- **HighPass** – A high-pass filter is used to eliminate any unwanted low frequency components by passing high-frequency signals and attenuating signals with frequencies lower than the cutoff frequency. The actual amount of attenuation for each frequency varies depending on the specific filter type.

When you select **HighPass**, enter the cutoff frequency below which signals will be attenuated.

- **BandPass** – A band-pass filter is a combination of a low-pass and a high-pass filter. It passes frequencies within a certain range and rejects (attenuates) frequencies outside of that range.

When you select **BandPass**, enter the cutoff frequency below which (**Cutoff Freq 1**) and above which (**Cutoff Freq 2**) signals will be attenuated.

- **BandStop** – A band-stop filter passes most frequencies unaltered, but attenuates those in a specific range to very low levels. It is the opposite of a band-pass filter. A very narrow band-stop filter is known as a notch filter.

When you select **BandStop**, enter the cutoff frequency below which (**Cutoff Freq 1**) and above which (**Cutoff Freq 2**) signals will be attenuated.

If you want to set the same filter category for all channels at once, select the **Multi-channel Actions** button (  **Actions** ▾ ), choose **Set all Filter Categories**, and select the filter category (LowPass, HighPass, BandPass, or BandStop) that you want to use.

## Filter Order

The filter order (also known as the number of poles) determines the rejection characteristics of the filter. The greater the filter order, the greater the rejection, yielding a steeper rolloff. You can select a number from 1 to 10 for the filter order.

If you want to set the filter order for all channels at once, select the **Multi-channel Actions** button (  **Actions** ▾ ), choose **Set all Filter Orders**, and select the filter order (1 to 10) that you want to use.

## dB Ripple

For Chebyshev filters, specify the ripple, in dB, that you want in the passband.

## Frequency Response Graph

The frequency response graph shows the output of the specified filter as a function of frequency. When you select a channel, you can see the frequency response graph based on the specified filter settings, where dB is plotted on the y-axis and frequency is plotted on the x-axis.

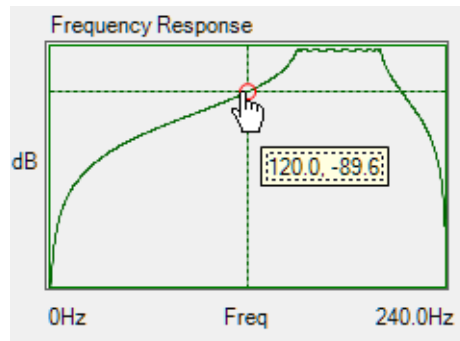

Using your mouse, you can use the left-click button to move along the frequency response graph to see the frequency and dB values.

## Impulse Response Graph

The impulse response graph shows the reaction of the specified filter as a function of time. When you select a channel, you can see the impulse response graph based on the specified filter settings, where voltage is plotted on the y-axis and time, in seconds, is plotted on the x-axis.

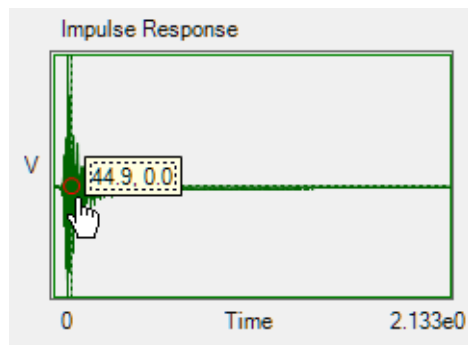

Using your mouse, you can use the left-click button to move along the impulse response graph to see the time and voltage values.

## Step Response Graph

The step response graph shows the time behavior of the filter when its inputs change from zero to one in a very short time. When you select a channel, you can see the step response graph based on the specified filter settings, where voltage is plotted on the y-axis and time, in seconds, is plotted on the x-axis.

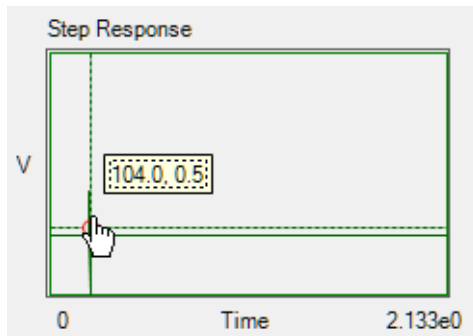

Using your mouse, you can use the left-click button to move along the step response graph to see the time and voltage values.





# ***Configuring the Display of the Data Logger Interface***

Introduction.....	170
Configuring the Appearance of the Channel Plot Window.....	171
Configuring the Appearance of the Channel Display Window .....	182
Configuring the Appearance of the Statistics Window .....	188

## ***Introduction***

This chapter describes how to configure the display when using the Data Logger interface. If you are using the FFT Analyzer interface, refer to [Chapter 6 starting on page 191](#).

## Configuring the Appearance of the Channel Plot Window

This section describes the following aspects related to the appearance of the Channel Plot window when using the Data Logger interface:

- Displaying channels in the Channel Plot window, described on this page
- Displaying data cursors in the Channel Plot window, described on [page 173](#)
- Specifying the columns of the Channel Plot window, described on [page 174](#)
- Grouping signals in bands on the Channel Plot window, described on [page 176](#)
- Specifying the trace color on the Channel Plot window, described on [page 178](#)
- Controlling how data is plotted the Channel Plot window, described on [page 179](#)
- Specifying the style of the plots in the Channel Plot window, described on [page 181](#)

### Displaying Channels in the Channel Plot Window

You can determine which channels are displayed in the Channel Plot window by using the following controls in the Plot and Data Config window:

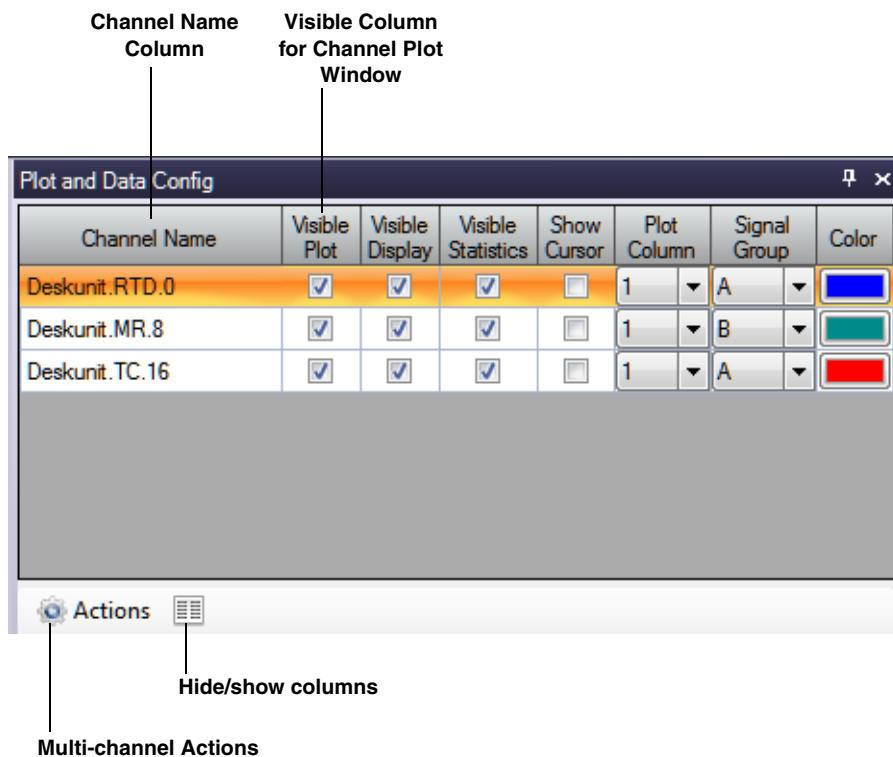

You can see the names of all enabled channels under the **Channel Name** column in the Plot and Data Config window. Only data from the list of enabled channels is acquired.

---

**Note:** If desired, you can change the name of a channel using the **Input Channel Configuration** menu option, described on [page 86](#).

---

For each enabled channel listed under the **Channel Name** column, you can control which channels are displayed in the Channel Plot window using the **Visible Plot** checkbox. If a box is checked under the **Visible Plot** column, a plot for the associated channel is displayed in the Channel Plot window. If a box under the **Visible Plot** column is unchecked, the plot for the associated channel is not displayed in the Channel Plot window.

---

**Note:** Data for all enabled channels is recorded regardless of whether the channel is visible.

---

### ***Making All Selected Channels Visible or Hidden in the Channel Plot Window at Once***

If you want to make all selected channels visible in the Channel Plot window at once, select the **Multi-channel Actions** button (  **Actions** ▾ ), and choose **Selected channels visible in Channel Plot**.

If you want to hide all selected channels in the Channel Plot window at once, select the **Multi-channel Actions** button (  **Actions** ▾ ), and choose **Selected channels hidden in Channel Plot**.

### ***Showing or Hiding the Visible Plot Column***

If you wish, you can change whether the **Visible Plot** column is shown or hidden by selecting the **Hide/show columns** (  ) button, and selecting **Visible Plot**. A checkmark means the column is shown; no checkmark means the column is hidden.

### ***Moving the Visible Plot Column***

If you wish, you can move the position of the **Visible Plot** column by clicking the left-mouse button to select it, dragging it to the right or left, and letting go of the left-mouse button.

## Displaying Data Cursors in the Channel Plot Window

You can determine whether data cursors are displayed in the Channel Plot window by using the following controls in the Plot and Data Config window:

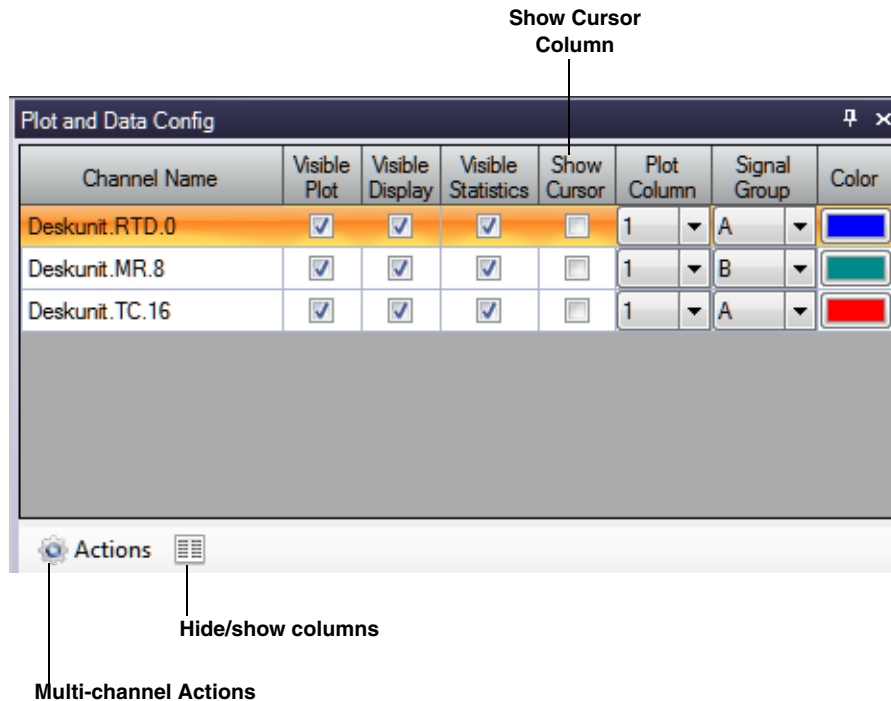

For each of the enabled channels, you can choose to display a data cursor in the Channel Plot window using the **Show Cursor** column in the Plot and Data Config window.

If a box is checked under the **Show Cursor** column, a data cursor for the associated channel is displayed in the Channel Plot window. If a box under the **Show Cursor** column is unchecked, a data cursor for the associated channel is not displayed in the Channel Plot window.

You can enable the capability of moving the data cursor using the data-cursor control (  ), described on [page 75](#). Various options are available for changing the cursor style, line style, and cursor color.

### ***Making All Selected Data Cursors Visible or Hidden at Once***

If you want to make all selected data cursors visible in the Channel Plot window at once, select the **Multi-channel Actions** button (  **Actions** ▼ ), and choose **Selected data cursors visible**.

If you want to hide all selected data cursors in the Channel Plot window at once, select the **Multi-channel Actions** button (  **Actions** ▼ ), and choose **Selected data cursors hidden**.

## Showing or Hiding the Show Cursor Column

If you wish, you can change whether the **Show Cursor** column is shown or hidden by selecting the **Hide/show columns** (  ) button, and selecting **Show Cursor**. A checkmark means the column is shown; no checkmark means the column is hidden.

## Moving the Show Cursor Column

If you wish, you can move the position of the **Show Cursor** column by clicking the left-mouse button to select it, dragging it to the right or left, and letting go of the left-mouse button.

## Specifying the Columns of the Channel Plot Window

You can determine how many columns are displayed in the Channel Plot window by using the following controls in the Plot and Data Config window:

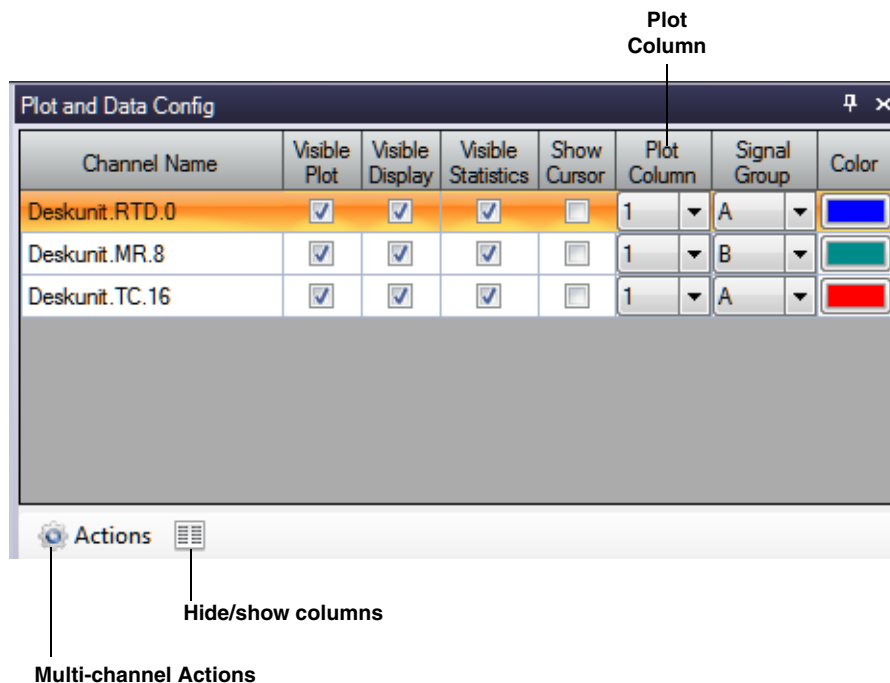

You can specify up to six columns to view in the Channel Plot window.

Under **Plot Column**, select the column (1 to 6) in which to display the selected channel. The following example shows a display of two plot columns, where the thermocouple channels are displayed in column 1 and voltage channels are displayed in column 2:

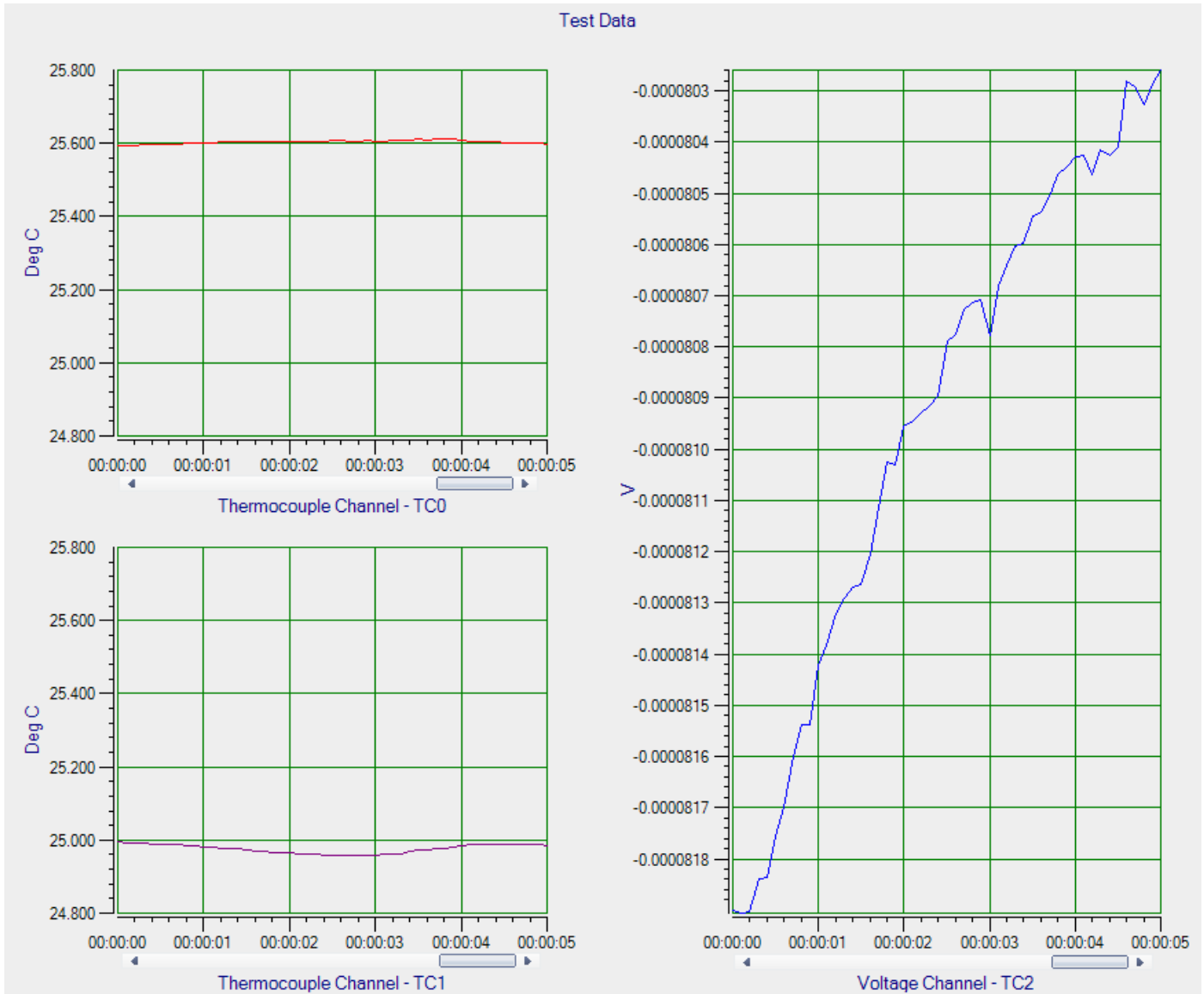

### Changing the Plot Column for All Selected Channels at Once

If you want to change the plot column for all selected channels at once, do the following:

1. Highlight the channels in the Plot and Data Config window that you want to change.
2. Select the **Multi-channel Actions** button (  **Actions** ▾ ).
3. Choose **Selected channels Plot Column**.
4. Enter the number of plot columns to use.

## Showing or Hiding the Plot Column

If you wish, you can change whether the **Plot Column** is shown or hidden by selecting the **Hide/show columns** (  ) button, and selecting **Plot Column**. A checkmark means the column is shown; no checkmark means the column is hidden.

## Moving the Plot Column

If you wish, you can move the position of the **Plot Column** by clicking the left-mouse button to select it, dragging it to the right or left, and letting go of the left-mouse button.

## Grouping Signals in Bands on the Channel Plot Window

You can group signals in bands in the Channel Plot window by using the following controls in the Plot and Data Config window:

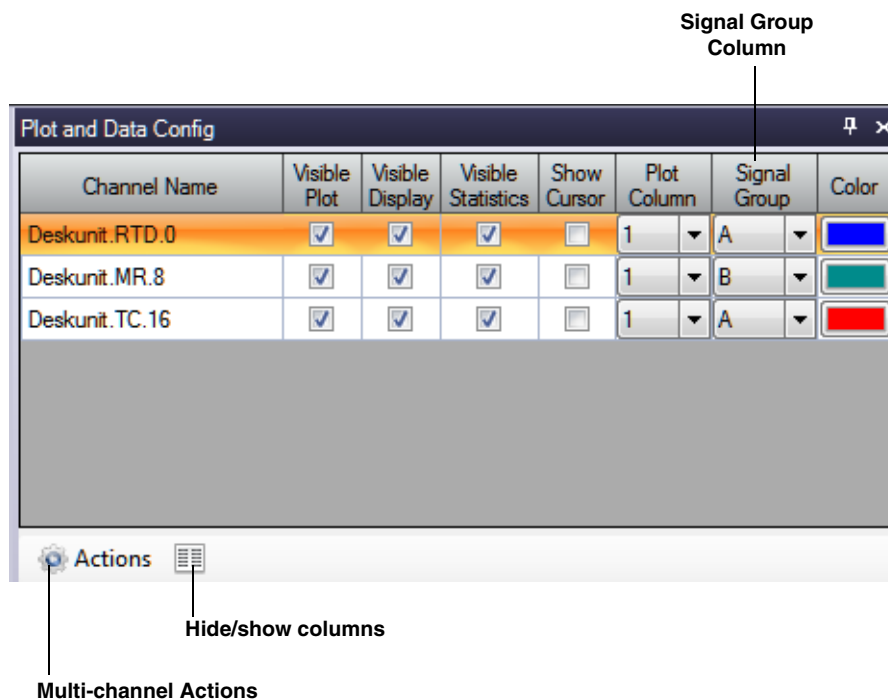

You can choose to display multiple signals in the same band by assigning the same **Signal Group** letter to them. You can specify a value of **A** through **T** for the Signal Group.

For example, to see the data from analog input signals 1 and 2 in the same band, you could set the **Signal Group** for both channels to **A**.

If two analog input channels have a different plot data type (for example, one is temperature and the other is voltage), two Y-axes are displayed for the band, as shown in the following example:





### ***Changing the Signal Group for All Selected Channels at Once***

If you want to change the value of the signal group for all selected channels at once, do the following:

1. Highlight the channels in the Plot and Data Config window that you want to change.
2. Select the **Multi-channel Actions** button (  **Actions** ▾ ).
3. Choose **Selected channels Signal Group**.
4. Enter the value of the signal band to use.

### ***Showing or Hiding the Signal Group Column***

If you wish, you can change whether the **Signal Group** column is shown or hidden by selecting the **Hide/show columns** (  ) button, and selecting **Signal Group**. A checkmark means the column is shown; no checkmark means the column is hidden.

### ***Moving the Signal Group Column***

If you wish, you can move the position of the **Signal Group** column by clicking the left-mouse button to select it, dragging it to the right or left, and letting go of the left-mouse button.

## Specifying the Trace Color on the Channel Plot Window

You can specify the color of the trace on the Channel Plot window by using the following controls in the Plot and Data Config window:

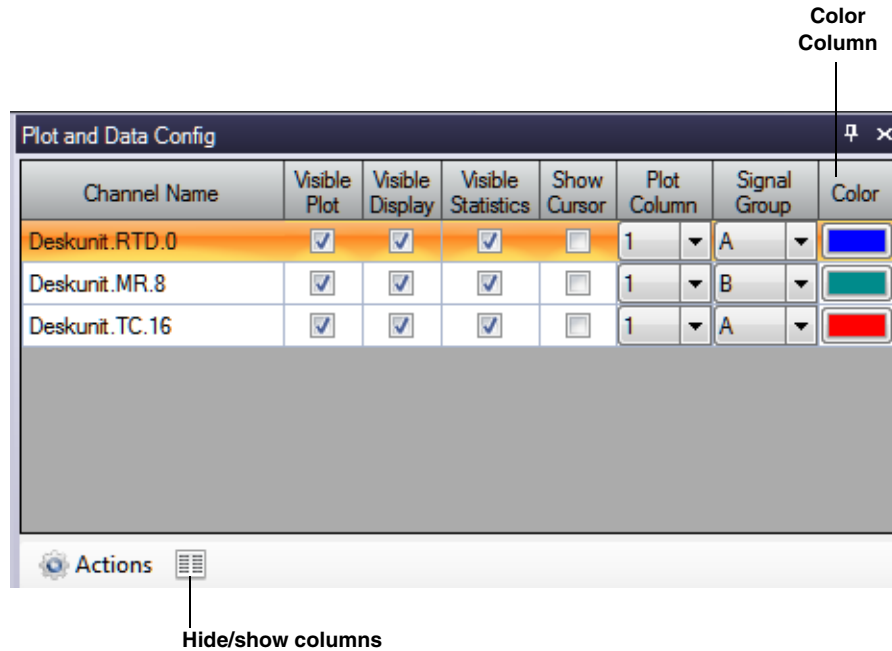

For each channel, select the **Color** column, and then select the color that you want to display for the trace in the Channel Plot window.

### Showing or Hiding the Color Column

If you wish, you can change whether the **Color** column is shown or hidden by selecting the **Hide/show columns** (  ) button, and selecting **Color**. A checkmark means the column is shown; no checkmark means the column is hidden.

### Moving the Color Column

If you wish, you can move the position of the **Color** column by clicking the left-mouse button to select it, dragging it to the right or left, and letting go of the left-mouse button.

## Controlling How Data is Plotted in the Channel Plot Window

Using the Channel Plot Control tab in the Plot and Data Config window, you can control how data is plotted in the Channel Plot window.

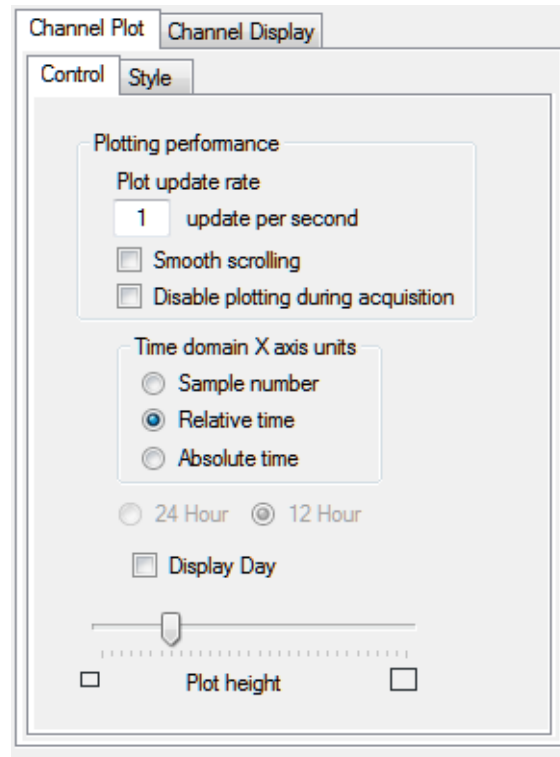

You can configure the following settings:

- **Plot update rate**, – Enter a value between 1 and 50 to indicate how often you want the display to be refreshed per second.
- **Smooth scrolling** – You can adjust how the plot scrolls to the left using the **Smooth scrolling** checkbox. If **Smooth scrolling** is checked, the plot attempts to scroll after each data point is added. However, scrolling is limited by the actual update rate. For example, if the **Plot update rate** is set to 50, and 100 points are added per second (determined by the **Recording** settings), the plot scrolls to the left by 2 samples, 50 times per second.

If the **Smooth scrolling** checkbox is unchecked, the plot does not attempt to scroll after every point is added; instead, it scrolls after each buffer is plotted. The buffer size is set to the FFT size.

- **Disable plotting during acquisition** – This checkbox is provided for fast data acquisition boards, such as the DT9832, which acquire data faster than the application can display it.

If the **Disable plotting during acquisition** checkbox is checked, no data is displayed in the Channel Plot window during acquisition. When acquisition is finished, the data is displayed in the Channel Plot window.

If the **Disable plotting during acquisition** checkbox is unchecked, the data is displayed in the Channel Plot window as the data is acquired.

- Under **Time domain X axis units**, select the units for the x-axis as one of the following:
  - **Sample number** – The units for the x-axis are represented as the number of samples (0 to the maximum number of samples acquired).
  - **Relative time** – The units for the x-axis are represented as the recording time from 0 to the total recording time.
  - **Absolute time** – The units for the x-axis are represented as the actual time of acquisition based on the system clock. If you select absolute time, you can select whether to represent the time in 24-hour (military) format or 12-hour format.
- **Display Day** – If **Absolute Time** is selected and you check the **Display Day** checkbox, the x-axis shows dd:hh:mm:ss, where *dd* is the day of the month, *hh* is hours, *mm* is minutes, and *ss* is seconds. If **Relative Time** is selected, the value for day starts at 0 and increments by one for each subsequent day. You can also set the value for day in the x-axis options if the **Display Day** checkbox is selected.

---

**Note:** You can change the resolution or precision of the x-axis, as described on [page 71](#).

---

- Use the **Plot height** slider bar, to determine the relative height of each plot in the Channel Plot window. Slide the control to the right to increase the height; slide the control to the left to decrease the height. Note that the entire screen is always filled, so, typically, this setting is useful when you want to view many plots at once.

## Specifying the Style of the Plots in the Channel Plot Window

The Channel Plot Style tab allows you to specify the style of the plots that are displayed in the Channel Plot window.

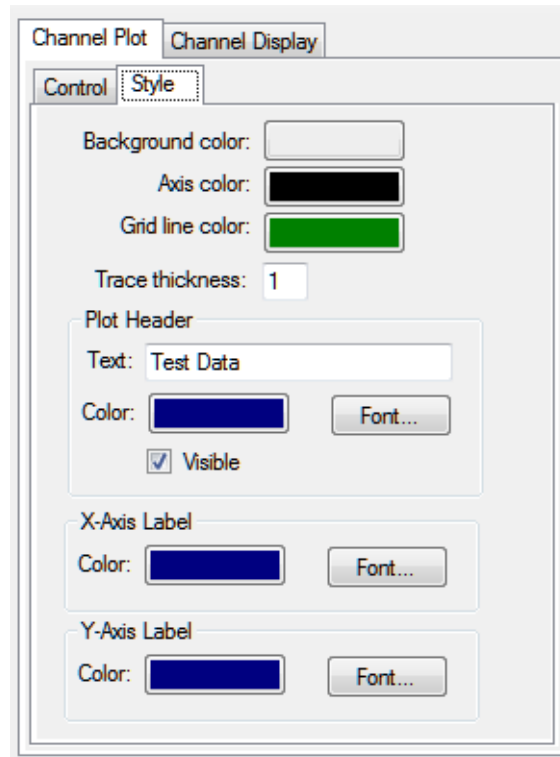

You can configure the following settings:

- Use the **Background Color** box to choose a different color for the background of the Channel Plot window.
- Use the **Axis color** box to choose a different color for the axes of the Channel Plot window.
- Use the **Grid line color** box to choose a different color for the grid lines of the Channel Plot window.
- In the **Trace thickness** box, enter the value between 1 and 5 to set the thickness of the line used by the trace on the Channel Plot window, where 1 is the thinnest line and 5 is the thickest line.
- Under **Plot Header**, click the **Visible** checkbox if you want a header displayed for the data on the plot, and then enter the text for the header. By default, the header is called *Test Data*. You can also select the color for the header and the font in which to display the header.
- Under **X-Axis Label**, you can select the color for the label of the x-axis and the font in which to display the x-axis label.
- Under **Y-Axis Label**, you can select the color for the label of the y-axis and the font in which to display the y-axis label.

## Configuring the Appearance of the Channel Display Window

This section describes the how to configure the appearance of the Channel Display window, when using the Data Logger interface, and includes the following topics:

- Displaying channels in the Channel Display window, described on this page
- Controlling how data is displayed in the Channel Display window, described on [page 184](#)
- Specifying the style of the Channel Display window, described on [page 186](#)

### Displaying Channels in the Channel Display Window

You can determine which channels are displayed in the Channel Display window by using the following controls in the Plot and Data Config window:

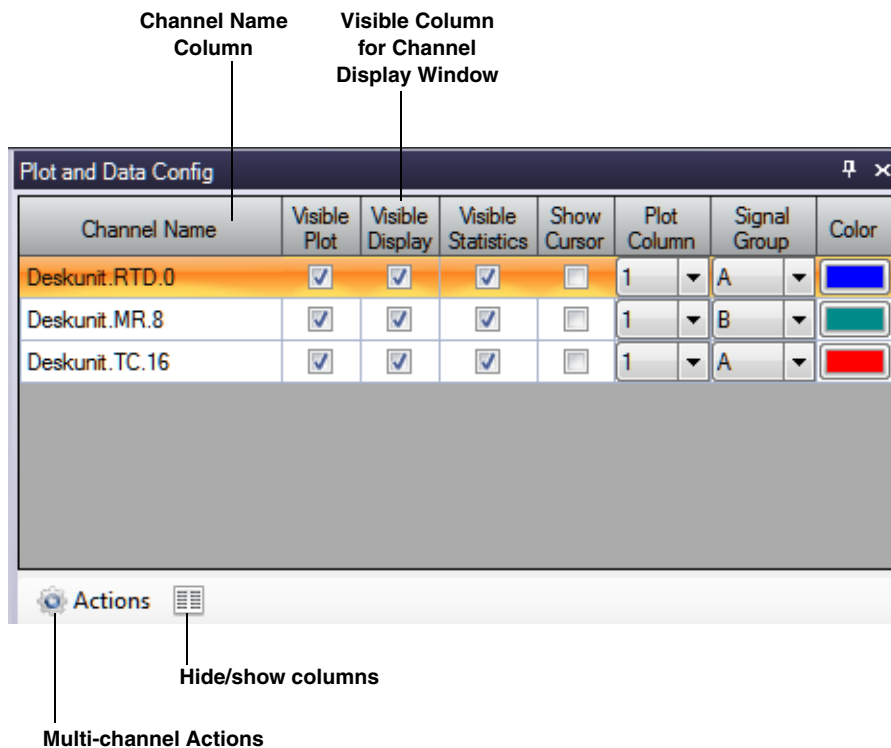

You can see the names of all enabled channels under the **Channel Name** column in the Plot and Data Config window. Only data from the list of enabled channels is acquired.

---

**Note:** If desired, you can change the name of a channel using the **Input Channel Configuration** menu option, described on [page 86](#).

---

For each enabled channel, you can control which channels are displayed in the Channel Display window using the **Visible Display** checkbox. If a box is checked under the **Visible Display** column, the data for the associated channel is displayed in the Channel Display window. If a box under the **Visible Display** column is unchecked, the data for the associated channel is not displayed in the Channel Display window.

---

**Note:** Data for all enabled channels is recorded regardless of whether the channel is visible.

---

### ***Making All Selected Channels Visible or Hidden in the Channel Display Window at Once***

If you want to make all selected channels visible in the Channel Display window at once, select the **Multi-channel Actions** button (  **Actions** ▾ ), and choose **Selected channels visible in Channel Display**.

If you want to hide all selected channels in the Channel Display window at once, select the **Multi-channel Actions** button (  **Actions** ▾ ), and choose **Selected channels hidden in Channel Display**.

### ***Showing or Hiding the Visible Display Column***

If you wish, you can change whether the **Visible Display** column is shown or hidden by selecting the **Hide/show columns** (  ) button, and selecting **Visible Display**. A checkmark means the column is shown; no checkmark means the column is hidden.

### ***Moving the Visible Display Column***

If you wish, you can move the position of the **Visible Display** column by clicking the left-mouse button to select it, dragging it to the right or left, and letting go of the left-mouse button.

## Controlling How Data is Displayed in the Channel Display Window

Using the **Channel Display - Control** tab in the Plot and Data Config window, you can control how data is displayed in the Channel Display window.

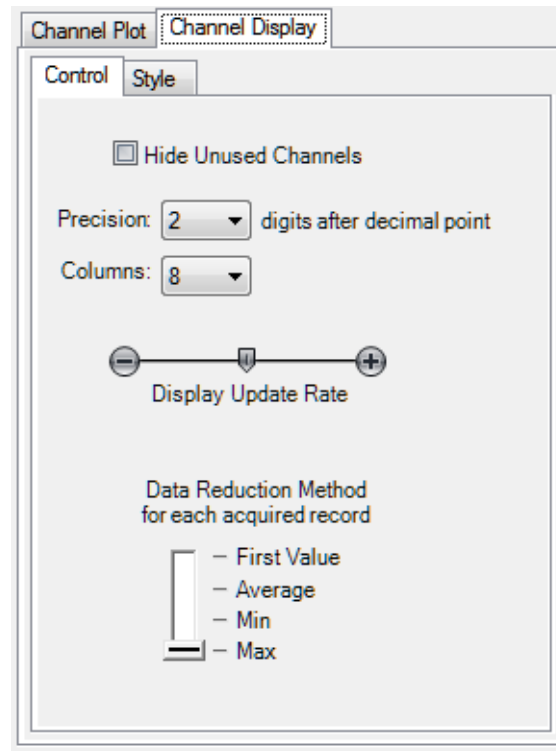

You can configure the following settings:

- **Hide Unused Channels** – By default, the Channel Display window resembles the front panel of the device and shows up to 48 channels. However, if you want your display to show only the enabled channels rather than all the channels, check the **Hide Unused Channels** box. The following example illustrates how the display looks when three channels are enabled and the **Hide Unused Channels** box is checked.

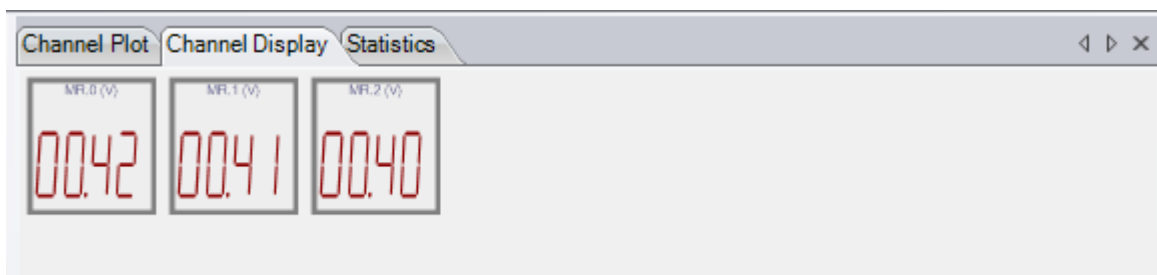

- **Precision** – You can select the number of significant digits after the decimal point to display; values range from 1 to 8 (2 is the default).



- **Columns** – You can specify how many columns to use when displaying the channels; values range from 1 to 16 (8 is the default). For example, by choosing 1, shown below, you can display each channel, one on top of the other (note that the lowest numbered channel is always at the bottom of the display and the highest numbered channel is at the top of the display):



- **Display Update Rate** – You can choose how fast you want the display of the Channel Display window to be updated. Slide the bar to the left for faster update rates, or slide the bar to the right for slower update rates.
- **Data Reduction Method** – You can choose which value to display in the Channel Display window:
  - **First Value** – The first value in the most recent buffer is displayed for each channel.
  - **Average** – The average value in the most recent buffer is displayed for each channel.
  - **Min** – The minimum value in the most recent buffer is displayed for each channel.
  - **Max** – The maximum value in the most recent buffer is displayed for each channel.

## Specifying the Style of the Channel Display Window

Using the Channel Display Style tab, you can specify the style of the Channel Display window.

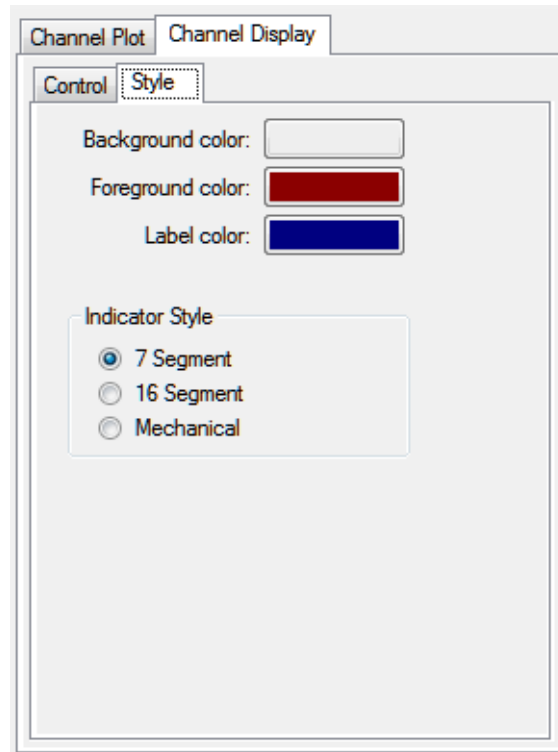

You can configure the following parameters:

- **Background color** – Allows you to choose a specific color for the background of the Channel Display window. You can select from a number of predefined colors or you can define your own color for the background.
- **Foreground color** – Allows you to choose a specific color for the foreground of the Channel Display window. You can select from a number of predefined colors or you can define your own color for the foreground.
- **Label color** – Allows you to choose a specific color for the label used on the Channel Display window. You can select from a number of predefined colors or you can define your own color for the label.

- **Indicator style** – Allows you to specify how the numbers and letters that represent the data appear. The following choices are available:
  - **7 Segment** – The numbers and letters that represent the data are composed of 7-segment lines.

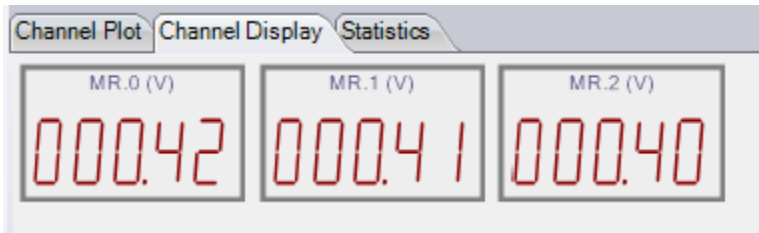

- **16 Segment** – The numbers and letters that represent the data are composed of 16-segment lines.

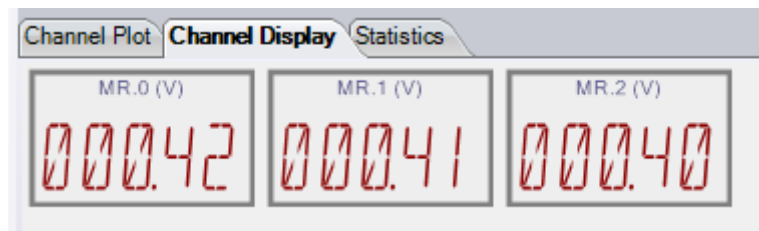

- **Mechanical** – The numbers and letters that represent the data appear to be formed by a contiguous line.

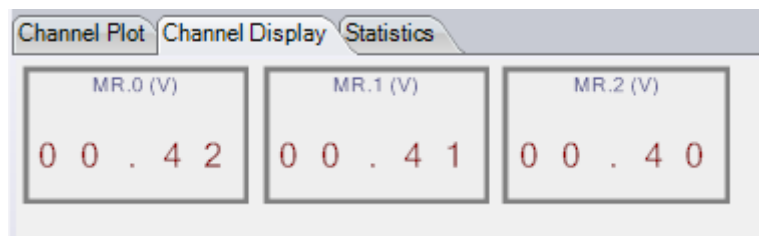

## Configuring the Appearance of the Statistics Window

You can determine whether statistics are displayed in the Statistics window by using the following controls in the Plot and Data Config window:

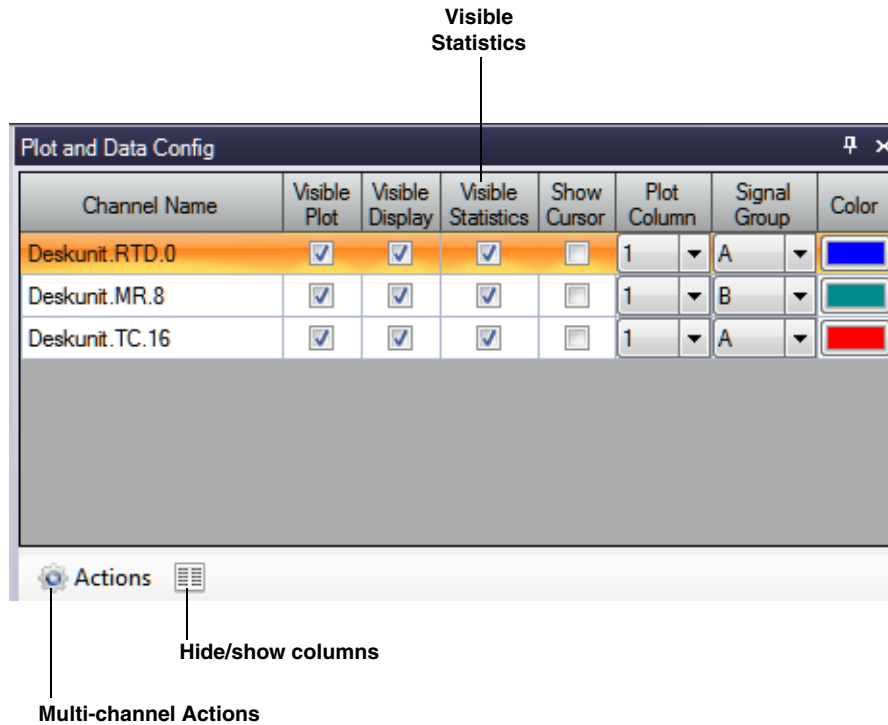

For each enabled channel listed under the **Channel Name** column, you can control whether statistics are displayed in the Statistics window using the **Visible Statistics** checkbox. If a box is checked under the **Visible Statistics** column, the statistics for the associated channel are listed in the Statistics window. If a box under the **Visible Statistics** column is unchecked, the statistics for the associated channel are not displayed in the Statistics window.

### Making Statistics for All Selected Channels Visible or Hidden in the Statistics Window at Once

If you want to make statistics for all selected channels visible in the Statistics window at once, select the **Multi-channel Actions** button (  **Actions** ▾ ), and choose **Selected channels visible in Statistics Display**.

If you want to hide statistics for all selected channels in the Statistics window at once, select the **Multi-channel Actions** button (  **Actions** ▾ ), and choose **Selected channels hidden in Statistics Display**.

## Showing or Hiding the Visible Statistics Column

If you wish, you can change whether the **Visible Statistics** column is shown or hidden by selecting the **Hide/show columns** (  ) button, and selecting **Visible Statistics**. A checkmark means the column is shown; no checkmark means the column is hidden.

## Moving the Visible Statistics Column

If you wish, you can move the position of the **Visible Statistics** column by clicking the left-mouse button to select it, dragging it to the right or left, and letting go of the left-mouse button.





# ***Configuring the Display of the FFT Analyzer Interface***

Introduction.....	192
Configuring the Appearance of the Channel Plot Window.....	193
Adding Channels to the Plot and Data Config Window.....	204
Removing Channels from the Plot and Data Config Window.....	208
Configuring Parameters for a Single FFT Channel.....	209
Configuring Parameters for a Two-Channel FRF Function.....	215
Configuring Parameters for a Two-Channel Cross Spectrum Function.....	220
Configuring Parameters for a Two-Channel Coherence Function.....	224
Configuring Statistics for FFT Plots Using the Stats Tab.....	227
Scrolling through FFTs for an Analog Input Channel.....	229
Configuring the Appearance of the Channel Display Window.....	230
Configuring the Appearance of the Statistics Window.....	236

## ***Introduction***

This chapter describes how to configure the display when using the FFT Analyzer interface. If you are using the Data Logger interface, refer to [Chapter 5 starting on page 169](#).



## Configuring the Appearance of the Channel Plot Window

This section describes the following aspects related to the appearance of the Channel Plot window when using the FFT Analyzer interface:

- Displaying channels in the Channel Plot window, described on this page
- Displaying data cursors in the Channel Plot window, described on [page 195](#)
- Specifying the columns of the Channel Plot window, described on [page 196](#)
- Grouping signals in bands on the Channel Plot window, described on [page 198](#)
- Specifying the trace color on the Channel Plot window, described on [page 200](#)
- Controlling how data is plotted the Channel Plot window, described on [page 201](#)
- Controlling the style of the plots in the Channel Plot window, described on [page 202](#)

### Displaying Channels in the Channel Plot Window

You can determine which channels are displayed in the Channel Plot window by using the following controls in the Plot and Data Config window:

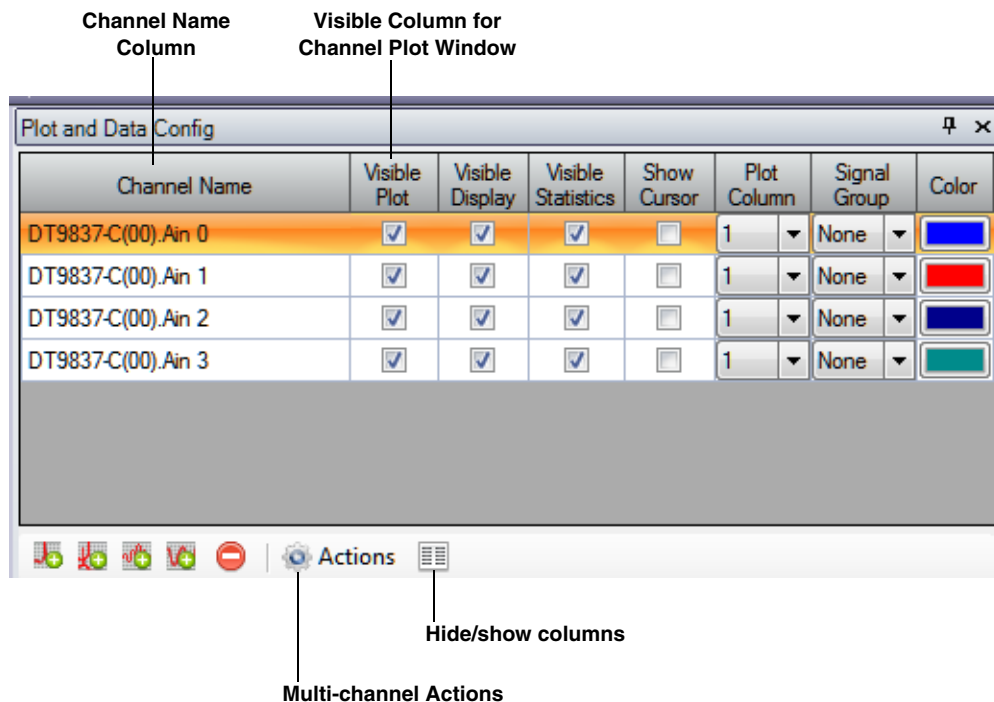

You can see the names of all enabled channels under the **Channel Name** column in the Plot and Data Config window. Only data from the list of enabled channels is acquired.

---

**Note:** If desired, you can change the name of a channel using the **Input Channel Configuration** menu option or toolbar button, described on [page 90](#).

---

For each enabled channel listed under the **Channel Name** column, you can control which channels are displayed in the Channel Plot window using the **Visible Plot** checkbox. If a box is checked under the **Visible Plot** column, a plot for the associated channel is displayed in the Channel Plot window. If a box under the **Visible Plot** column is unchecked, the plot for the associated channel is not displayed in the Channel Plot window.

---

**Note:** Data for all enabled channels is recorded regardless of whether the channel is visible.

---

### ***Making All Selected Channels Visible or Hidden in the Channel Plot Window at Once***

If you want to make all selected channels visible in the Channel Plot window at once, select the **Multi-channel Actions** button (  **Actions** ), and choose **Selected channels visible in Channel Plot**.

If you want to hide all selected channels in the Channel Plot window at once, select the **Multi-channel Actions** button (  **Actions** ), and choose **Selected channels hidden in Channel Plot**.

### ***Showing or Hiding the Visible Plot Column***

If you wish, you can change whether the **Visible Plot** column is shown or hidden by selecting the **Hide/show columns** (  ) button, and selecting **Visible Plot**. A checkmark means the column is shown; no checkmark means the column is hidden.

### ***Moving the Visible Plot Column***

If you wish, you can move the position of the **Visible Plot** column by clicking the left-mouse button to select it, dragging it to the right or left, and letting go of the left-mouse button.

## Displaying Data Cursors in the Channel Plot Window

You can determine whether data cursors are displayed in the Channel Plot window by using the following controls in the Plot and Data Config window:

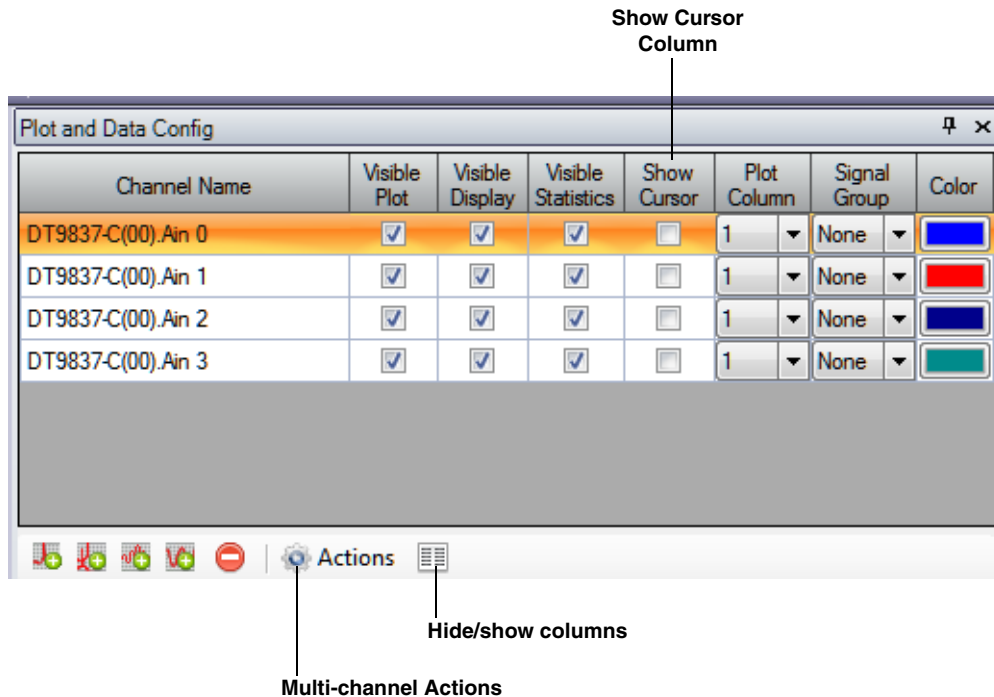

For each of the enabled channels, you can choose to display a data cursor in the Channel Plot window using the **Show Cursor** column in the Plot and Data Config window.

If a box is checked under the **Show Cursor** column, a data cursor for the associated channel is displayed in the Channel Plot window. If a box under the **Show Cursor** column is unchecked, a data cursor for the associated channel is not displayed in the Channel Plot window.

You can enable the capability of moving the data cursor using the data-cursor control (  ), described on [page 75](#). Various options are available for changing the cursor style, line style, and cursor color.

### ***Making All Selected Data Cursors Visible or Hidden at Once***

If you want to make all selected data cursors visible in the Channel Plot window at once, select the **Multi-channel Actions** button (  ), and choose **Selected data cursors visible**.

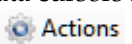
If you want to hide all selected data cursors in the Channel Plot window at once, select the **Multi-channel Actions** button (  ), and choose **Selected data cursors hidden**.

## Showing or Hiding the Show Cursor Column

If you wish, you can change whether the **Show Cursor** column is shown or hidden by selecting the **Hide/show columns** (  ) button, and selecting **Show Cursor**. A checkmark means the column is shown; no checkmark means the column is hidden.

## Moving the Show Cursor Column

If you wish, you can move the position of the **Show Cursor** column by clicking the left-mouse button to select it, dragging it to the right or left, and letting go of the left-mouse button.

## Specifying the Plot Columns of the Channel Plot Window

You can determine how many columns are displayed in the Channel Plot window by using the following controls in the Plot and Data Config window:

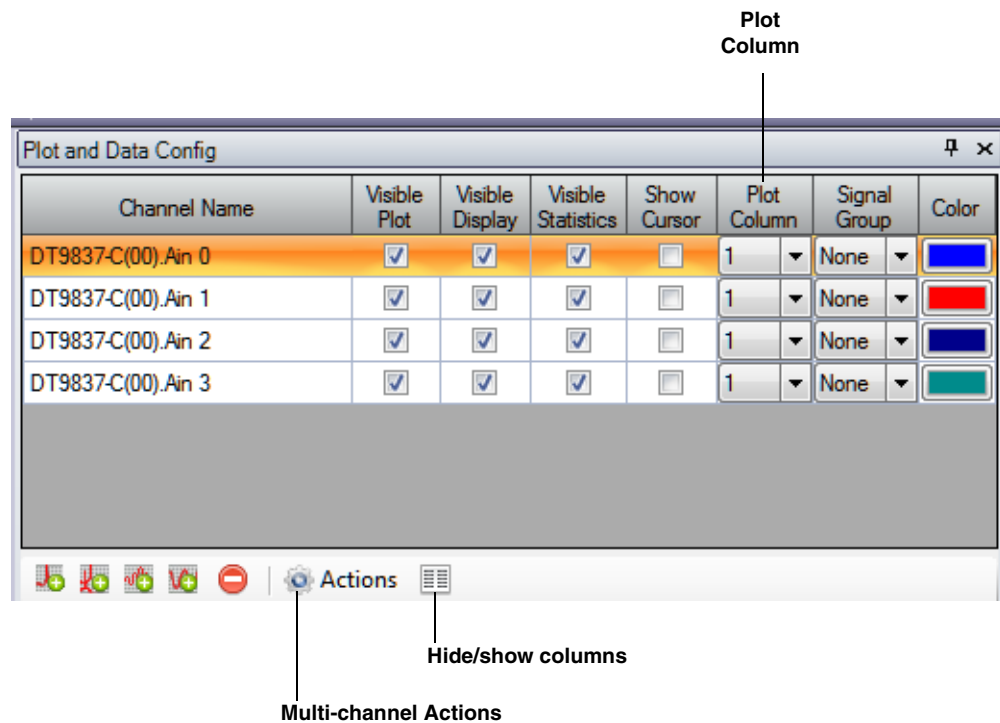

You can specify up to six columns to view in the Channel Plot window.

Under **Plot Column**, select the column (1 to 6) in which to display the selected channel. The following example shows a display of two plot columns, where the time domain channels are displayed in column 1 and the FFT channels are displayed in column 2:

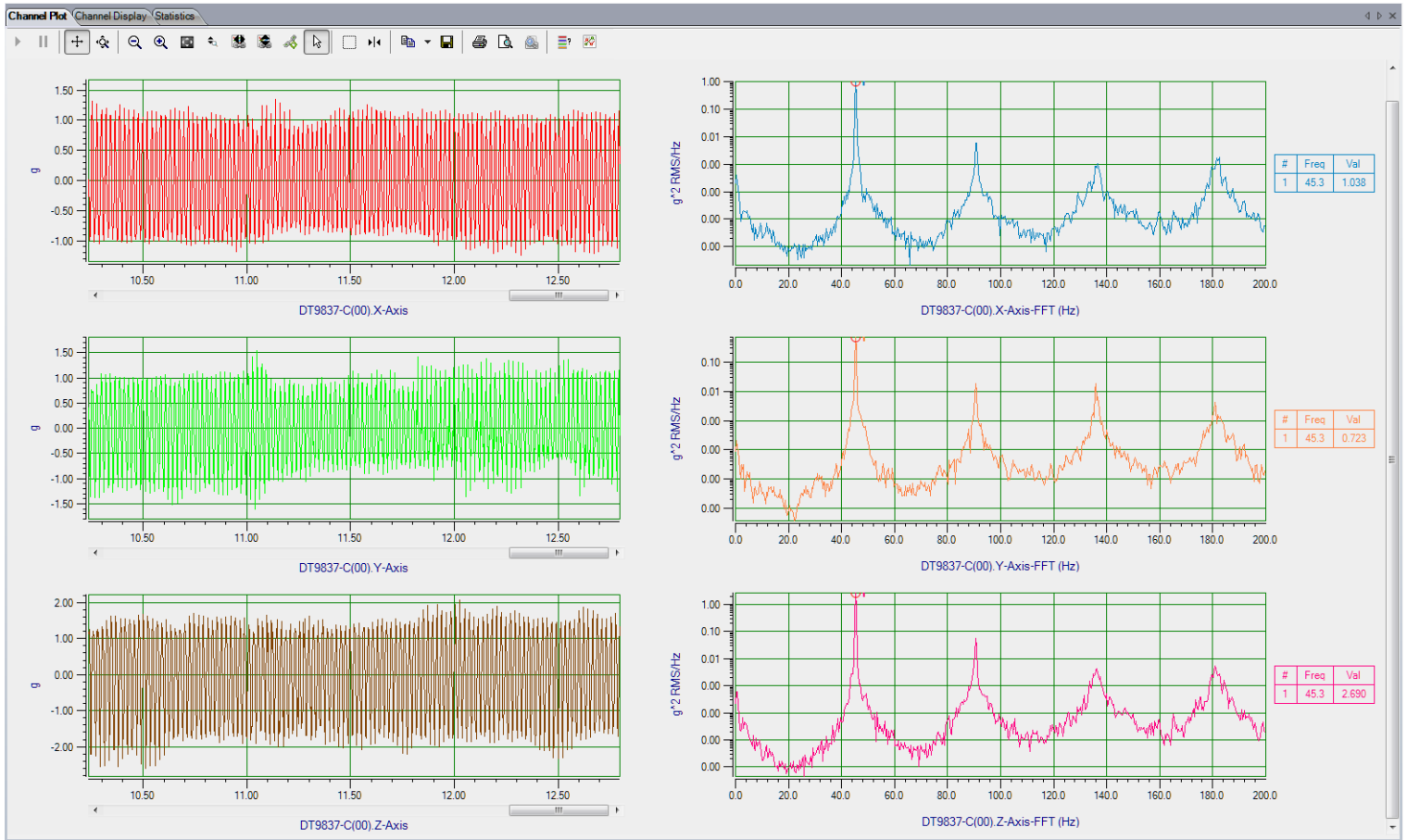

### Changing the Plot Column for All Selected Channels at Once

If you want to change the plot column for all selected channels at once, do the following:

1. Highlight the channels in the Plot and Data Config window that you want to change.
2. Select the **Multi-channel Actions** button (  **Actions** ).
3. Choose **Selected channels Plot Column**.
4. Enter the number of the plot column to use.

### Showing or Hiding the Plot Column

If you wish, you can change whether the **Plot Column** is shown or hidden by selecting the **Hide/show columns** (  ) button, and selecting **Plot Column**. A checkmark means the column is shown; no checkmark means the column is hidden.

### Moving the Plot Column

If you wish, you can move the position of the **Plot Column** by clicking the left-mouse button to select it, dragging it to the right or left, and letting go of the left-mouse button.

## Grouping Signals in Bands on the Channel Plot Window

You can group signals in bands in the Channel Plot window by using the following controls in the Plot and Data Config window:

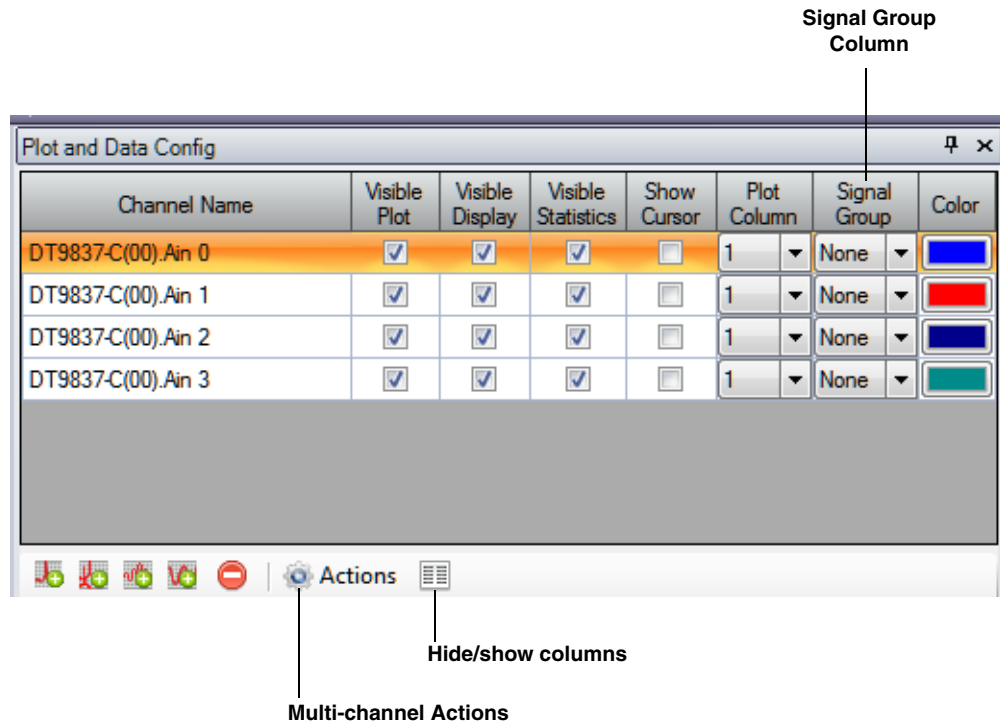

You can choose to display multiple signals in the same band by assigning the same **Signal Group** letter to them. You can specify a value of **A** through **T** for the Signal Group.

For example, to see the data from analog input signals 1 and 2 (in the time domain) in the same band, you could set the **Signal Group** for both channels to **A**.

If two analog input channels have a different plot data type (for example, one is voltage and the other is a sensor), two Y-axes are displayed for the band, as shown in the following example:

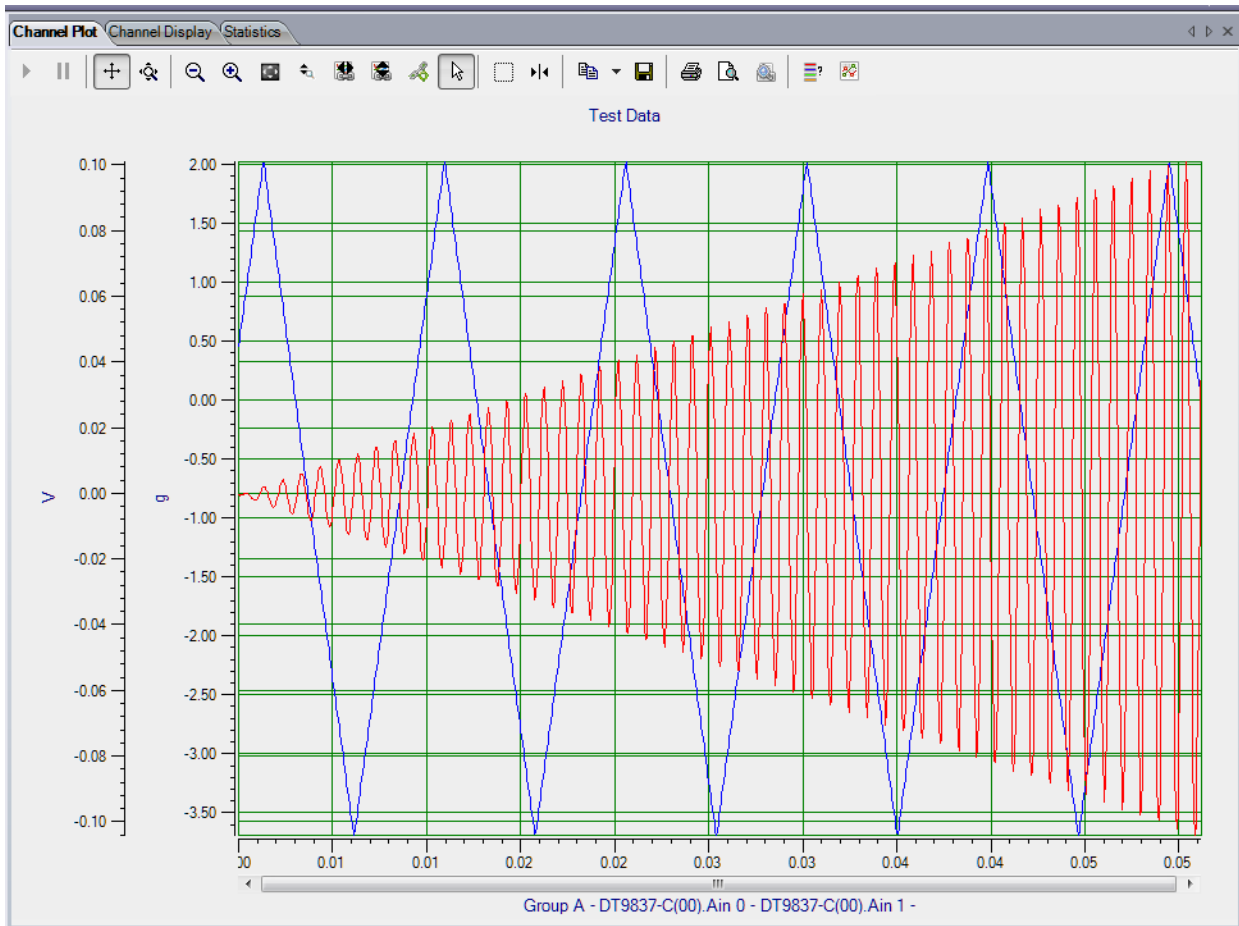

Likewise, if two FFT channels have different parameters, two y-axis are displayed for the band.

Note that the **Signal Group** letter is shown in the legend beneath the x-axis.

### ***Changing the Signal Group for All Selected Channels at Once***

If you want to change the value of the signal group for all selected channels at once, do the following:

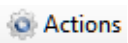
1. Highlight the channels in the Plot and Data Config window that you want to change.
2. Select the **Multi-channel Actions** button (  ).
3. Choose **Selected channels Signal Group**.
4. Enter the value of the signal band to use.

### ***Showing or Hiding the Signal Group Column***

If you wish, you can change whether the **Signal Group** column is shown or hidden by selecting the **Hide/show columns** (  ) button, and selecting **Signal Group**. A checkmark means the column is shown; no checkmark means the column is hidden.

## Moving the Signal Group Column

If you wish, you can move the position of the **Signal Group** column by clicking the left-mouse button to select it, dragging it to the right or left, and letting go of the left-mouse button.

## Specifying the Trace Color on the Channel Plot Window

You can specify the color of the trace on the Channel Plot window by using the following controls in the Plot and Data Config window:

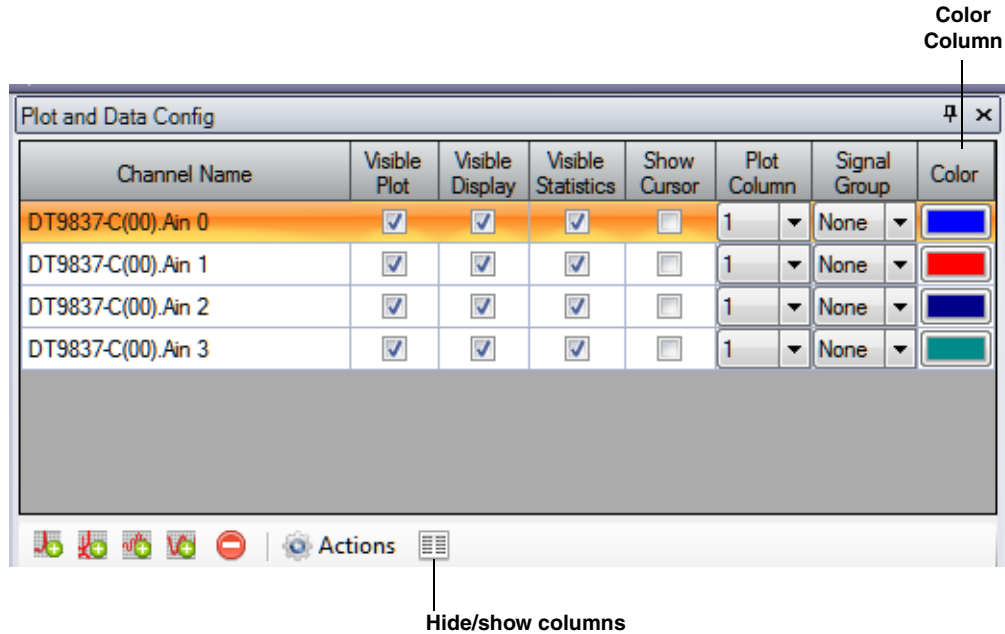

For each channel, select the **Color** column, and then select the color that you want to display for the trace in the Channel Plot window.

## Showing or Hiding the Color Column

If you wish, you can change whether the **Color** column is shown or hidden by selecting the **Hide/show columns** (  ) button, and selecting **Color**. A checkmark means the column is shown; no checkmark means the column is hidden.

## Moving the Color Column

If you wish, you can move the position of the **Color** column by clicking the left-mouse button to select it, dragging it to the right or left, and letting go of the left-mouse button.



## Controlling How Data is Plotted in the Channel Plot Window

Using the Channel Plot Control tab in the Plot and Data Config window, you can control how data is plotted in the Channel Plot window.

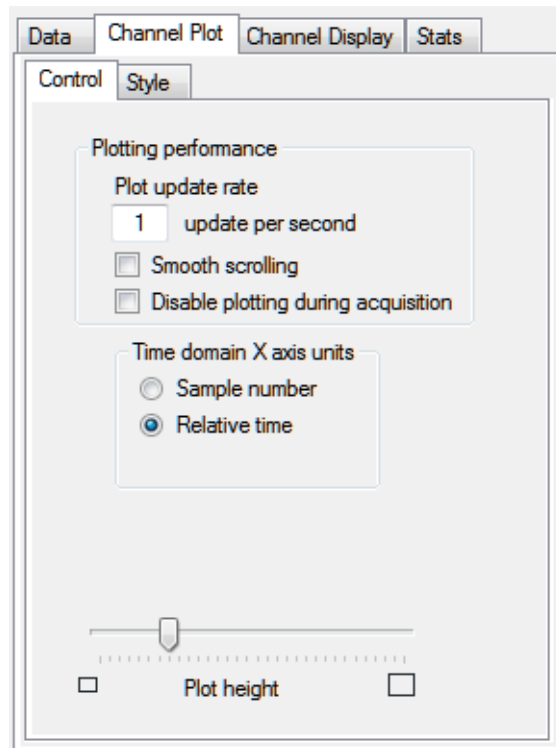

You can configure the following settings:

- **Plot update rate**, – Enter a value between 1 and 50 to indicate how often you want the display to be refreshed per second.
- **Smooth scrolling** – You can adjust how the plot scrolls to the left using the **Smooth scrolling** checkbox. If **Smooth scrolling** is checked, the plot attempts to scroll after each data point is added. However, scrolling is limited by the actual update rate. For example, if the **Plot update rate** is set to 50, and 100 points are added per second (determined by the **Recording** settings), the plot scrolls to the left by 2 samples, 50 times per second.

If the **Smooth scrolling** checkbox is unchecked, the plot does not attempt to scroll after every point is added; instead, it scrolls after each buffer is plotted. The buffer size is set to the FFT size.

- **Disable plotting during acquisition**, – You can determine whether the Channel Plot display updates during acquisition using the **Disable plotting during acquisition** checkbox. When checked, the Channel Plot display is updated only after acquisition has stopped. When unchecked, the Channel Plot display during acquisition.
- Under **Time domain X axis units**, select the units for the x-axis as either the number of samples (0 to the maximum number of samples acquired) or the relative time (0 to the total recording time).

- Use the **Plot height** slider bar, to determine the relative height of each plot in the view. Slide the control to the right to increase the height; slide the control to the left to decrease the height. Note that the entire screen is always filled, so, typically, this setting is useful when you want to view many plots at once.

## Specifying the Style of the Plots in the Channel Plot Window

The Channel Plot Style tab allows you to specify the style of the plots that are displayed in the Channel Plot window.

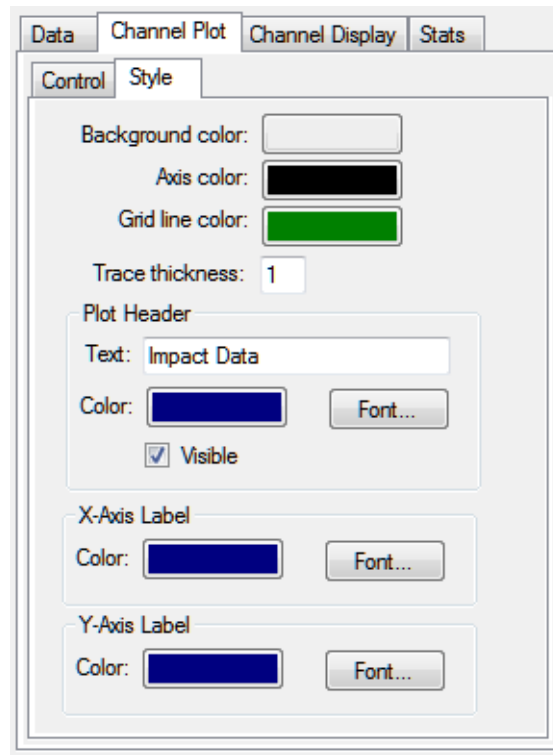

You can configure the following settings:

- Use the **Background Color** box to choose a different color for the background of the Channel Plot window.
- Use the **Axis color** box to choose a different color for the axes of the Channel Plot window.
- Use the **Grid line color** box to choose a different color for the grid lines of the Channel Plot window.
- In the **Trace thickness** box, enter the value between 1 and 5 to set the thickness of the line used by the trace on the Channel Plot window, where 1 is the thinnest line and 5 is the thickest line.
- Under **Plot Header**, click the **Visible** checkbox if you want a header displayed for the data on the plot, and then enter the text for the header. By default, the header is called *Test Data*. You can also select the color for the header and the font in which to display the header.

- Under **X-Axis Label**, you can select the color for the label of the x-axis and the font in which to display the x-axis label.
- Under **Y-Axis Label**, you can select the color for the label of the y-axis and the font in which to display the y-axis label.

## Adding Channels to the Plot and Data Config Window

If you are using the FFT Analyzer interface, buttons are provided under the channel selection area of the Plot and Data Config window to add channels to the Plot and Data Config window.

If you are using the FFT Analysis option of QuickDAQ, you can add a single FFT channel, a windowed time domain channel, or a time domain channel to the Plot and Data Config window, as shown in [Figure 33](#).

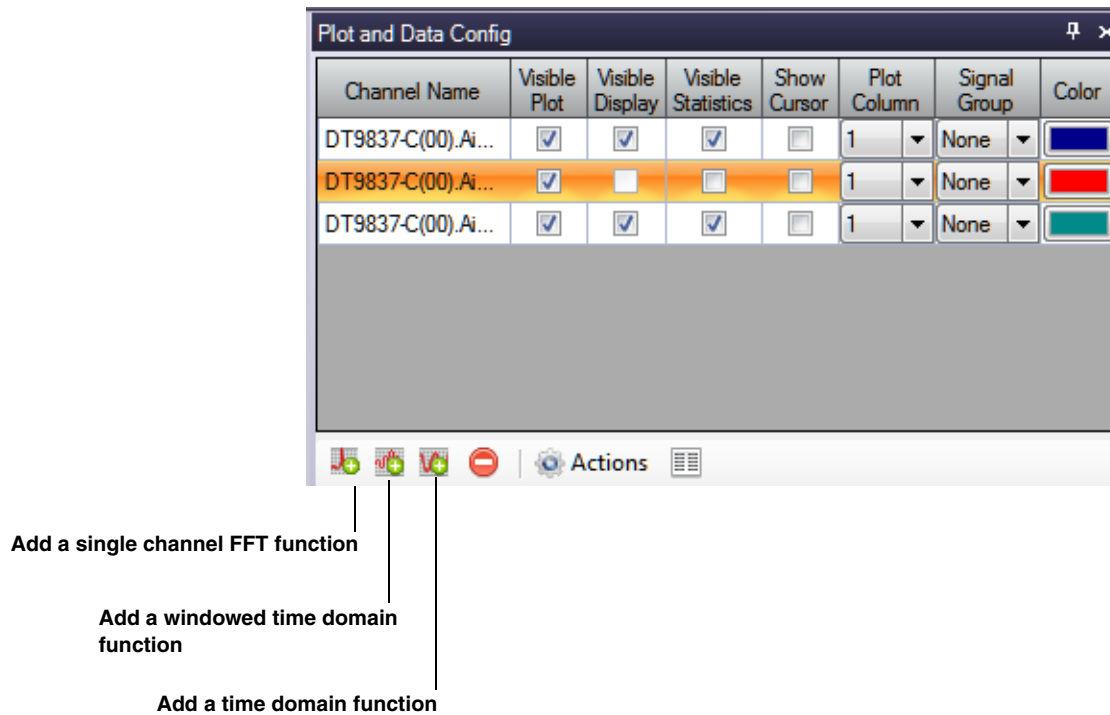

**Figure 33: Buttons for Adding Channels in the FFT Analysis Option**

If you are using the Advanced FFT Analysis option of QuickDAQ, you can add a single FFT channel, a two-channel FFT function, a windowed time domain channel, or a time domain channel to the Plot and Data Config window, as shown in [Figure 34](#).

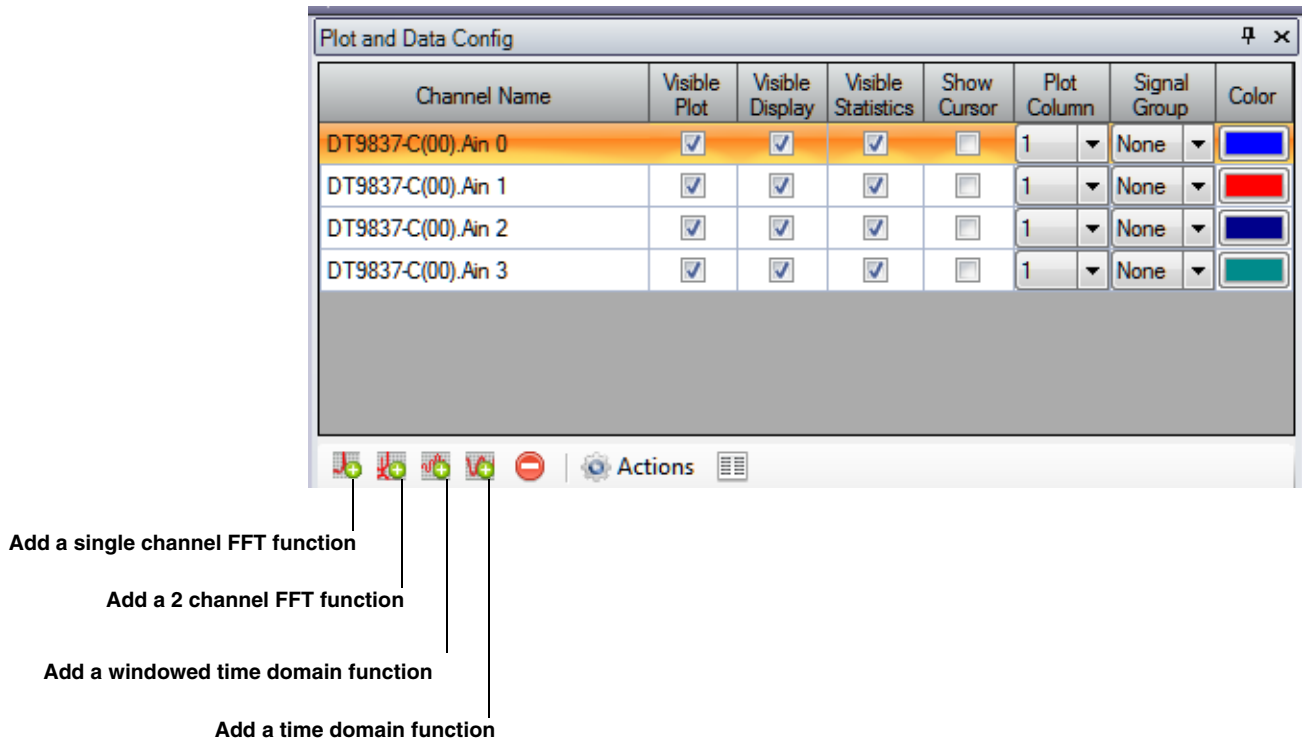

**Figure 34: Buttons for Adding Channels in the Advanced FFT Analysis Option**

The following subsections describe how to add channel to the Plot and Data Config window.

## Adding a Single Channel FFT Function to the Channel List

If you want to add a single channel FFT function to the list of channels shown under **Channel Name**, click the **Add single channel FFT function** (  ) button. Then, choose the analog input channel for which to generate the FFT.

Refer to [page 209](#) for information on configuring the FFT channel once it is added.

## Adding a Two-Channel FFT Function to the Channel List

If you are using the Advanced FFT Analysis option of QuickDAQ, you can add two-channel FFT functions to the channel list. Two-channel FFT functions are particularly useful when you want to apply a stimulus to a device and compare the response of the device to a known signal.

Before you can add a two-channel FFT function, you must configure one analog input channel as a response channel (the channel to which the stimulus is applied), and another analog input channel as the reference channel (the channel to which the response channel is compared). Refer to [page 86](#) for more information about configuring channels.

To add a two-channel FFT function to the list of channels shown under **Channel Name**, click the **Add 2 channel FFT function** (  ) button. The following options are available:

- **FRF** – Choose this option to add a frequency response function (FRF) channel. A FRF channel represents the complex ratio between the output (response) signal and the input (reference) signal as a function of frequency.

When you select **FRF**, you must choose an enabled response channel to compare to the reference channel; the resultant FRF channel is created and listed in the channel list.

Refer to [page 215](#) for information on configuring a FRF channel once you have added it.

- **Cross Spectrum** – Choose this option if you want to add a Cross Spectrum channel. A cross spectrum channel contains a building block that is used in FRF and other more advanced functions.

When you select **Cross Spectrum**, you must choose an enabled response channel to compare to the reference channel; the resultant Cross Spectrum channel is created and listed in the channel list.

Refer to [page 220](#) for information on configuring a Cross Spectrum channel once you have added it.

- **Coherence** – Choose this option if you want to add a coherence channel. A Coherence function evaluates the linearity between the input (reference) signal and the output (response) signal at each frequency, and generates a value between 0.0 and 1.0, where 0 is consistently not linear and 1.0 is consistently linear.

When you select **Coherence**, you must choose an enabled response channel to compare to the reference channel; the resultant Coherence channel is created and listed in the channel list.

Refer to [page 224](#) for information on configuring a Coherence channel once you have added it.

## Adding a Windowed Time Domain Channel to the List

If you want to see the effect of a window on a time domain channel before doing any FFT processing on the data, click the **Add windowed time domain channel** (  ) button. Then, select the time domain channel to which to apply the window function and from the list of enabled channels. The resulting channel is added to the list of channels shown under **Channel Name**.

You select the window to apply to the channel using the **Window** tab of the Acquisition Config window, described on [page 137](#).

No additional configuration is required for a windowed time domain channel. Therefore, all the options under the **Data** tab are grayed out for windowed time domain channels.

## Adding a Time Domain Channel to the List

If you want to add a time domain channel to the list of channels shown under **Channel Name**, click the **Add time domain channel** (  ) button. Then, select a time domain channel to add from the list of enabled channels. The resulting channel is added to the list of channels shown under **Channel Name**.

No additional configuration is required for a time domain channel. Therefore, all the options under the **Data** tab are grayed out for time domain channels.

## Removing Channels from the Plot and Data Config Window

If you are using the FFT Analyzer interface, a button is provided under the channel selection area of the Plot and Data Config window to remove a channel from the Plot and Data Config window:

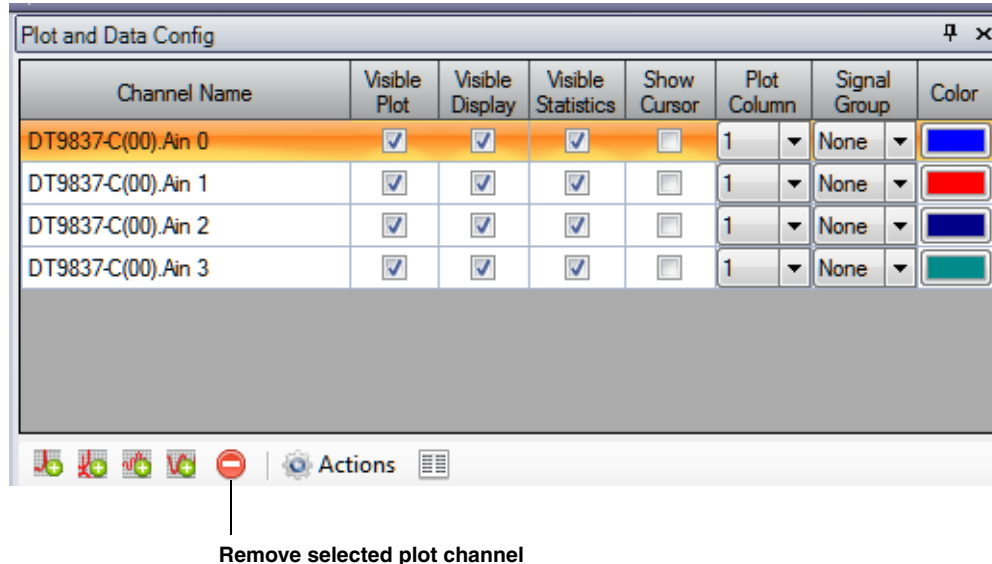

To remove a channel from the list of channels shown under **Channel Name**, click the **Remove selected plot channel** (  ) button, and then click **OK**.

Alternatively, you can select the channel from the list of channels shown under **Channel Name**, click the **Delete** key, and then click **OK** to remove the channel from the Plot and Data Config window.



## Configuring Parameters for a Single FFT Channel

If you are using the FFT Analyzer interface, you can add an FFT channel, if desired, as described on [page 205](#). Once you have selected an FFT channel under the **Channel Name** column, you can configure the parameters of the FFT channel using the **Data** tab options:

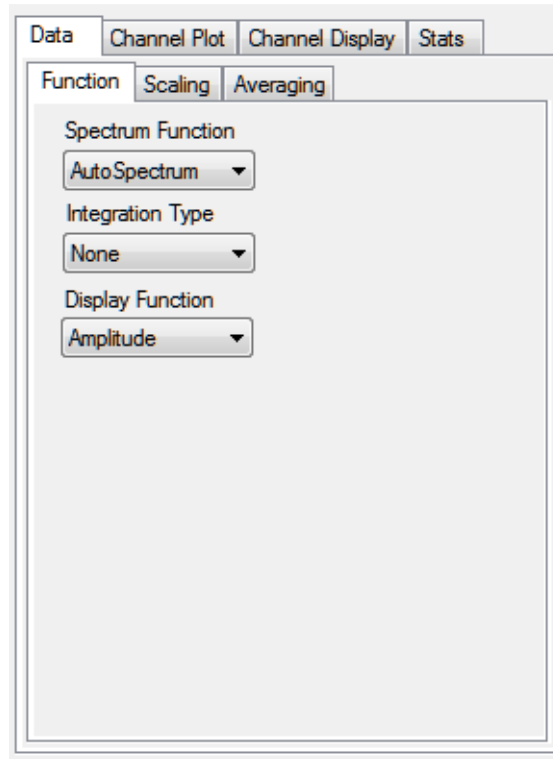

This section describes the options that appear under the **Data** tab if you select a single channel FFT channel in the Plot and Data Config window.

---

**Note:** Once you have acquired data, you can change the parameters under the **Data** tab and see the effect of your changes immediately by checking the **Auto-reprocess on parameter change** checkbox. Or, if this checkbox is not checked, click the **Apply settings to current data** button to see the results.

---

### Function Tab

The **Function** tab provides the following selections: **Spectrum Function**, **Integration Type**, and **Display Function**. These options are described in the following subsections.

## **Spectrum Function**

Under **Spectrum Function**, choose one of the following settings:

- **Spectrum** – Plots the magnitude of a periodic frequency component at a discrete frequency. It is computed as the square root of the average auto spectrum. For an accelerometer, for example, the units for **Spectrum** are represented as  $g$ . Typically, **Spectrum** is best for narrowband, deterministic signals.
- **Auto Spectrum** – Plots the power of a periodic frequency component at a discrete frequency. For an accelerometer, for example, the units for **Auto Spectrum** are represented as  $g^2$ . Typically, **Auto Spectrum** is best for narrowband, deterministic signals.
- **PSD** – (Power Spectral Density) Plots the power of random vibration intensity as “mean-square acceleration per frequency unit.” The spectrum is computed by squaring the magnitude of each frequency component in the FFT, and dividing this number by the change in frequency multiplied by the equivalent noise bandwidth of the windowing function. For an accelerometer, for example, the units for PSD are represented as  $g^2/Hz$ . Typically, **PSD** is best for wideband, continuous signals.

## **Integration Type**

Primarily used for accelerometer sensor types, choose one of the following integration types:

- **None** – No integration; acceleration data is represented as acceleration.
- **Single** – Data is integrated once; acceleration data is represented as velocity.
- **Double** – Data is integrated twice; acceleration data is represented as displacement.

## **Display Function**

If you are using the FFT Analysis option, the following settings are available for **Display Function**:

- **Amplitude** – Plots the length of the frequency response.
- **Phase** – Plots the frequency response phase shift (angle).

If you are using the Advanced FFT Analysis option of QuickDAQ, the following settings are available for **Display Function**:

- **Amplitude** – Plots the length of the frequency response.
- **Phase** – Plots the frequency response phase shift (angle).
- **Real** – Plots the real component of the complex resultant data on the y-axis against frequency on the x-axis.
- **Imaginary** – Plots the imaginary component of the complex resultant data on the y-axis against frequency on the x-axis.
- **Nyquist** – Plots the complex resultant data with the real components on the x-axis and imaginary components on the y-axis; the consecutive points are joined by line segments.

## Scaling Tab

The **Scaling** tab allows you specify how you want to scale the data for the FFT channel when it is plotted.

---

**Note:** This tab is not used if you select the Real, Imaginary, or Nyquist display function.

---

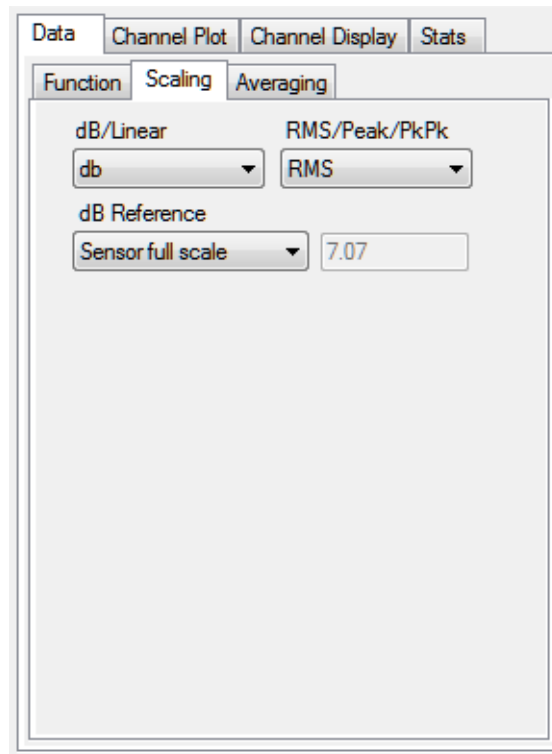

- **dB** or **Linear** – Select **dB** for decibels or **Linear** for the engineering units of the sensor, such as *g* for an accelerometer.

---

**Note:** If you select **Linear** scaling for the FFT channel, you can right-click on the axis of the plot, and select **Y Axis Setup** (for the y-axis) or **X Axis Setup** (for the x-axis) to change the scaling of the axis to **Linear** or **Log10**. If you select **dB** scaling for the channel, the Y-axis is set to **Linear** automatically.

If a channel is configured for a strain gage or bridge-based sensor, you cannot choose dB scaling for the corresponding FFT channel.

---

- **dB Reference** – If you select **dB**, you can select one of the following dB reference values to use when computing dB: **Sensor full-scale** (the full-scale range of the sensor that you defined is used), **Acceleration (1e-3)**, **Velocity (1e-6)**, **Displacement (1e-9)**, or a **User-Defined** value. If you select **User-Defined**, change the default reference value to the value that you desire; this value must be greater than 0.
- **RMS, Peak, or Pk-Pk** – Allows you to scale the FFT data using **RMS** (the square root of the average of the square of the value of the function taken throughout one period, as shown in Figure 35), **Peak** (zero to Peak, as shown in Figure 36), or **PeakPeak** (the absolute value of the data from the negative peak to the positive peak, as shown in Figure 37).

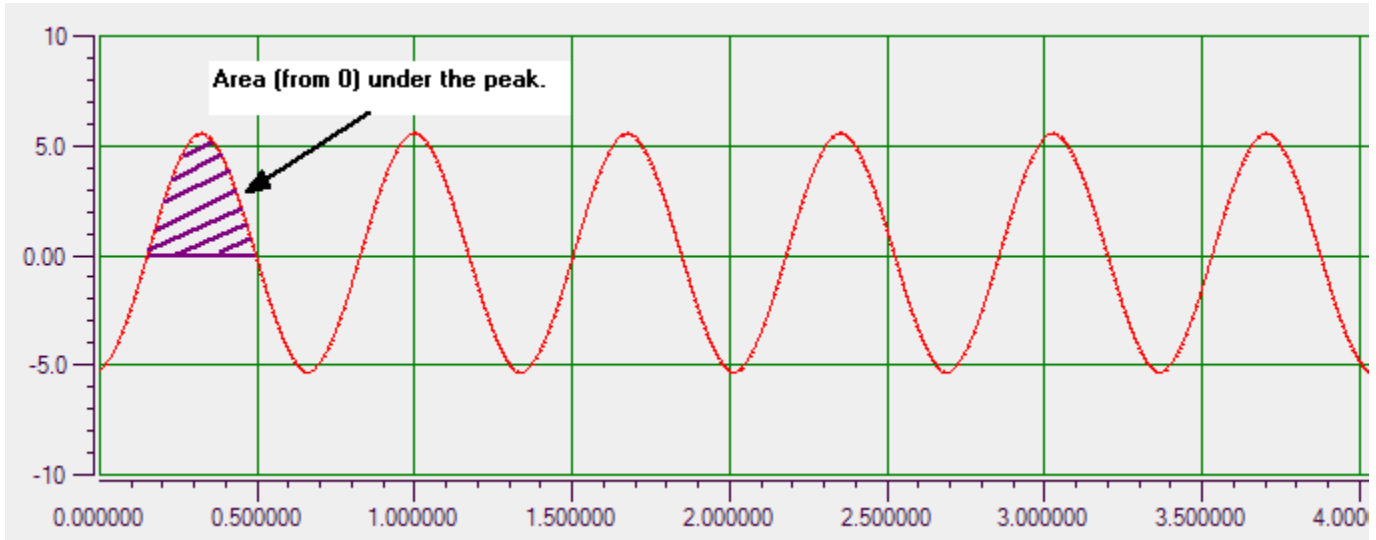

Figure 35: RMS (Square Root of the Average of the Squares)

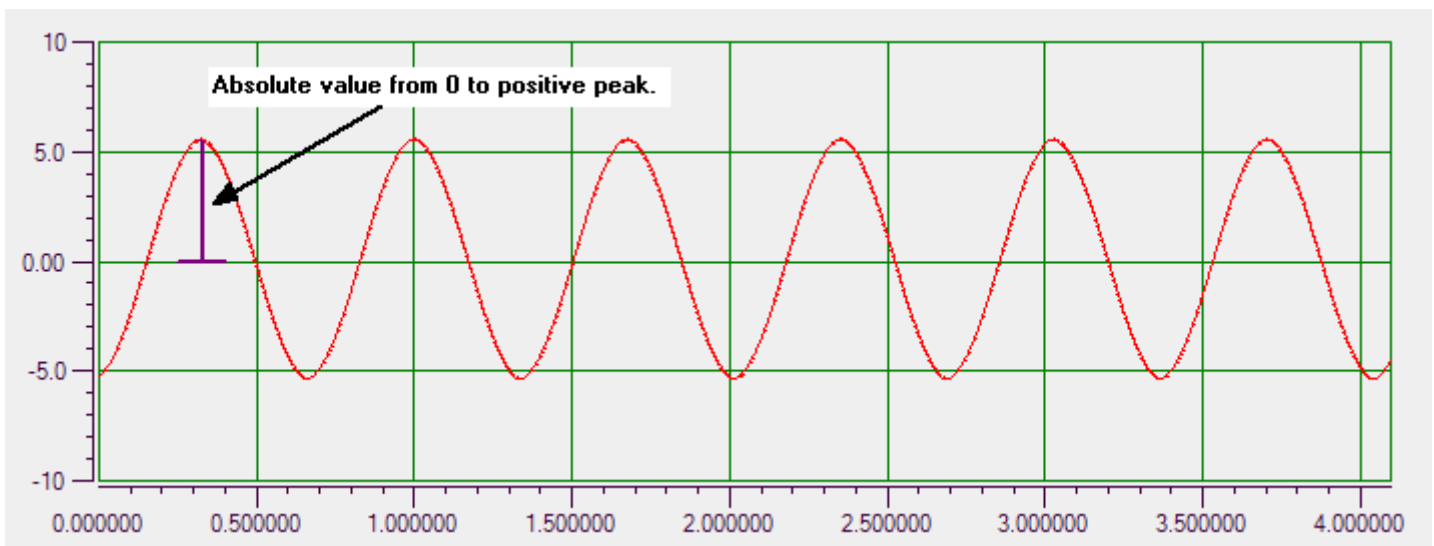

Figure 36: Peak (Zero to Peak)

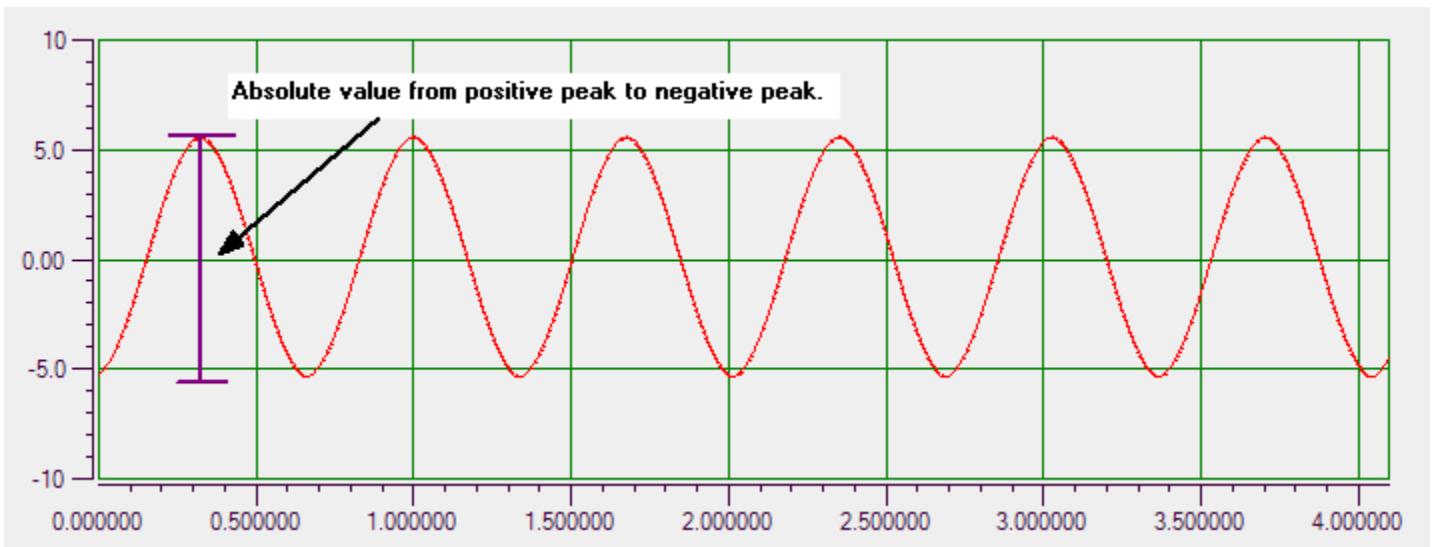
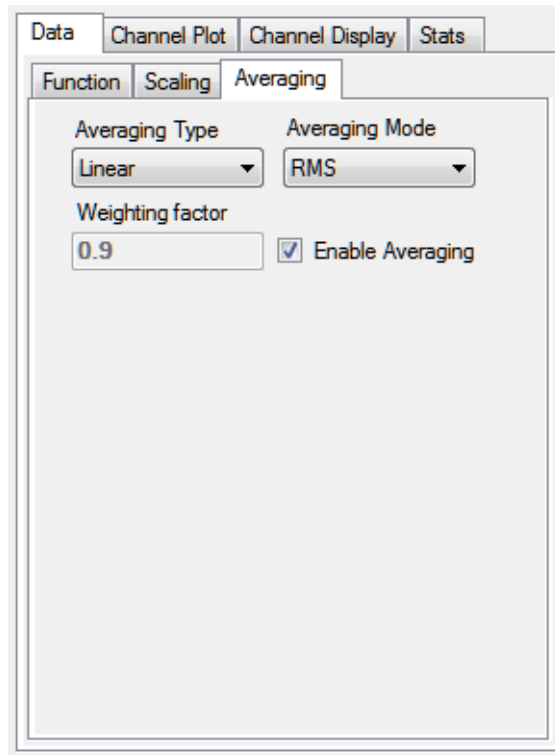

Figure 37: PeakPeak (Negative Peak to Positive Peak)

## Averaging Tab

The **Averaging** tab allows you specify how you want to average the data for the FFT channel.



- **Enable Averaging** – Enable averaging by selecting this checkbox, or disable averaging by unchecking this checkbox.

When this box is checked, the FFT plot shows the accumulated average result of the data at the completion of each acquired record.

- **Averaging Type** – If you want to average FFTs rather than showing an FFT for each individual record, choose one of the following spectral averaging types:
  - **Linear** – Data from each FFT is averaged with the data from the other FFTs; all data contributes equally to the average.
  - **Exponential** – New FFT data is weighted differently than older FFT data. You specify the weighting factor to apply, which either increases or decreases the effect of the new FFT data on the average. This is a continuous averaging type.
- **Weighting Factor** – If you choose **Exponential** as the spectral averaging type, enter the weighting factor to apply. The weighting factor either increases or decreases the effect of new FFT data on the resultant average using on the following formula:  
Result = ((New FFT Data) \* Weighting Factor) + (Old Average \* (1- Weighting Factor))
- **Averaging Mode** – Choose one of the following averaging mode to use:
  - **RMS** – RMS (root mean squared) averaging averages the power of the signal in real numbers directly. For single channel measurements, this results in zero phase. RMS averaging reduces signal fluctuations but not the noise floor.
  - **Vector** – Vector (angle) averaging computes the average of complex numbers directly. The real part of the number is averaged separately from the imaginary part of the number, reducing the noise floor for random signals. A trigger is usually required for this averaging mode.
  - **PeakHold** – With PeakHold averaging, the averaged data is a collection of points that represent the peak amplitude for each point in the FFT. With each new FFT, the current data is compared with the new data on a point by point basis. The highest amplitude for each point in the FFT is retained.

## Configuring Parameters for a Two-Channel FRF Function

This section applies to the Advanced FFT Analysis option of QuickDAQ.

If you have added a two-channel FRF (Frequency Response Function) channel, as described on [page 206](#), and selected it under the **Channel Name** column, you can configure the parameters of the FRF channel using the **Data** tab options:

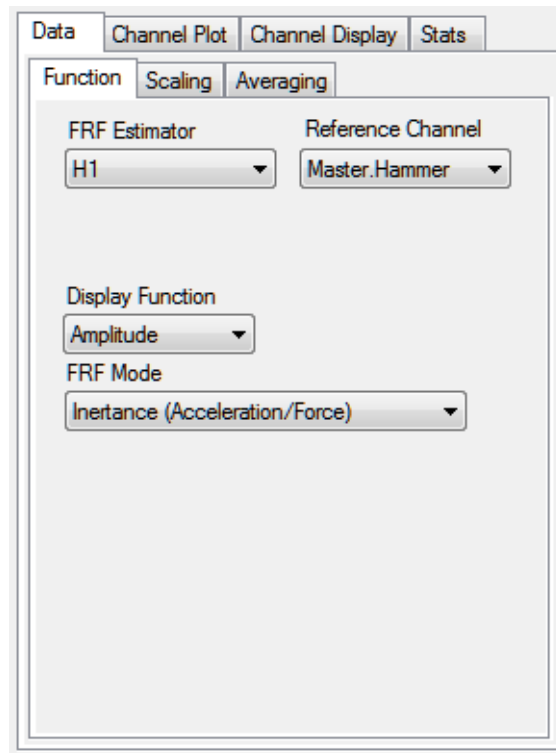

This section describes the options that appear under the **Data** tab if you select a two-channel FRF channel in the Plot and Data Config window.

---

**Note:** Once you have acquired data, you can change the parameters under the **Data** tab and see the effect of your changes immediately by checking the **Auto-reprocess on parameter change** checkbox. Or, if this checkbox is not checked, click the **Apply settings to current data button** to see the results.

---

## Function Tab

The **Function** tab provides the following selections: **FRF Estimator**, **Reference Channel**, **Display Function**, and **FRF Mode**.

### **FRF Estimator**

The **FRF Estimator** determines how the frequency response function is calculated. Choose one of the following settings for **FRF Estimator**:

- **H1** – Reduces noise on the response channel. It is calculated as follows:

$$H_1 = S_{xf}/S_{ff}$$

where,

$S_{xf}$  represents the average cross power spectrum between the response and the reference signals.

$S_{ff}$  represents the average auto power spectrum of the reference signal.

- **H2** – Reduces noise on the reference channel. It is calculated as follows:

$$H_2 = S_{xx}/S_{fx}$$

where,

$S_{xx}$  represents the average auto spectrum of the response signal.

$S_{fx}$  represents the average cross power spectrum between the response and the reference signals.

- **H3** – Reduces noise on both the reference and response channels. H3 is computed as follows:

$$H_3 = (H_1 + H_2)/2$$

### **Reference Channel**

From the list of reference channels that you configured using the **Input Channel Configuration** menu option, described on [page 86](#), select the reference channel that you want to compare with the selected response channel.

### **Display Function**

Under **Display Function**, choose one of these settings:

- **Amplitude** – Plots the magnitude of the frequency response gain.
- **Phase** – Plots the frequency response phase shift (angle).
- **Real** – Plots the real component of the complex resultant data on the y-axis against frequency on the x-axis.
- **Imaginary** – Plots the imaginary component of the complex resultant data on the y-axis against frequency on the x-axis.
- **Nyquist** – Plots the complex resultant data with the real components on the x-axis and imaginary components on the y-axis; the consecutive points are joined by line segments.



## **FRF Mode**

Choose one of the following FRF modes; based on the mode selected, the application sets the integration type for the response channel accordingly:

- **Inertance** – Calculated as Acceleration of Response Channel/Force of Reference Channel.
- **Mobility** – Calculated as Velocity of Response Channel/Force of Reference Channel.
- **Compliance** – Calculated as Displacement of Response Channel/Force of Reference Channel.
- **Apparent Mass** – Calculated as Force of the Reference Channel/Acceleration of Response Channel.
- **Impedance** – Calculated as Force of Reference Channel/Velocity of the Response Channel.
- **Dynamic Stiffness** – Calculated as Force of Reference Channel/Displacement of Response Channel
- **Custom** – When you select this option, you can enter a integration type for the response channel and an integration type for the reference channel, if desired. The following selections are available:
  - **None** – No integration; acceleration data is represented as acceleration.
  - **Single** – Data is integrated once; acceleration data is represented as velocity.
  - **Double** – Data is integrated twice; acceleration data is represented as displacement.

## Scaling Tab

The **Scaling** tab allows you specify how you want to scale the data of the FRF channel when it is plotted.

---

**Note:** The Scaling tab is not used if you select the Real, Imaginary, or Nyquist display function.

---

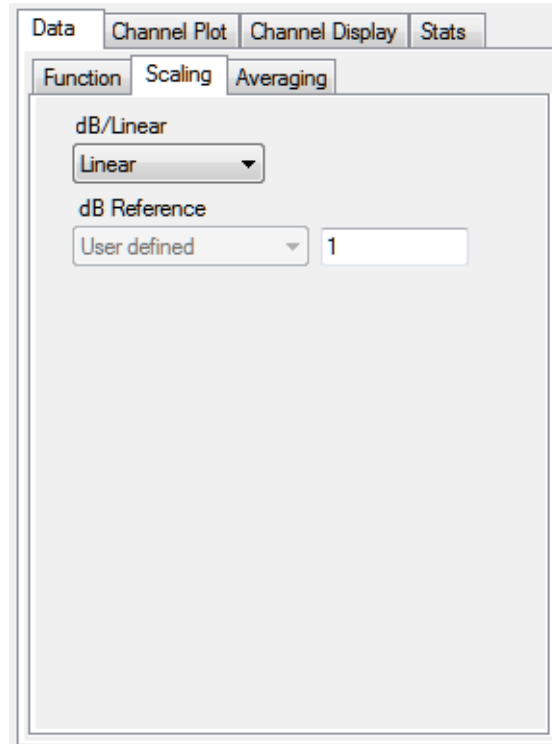

Select **Linear** for the engineering units of the sensor, such as *g* for an accelerometer, or **dB** for decibels.

---

**Note:** If you select **Linear** scaling for the channel, you can right-click on the axis of the plot, and select **Y Axis Setup** (for the y-axis) or **X Axis Setup** (for the x-axis) to change the scaling of the axis to **Linear** or **Log10**. If you select **dB** scaling for the channel, the Y-axis is set to **Linear** automatically.

---

If you select **dB**, **User-Defined** is selected by default for **dB Reference**. You can change the default reference value to a value that you desire; this value must be greater than 0.

## Averaging Tab

The **Averaging** tab allows you specify how you want to average the data for the FRF channel.

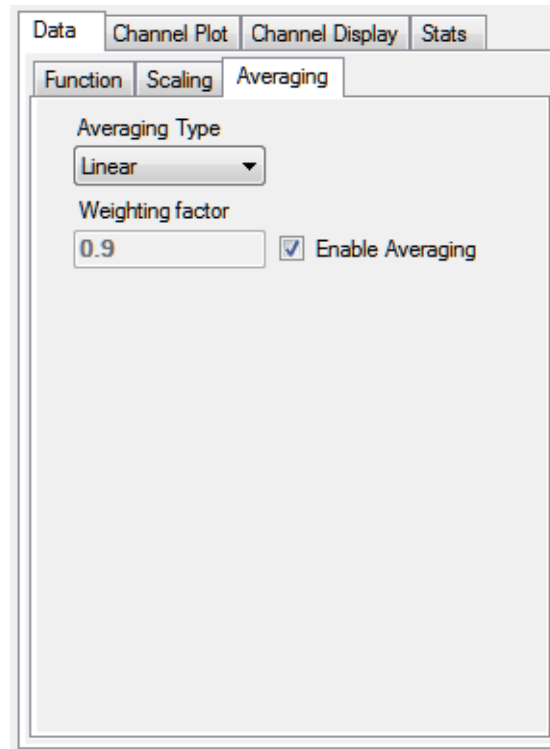

- **Enable Averaging** – Enable averaging by selecting this checkbox, or disable averaging by unchecking this checkbox.

When this box is checked, the FRF plot shows the accumulated average result of the data at the completion of each acquired record.

- **Averaging Type** – If you want to average FFTs rather than showing an FFT for each individual record, choose one of the following spectral averaging types:
  - **Linear** – Data from each FFT is averaged with the data from the other FFTs; all data contributes equally to the average.
  - **Exponential** – New FFT data is weighted differently than older FFT data. You specify the weighting factor to apply, which either increases or decreases the effect of the new FFT data on the average. This is a continuous averaging type.
- **Weighting Factor** – If you choose **Exponential** as the spectral averaging type, enter the weighting factor to apply. The weighting factor either increases or decreases the effect of new FFT data on the resultant average using on the following formula:

$$\text{Result} = ((\text{New FFT Data}) * \text{Weighting Factor}) + (\text{Old Average} * (1 - \text{Weighting Factor}))$$

## Configuring Parameters for a Two-Channel Cross Spectrum Function

This section applies to the Advanced FFT Analysis option of QuickDAQ.

Once you have added a two-channel Cross Spectrum channel, as described on [page 206](#), and selected it under the **Channel Name** column, you can configure the parameters of the Cross Spectrum channel using the **Data** tab options:

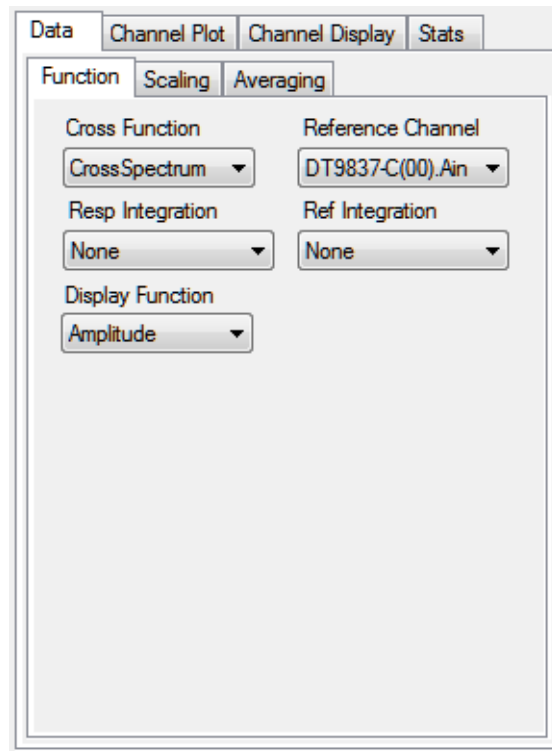

This section describes the options that appear under the **Data** tab if you select a two-channel Cross Spectrum channel in the Plot and Data Config window.

---

**Note:** Once you have acquired data, you can change the parameters under the **Data** tab and see the effect of your changes immediately by checking the **Auto-reprocess on parameter change** checkbox. Or, if this checkbox is not checked, click the **Apply settings to current data** button to see the results.

---

### Function Tab

The **Function** tab provides the following selections: **Cross Function**, **Reference Channel**, and **Resp Integration**, **Ref Integration**, and **Display Function**.

## **Cross Function**

Under **Cross Function**, choose one of the following settings:

- **Cross Spectrum** – A building block used in FRF and other more advanced functions. The cross-spectrum is defined as the product of the complex Fourier spectrum of the response channel multiplied by the complex conjugate of the Fourier spectrum of the reference channel.
- **Cross PSD** – (Cross Power Spectral Density) The distribution of power per unit frequency.

## **Reference Channel**

From the list of reference channels that you configured using the **Input Channel Configuration** menu option, described on [page 86](#), select the reference channel that you want to compare with the selected response channel.

## **Resp Integration**

For the selected response channel, choose one of the following integration types:

- **None** – No integration; acceleration data is represented as acceleration.
- **Single** – Data is integrated once; acceleration data is represented as velocity.
- **Double** – Data is integrated twice; acceleration data is represented as displacement.

## **Ref Integration**

For the selected reference channel, choose one of the following integration types:

- **None** – No integration; acceleration data is represented as acceleration.
- **Single** – Data is integrated once; acceleration data is represented as velocity.
- **Double** – Data is integrated twice; acceleration data is represented as displacement.

## **Display Function**

Under **Display Function**, choose one of these settings:

- **Amplitude** – Plots the magnitude of the frequency response gain.
- **Phase** – Plots the frequency response phase shift (angle).
- **Real** – Plots the real component of the complex resultant data on the y-axis against frequency on the x-axis.
- **Imaginary** – Plots the imaginary component of the complex resultant data on the y-axis against frequency on the x-axis.
- **Nyquist** – Plots the complex resultant data with the real components on the x-axis and imaginary components on the y-axis; the consecutive points are joined by line segments.

## Scaling Tab

The **Scaling** tab allows you specify how you want to scale the data when it is plotted.

---

**Note:** The Scaling tab is not used if you specify the Real, Imaginary, or Nyquist display function.

---

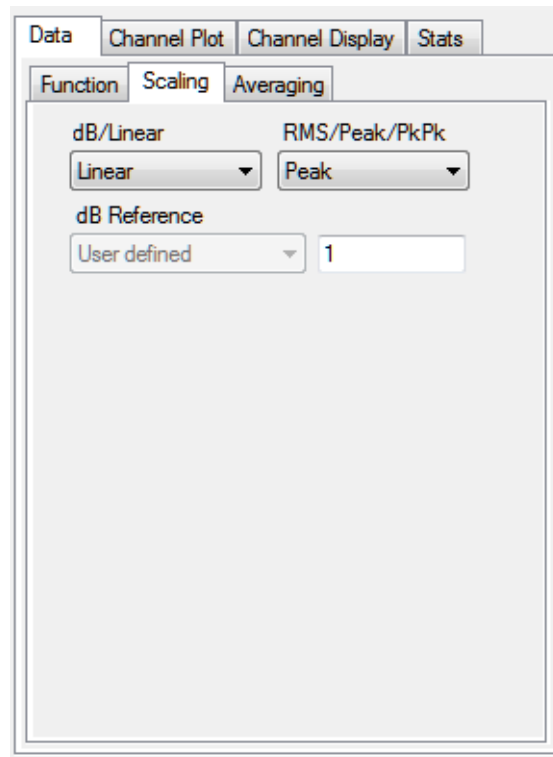

- **dB or Linear** – Select **dB** for decibels or **Linear** for the engineering units of the sensor, such as *g* for an accelerometer.

---

**Note:** If you select **Linear** scaling for the FFT channel, you can right-click on the axis of the plot, and select **Y Axis Setup** (for the y-axis) or **X Axis Setup** (for the x-axis) to change the scaling of axis to **Linear** or **Log10**. If you select **dB** scaling for the channel, the Y-axis is set to **Linear** automatically.

---

- **dB Reference** – If you select **dB**, **User-Defined** is selected by default. You can change the default reference value to a value that you desire; this value must be greater than 0.
- **RMS, Peak, or Pk-Pk** – Allows you to scale the FFT data using **RMS** (the square root of the average of the square of the value of the function taken throughout one period, as shown in [Figure 35 on page 212](#)), **Peak** (zero to Peak, as shown in [Figure 36 on page 212](#)), or **PeakPeak** (the absolute value of the data from the negative peak to the positive peak, as shown in [Figure 37 on page 213](#)).

## Averaging Tab

The **Averaging** tab allows you specify how you want to average the data.

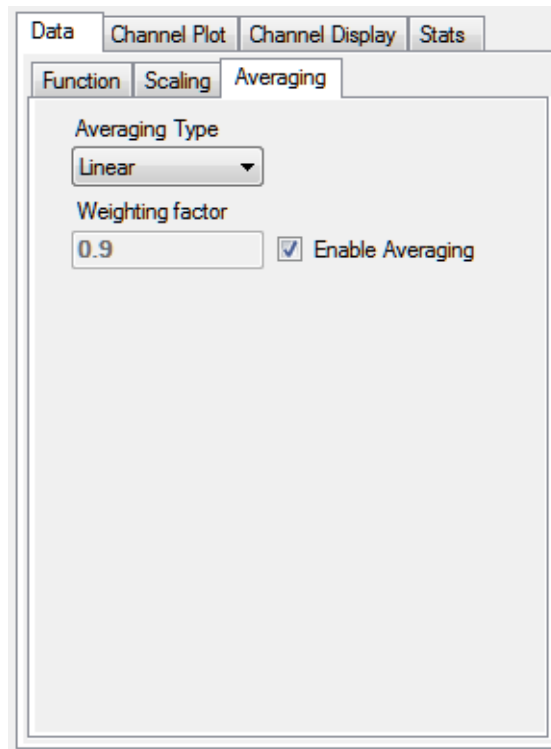

- **Enable Averaging** – Enable averaging by selecting this checkbox, or disable averaging by unchecking this checkbox.

When this box is checked, the Cross Spectrum plot shows the accumulated average result of the data at the completion of each acquired record.

- **Averaging Type** – If you want to average FFTs rather than showing an FFT for each individual record, choose one of the following spectral averaging types:
  - **Linear** – Data from each FFT is averaged with the data from the other FFTs; all data contributes equally to the average.
  - **Exponential** – New FFT data is weighted differently than older FFT data. You specify the weighting factor to apply, which either increases or decreases the effect of the new FFT data on the average. This is a continuous averaging mode.
- **Weighting Factor** – If you choose **Exponential** as the spectral averaging type, enter the weighting factor to apply. The weighting factor either increases or decreases the effect of new FFT data on the resultant average using on the following formula:  

$$\text{Result} = (\text{New FFT Data}) * \text{Weighting Factor} + (\text{Old Average} * (1 - \text{Weighting Factor}))$$

## Configuring Parameters for a Two-Channel Coherence Function

This section applies to the Advanced FFT Analysis option of QuickDAQ.

Once you have added a two-channel Coherence channel, as described on [page 206](#), and selected it under the **Channel Name** column, you can configure the parameters of the Coherence channel using the **Data** tab options:

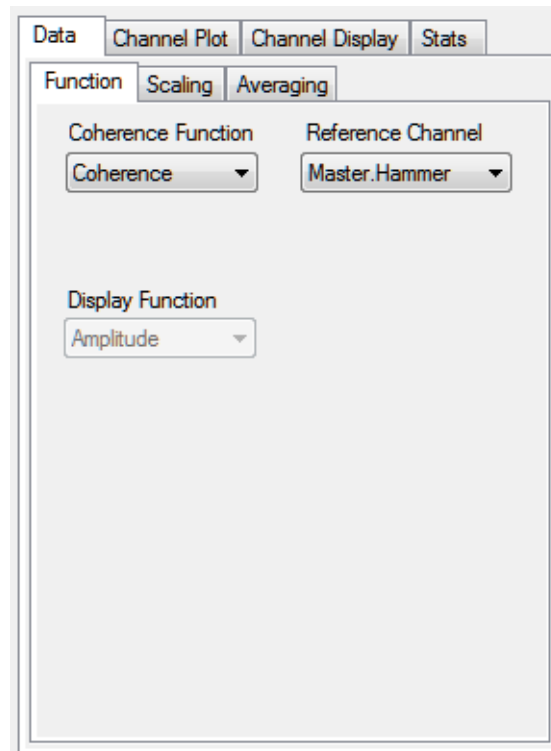

This section describes the options that appear under the **Data** tab if you select a two-channel Coherence channel in the Plot and Data Config window.

---

**Note:** Once you have acquired data, you can change the parameters under the **Data** tab and see the effect of your changes immediately by checking the **Auto-reprocess on parameter change** checkbox. Or, if this checkbox is not checked, click the **Apply settings to current data** button to see the results.

---

### Function Tab

The **Function** tab provides the following selections: **Coherence Function** and **Reference Channel**. These options are described in the following subsections.



## Coherence Function

Under **Coherence Function**, choose one of the following settings:

- **Coherence** – Evaluates the linearity between the reference signal and the response signal at each frequency, and generates a value between 0.0 and 1.0, where 0 is consistently not linear and 1.0 is consistently linear.
- **COP** – (Coherent Output Power) The COP function is the power of the response channel multiplied, at each frequency, by the coherence between the reference and the response channels.

## Reference Channel

From the list of reference channels that you configured using the **Input Channel Configuration** menu option, described on [page 86](#), select the reference channel that you want to compare with the selected response channel.

## Scaling Tab

For Coherence channels, **Linear** scaling is automatically selected for the **Scaling** tab; therefore, all choices for this tab are disabled.

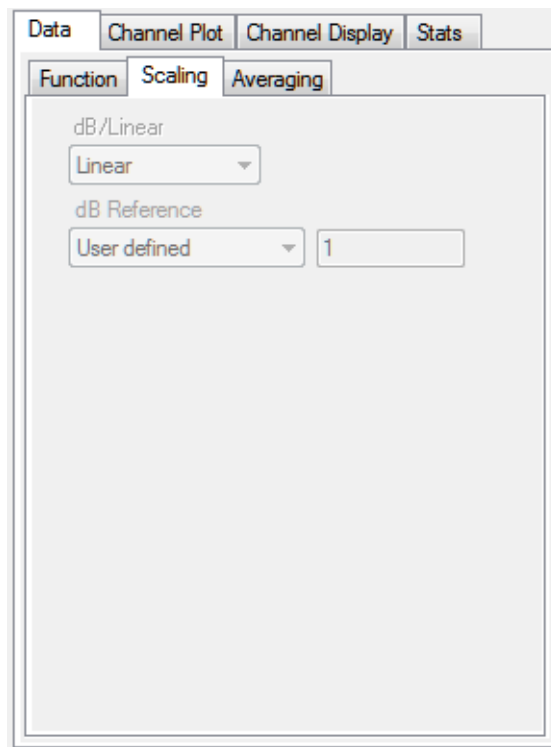



---

**Note:** You can right-click on the axis of the plot, and select **Y Axis Setup** (for the y-axis) or **X Axis Setup** (for the x-axis) to change the scaling of axis to **Linear** or **Log10**.

---

## Averaging Tab

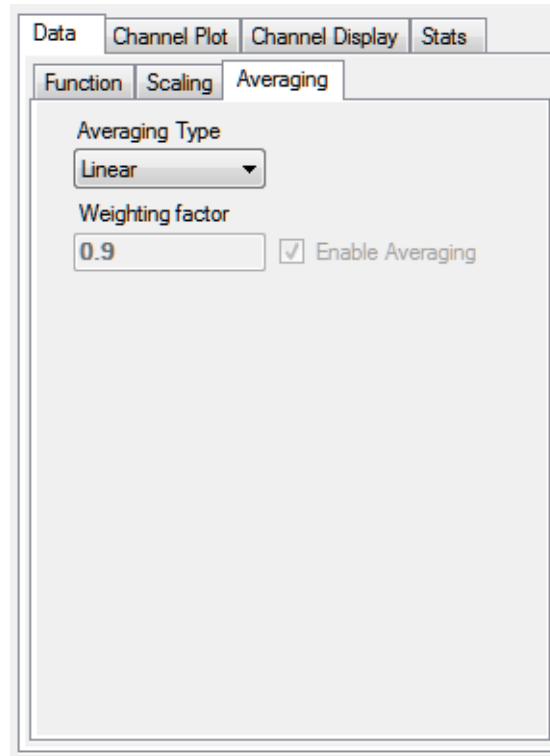
The **Averaging** tab allows you specify how you want to average the data for the Coherence channel.



- **Enable Averaging** – Averaging is always enabled for Coherence channels; therefore, this checkbox is disabled.

The Coherence plot shows the accumulated average result of the data at the completion of each acquired record.

- **Averaging Type** – If you want to average FFTs rather than showing an FFT for each individual record, choose one of the following spectral averaging modes:
  - **Linear** – Data from each FFT is averaged with the data from the other FFTs; all data contributes equally to the average.
  - **Exponential** – New FFT data is weighted differently than older FFT data. You specify the weighting factor to apply, which either increases or decreases the effect of the new FFT data on the average. This is a continuous averaging mode.
- **Weighting Factor** – If you choose **Exponential** as the spectral averaging type, enter the weighting factor to apply. The weighting factor either increases or decreases the effect of new FFT data on the resultant average using on the following formula:
 
$$\text{Result} = ((\text{New FFT Data}) * \text{Weighting Factor}) + (\text{Old Average} * (1 - \text{Weighting Factor}))$$

## Configuring Statistics for FFT Plots Using the Stats Tab

If you are using the FFT Analyzer interface, the **Stats** tab allows you to set up statistics for FFT and time-domain channels. This section describes how to set up statistics for FFT plots. Refer to [page 237](#) for more information on configuring statistics for the Statistics window.

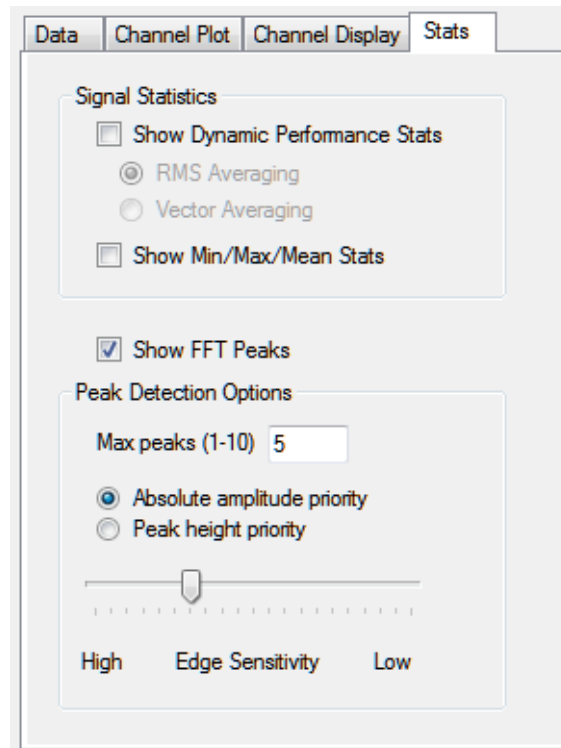

If you select **Show FFT Peaks**, a graphic similar to the following appears next to each FFT plot:

#	Freq	Val
1	78.1	-39.451
2	136.7	-39.877
3	449.2	-43.353

The peaks are ordered by height, and the frequency and values for the detected peaks are displayed.

You can configuring the following attributes for FFT peak detection:

- **Max peaks** – Select the number of peaks (1 to 10) that you want the application to detect and display in the FFT plot.
- **Absolute amplitude priority** – Determine whether the application detects the peak by Absolute amplitude or by Peak height.
- **Edge sensitivity** – Determine the sensitivity (high to low) with which the application detects the peak by adjusting the Edge sensitivity slider bar.

## Scrolling through FFTs for an Analog Input Channel

If you are using the FFT Analyzer interface and averaging is disabled for an FFT channel, you can use the **Record Number** box in the Acquisition Status window to scroll through the records that were acquired for the corresponding analog input channel once data is acquired.

For example, if 10 records were acquired for the analog input channels (0 to 9), and you are interested in looking at record number 3, set the Record Number to 3 and the plot for that FFT is displayed in the Channel Plot window.

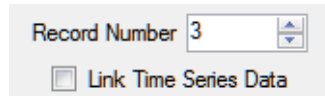

If you want to see the actual analog input data that corresponds to a particular Record Number, click the **Link Time Series Data** checkbox. The data plot for the corresponding analog input channels is then displayed for the selected record number.

## Configuring the Appearance of the Channel Display Window

This section describes the how to configure the appearance of the Channel Display window when using the FFT Analyzer interface, and includes the following topics:

- Displaying channels in the Channel Display window, described on this page
- Controlling how data is displayed in the Channel Display window, described on [page 232](#)
- Specifying the style of the Channel Display window, described on [page 234](#)

### Displaying Channels in the Channel Display Window

You can determine which channels are displayed in the Channel Display window by using the following controls in the Plot and Data Config window:

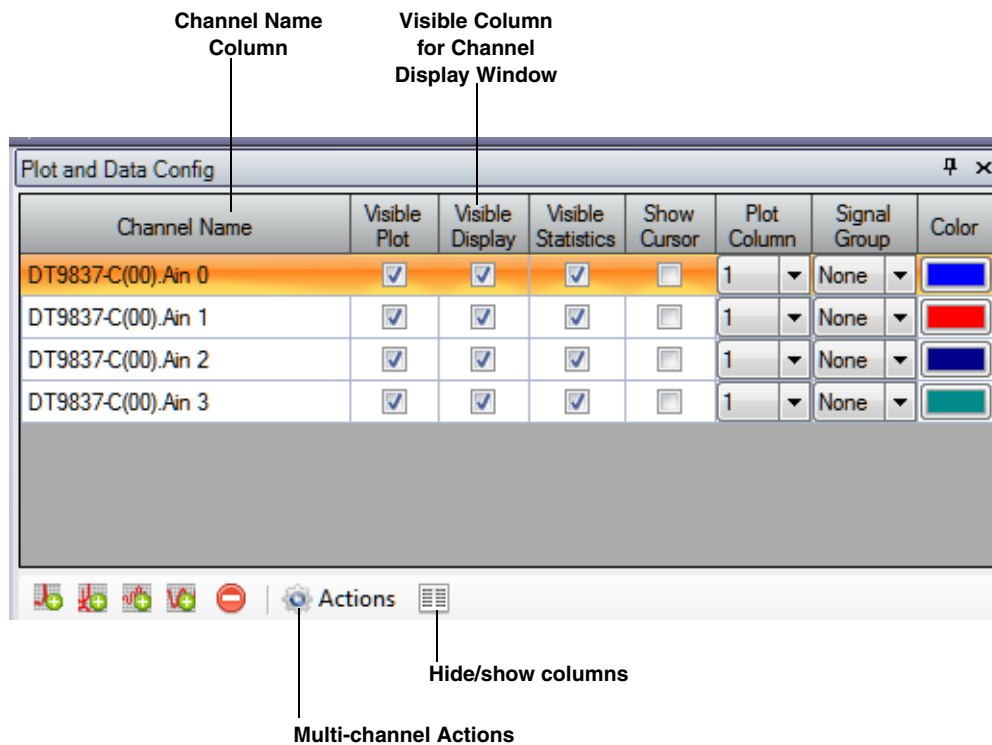

You can see the names of all enabled channels under the **Channel Name** column in the Plot and Data Config window. Only data from the list of enabled channels is acquired.

---

**Note:** If desired, you can change the name of a channel using the **Input Channel Configuration** menu option or toolbar button, described on [page 86](#).

---

For each enabled time-domain channel, you can control which channels are displayed in the Channel Display window using the **Visible Display** checkbox. If a box is checked under the **Visible Display** column, the data for the associated channel is displayed in the Channel Display window. If a box under the **Visible Display** column is unchecked, the data for the associated channel is not displayed in the Channel Display window.

---

**Note:** FFT channels cannot be displayed in the Channel Display window.

Data for all enabled time-domain channels is recorded regardless of whether the channel is visible.

---

### ***Making All Selected Channels Visible or Hidden in the Channel Display Window at Once***

If you want to make all selected channels visible in the Channel Display window at once, select the **Multi-channel Actions** button (  **Actions** ) button, and choose **Selected channels visible in Channel Display**.

If you want to hide all selected channels in the Channel Display window at once, select the **Multi-channel Actions** (  **Actions** ) button, and choose **Selected channels hidden in Channel Display**.

### ***Showing or Hiding the Visible Display Column***

If you wish, you can change whether the **Visible Display** column is shown or hidden by selecting the **Hide/show columns** (  ) button, and selecting **Visible Display**. A checkmark means the column is shown; no checkmark means the column is hidden.

### ***Moving the Visible Display Column***

If you wish, you can move the position of the **Visible Display** column by clicking the left-mouse button to select it, dragging it to the right or left, and letting go of the left-mouse button.

## Controlling How Data is Displayed in the Channel Display Window

Using the **Channel Display - Control** tab in the Plot and Data Config window, you can control how data is displayed in the Channel Display window.

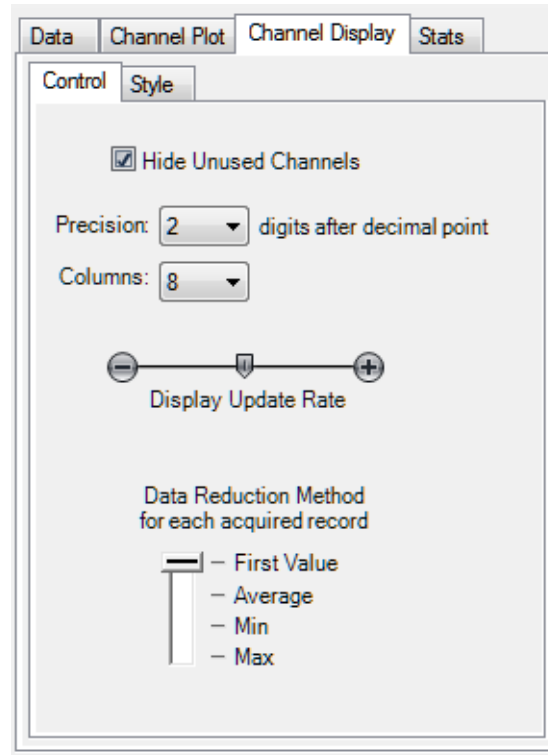

You can configure the following settings:

- **Hide Unused Channels** – The Channel Display window shows the channels on the device. By default, the **Hide Unused Channels** checkbox is checked; therefore, only the enabled channels are shown. If you want your display to show all the channels rather than just the enabled channels, uncheck the **Hide Unused Channels** box. The following example illustrates how the display looks when the **Hide Unused Channels** box is unchecked to show all the channels.

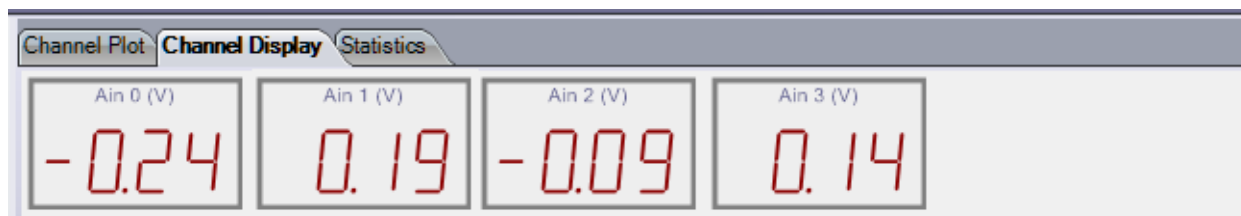



- **Precision** – You can select the number of significant digits after the decimal point to display; values range from 1 to 8 (2 is the default).
- **Columns** – You can specify how many columns to use when displaying the channels; values range from 1 to 16 (8 is the default). For example, by choosing 1, shown below, you can display each channel, one on top of the other (note that the lowest numbered channel is always at the top of the display and the highest numbered channel is at the bottom of the display):

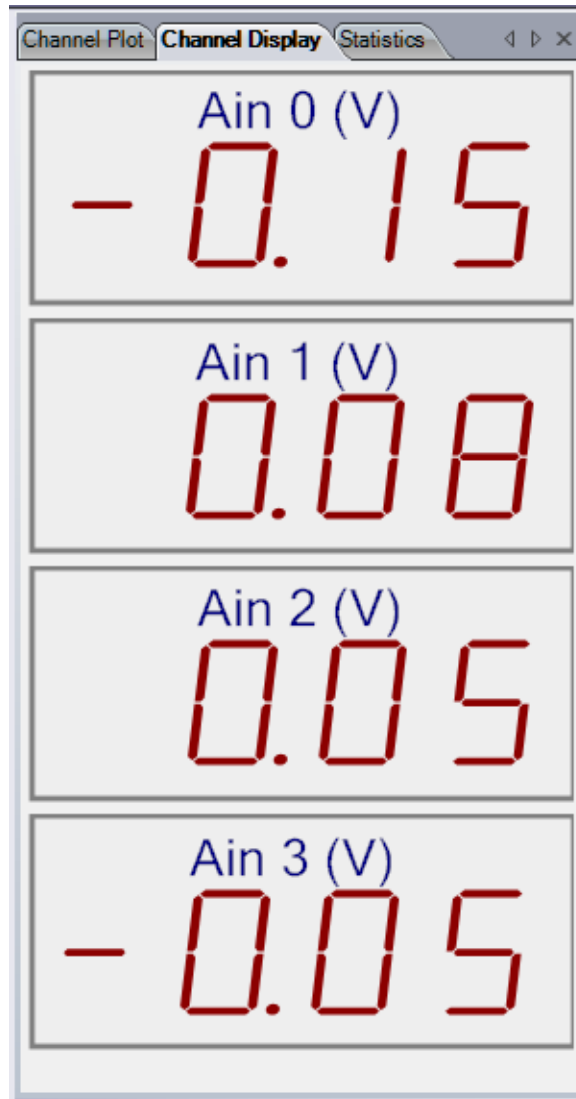

- **Display Update Rate** – You can choose how fast you want the display of the Channel Display window to be updated. Slide the bar to the left for faster update rates, or slide the bar to the right for slower update rates.

- **Data Reduction Method** – You can choose which value to display in the Channel Display window:
  - **First Value** – The first value in the most recent record is displayed for each channel.
  - **Average** – The average value in the most recent record is displayed for each channel.
  - **Min** – The minimum value in the most recent record is displayed for each channel.
  - **Max** – The maximum value in the most recent record is displayed for each channel.

## Specifying the Style of the Channel Display Window

Using the Channel Display - Style tab, you can specify the style of the Channel Display window.

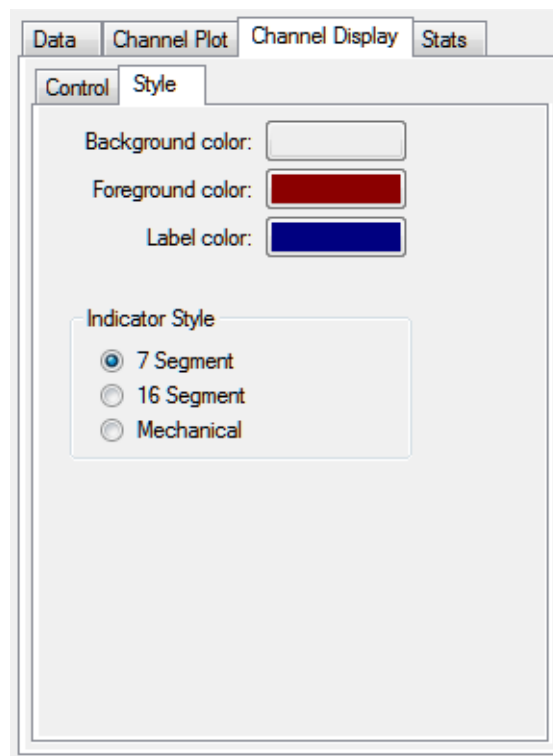

You can configure the following parameters:

- **Background color** – Allows you to choose a specific color for the background of the Channel Display window. You can select from a number of predefined colors or you can define your own color for the background.
- **Foreground color** – Allows you to choose a specific color for the foreground of the Channel Display window. You can select from a number of predefined colors or you can define your own color for the foreground.
- **Label color** – Allows you to choose a specific color for the label used on the Channel Display window. You can select from a number of predefined colors or you can define your own color for the label.

- **Indicator style** – Allows you to specify how the numbers and letters that represent the data appear. The following choices are available:
  - **7 Segment** – The numbers and letters that represent the data are composed of 7-segment lines.

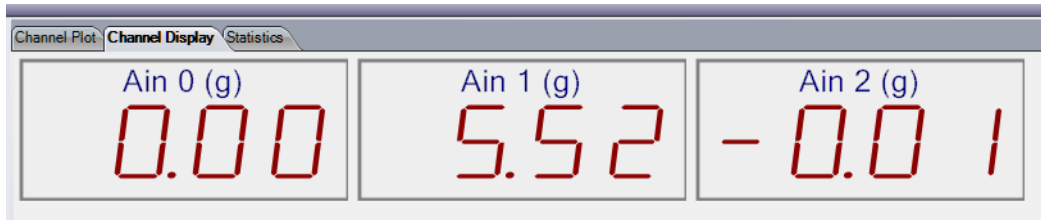

- **16 Segment** – The numbers and letters that represent the data are composed of 16-segment lines.

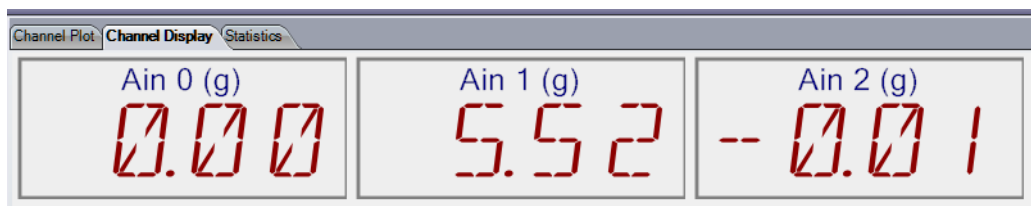

- **Mechanical** – The numbers and letters that represent the data appear to be formed by a contiguous line.



## Configuring the Appearance of the Statistics Window

This section describes the how to configure the appearance of the Statistics window when using the FFT Analyzer interface, and includes the following topics:

- Displaying channels in the Statistics window, described on this page
- Controlling how data is displayed in the Statistics window, described on [page 237](#)

### Displaying Channels in the Statistics Window

You can determine which channels are displayed in the Statistics window by using the following controls in the Plot and Data Config window:

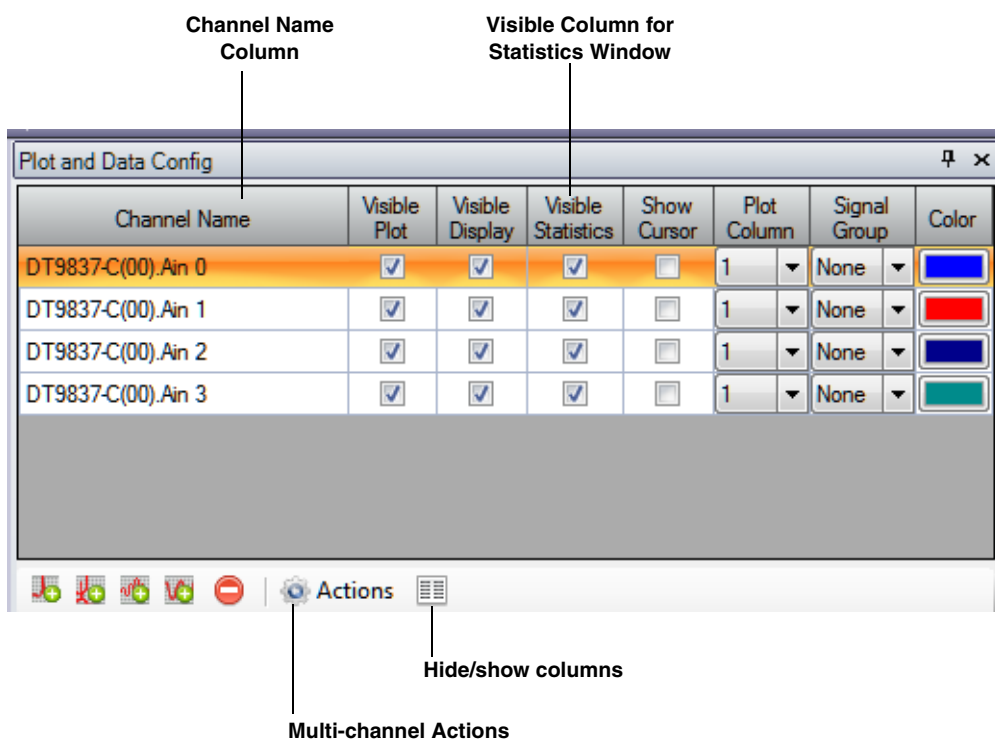

You can see the names of all enabled channels under the **Channel Name** column in the Plot and Data Config window. Only data from the list of enabled channels is acquired.

---

**Note:** If desired, you can change the name of a channel using the **Input Channel Configuration** menu option or toolbar button, described on [page 86](#).

---

For each enabled time-domain channel, you can control which channels are displayed in the Statistics window using the **Visible Statistics** checkbox. If a box is checked under the **Visible Statistics** column, the data for the associated channel is displayed in the Statistics window. If a box under the **Visible Statistics** column is unchecked, the data for the associated channel is not displayed in the Statistics window.

---

**Note:** Statistics are not created for FFT channels; therefore, statistics for FFT channels are not displayed in the Statistics window.

---

### ***Making All Selected Channels Visible or Hidden in the Statistics Window at Once***

If you want to make all selected channels visible in the Statistics window at once, select the **Multi-channel Actions** button (  **Actions** ) button, and choose **Selected channels visible in Statistics Display**.

If you want to hide all selected channels in the Channel Display window at once, select the **Multi-channel Actions** (  **Actions** ) button, and choose **Selected channels hidden in Statistics Display**.

### ***Showing or Hiding the Visible Statistics Column***

If you wish, you can change whether the **Visible Statistics** column is shown or hidden by selecting the **Hide/show columns** (  ) button, and selecting **Visible Statistics**. A checkmark means the column is shown; no checkmark means the column is hidden.

### ***Moving the Visible Statistics Column***

If you wish, you can move the position of the **Visible Statistics** column by clicking the left-mouse button to select it, dragging it to the right or left, and letting go of the left-mouse button.

## **Controlling How Data is Displayed in the Statistics Window**

Using the **Stats** tab in the Plot and Data Config window, you can control how data is displayed in the Statistics window.

---

**Note:** Refer to [page 227](#) for information on using the Stats tab to configure statistics for FFT plots. Statistics for FFT plots are displayed in the Channel Plot window for the FFT channel.

---

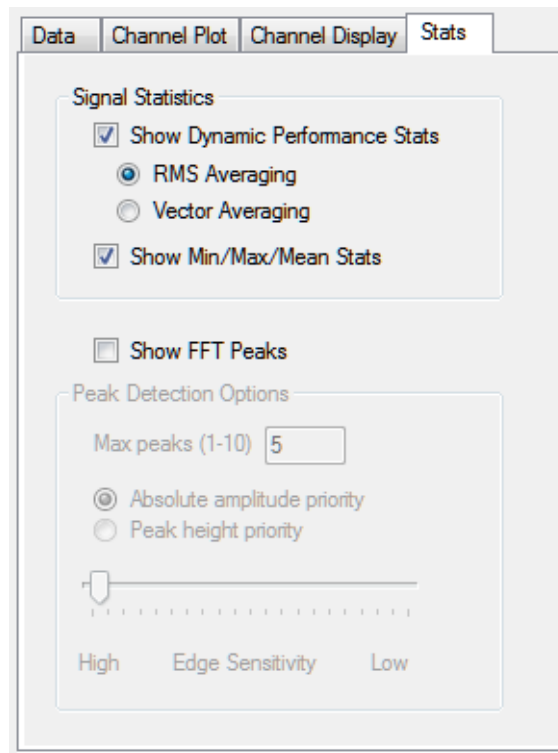

### Showing Dynamic Performance Statistics

By selecting **Show Dynamic Performance Stats**, you can quantify the analog characteristics of the data that is acquired through the A/D converter on the device.

When the **Show Dynamic Performance Stats** option is selected, an FFT is performed on the data for the selected time-domain channels (but you do not see the FFT plot.) The returned FFT data contains the DC amplitude, main signal amplitude, harmonic amplitude, and noise amplitude of the signal at specific frequencies. You can select one of the following averaging types to compute the FFT components:

- **RMS** – (Root Mean Squared) – Averages the power of the signal in real numbers directly. For single channel measurements, this results in zero phase. RMS averaging reduces signal fluctuations but not the noise floor.
- **Vector** – (Angle) – Averaging computes the average of complex numbers directly. The real part of the number is averaged separately from the imaginary part of the number, reducing the noise floor for random signals.

Note that to use this type of averaging, the trigger source (specified on the Trigger tab), must be either an external TTL trigger, threshold trigger, or software trigger (if you are also using the analog output channel as the input source). It cannot be a Free Run trigger.

Once the FFT is performed, additional mathematical operations are done on the data to compute the following statistics:

- IBF – Input Below Full-Scale
- THD – Total Harmonic Distortion

- SFDR – Spurious Free Dynamic Range
- SINAD – Signal-to-Noise And Distortion
- SNR – Signal-to-Noise Ratio
- ENOB – Effective Number of Bits

The following sections describe the dynamic performance statistics in detail.

---

**Note:** The FFT Analysis and Advanced FFT Analysis options of QuickDAQ always use a Blackman Harris window to compute dynamic performance statistics due to its steep side lobe roll-off characteristics. The user-selected FFT window is still applied to FFT plots and time-domain window plots, but is not used to compute dynamic signal statistics.

---

### IBF – Input Below Full-Scale

The IBF value, returned in dB, represents the level of the main signal component relative to the full-scale voltage, as shown in [Figure 38](#).

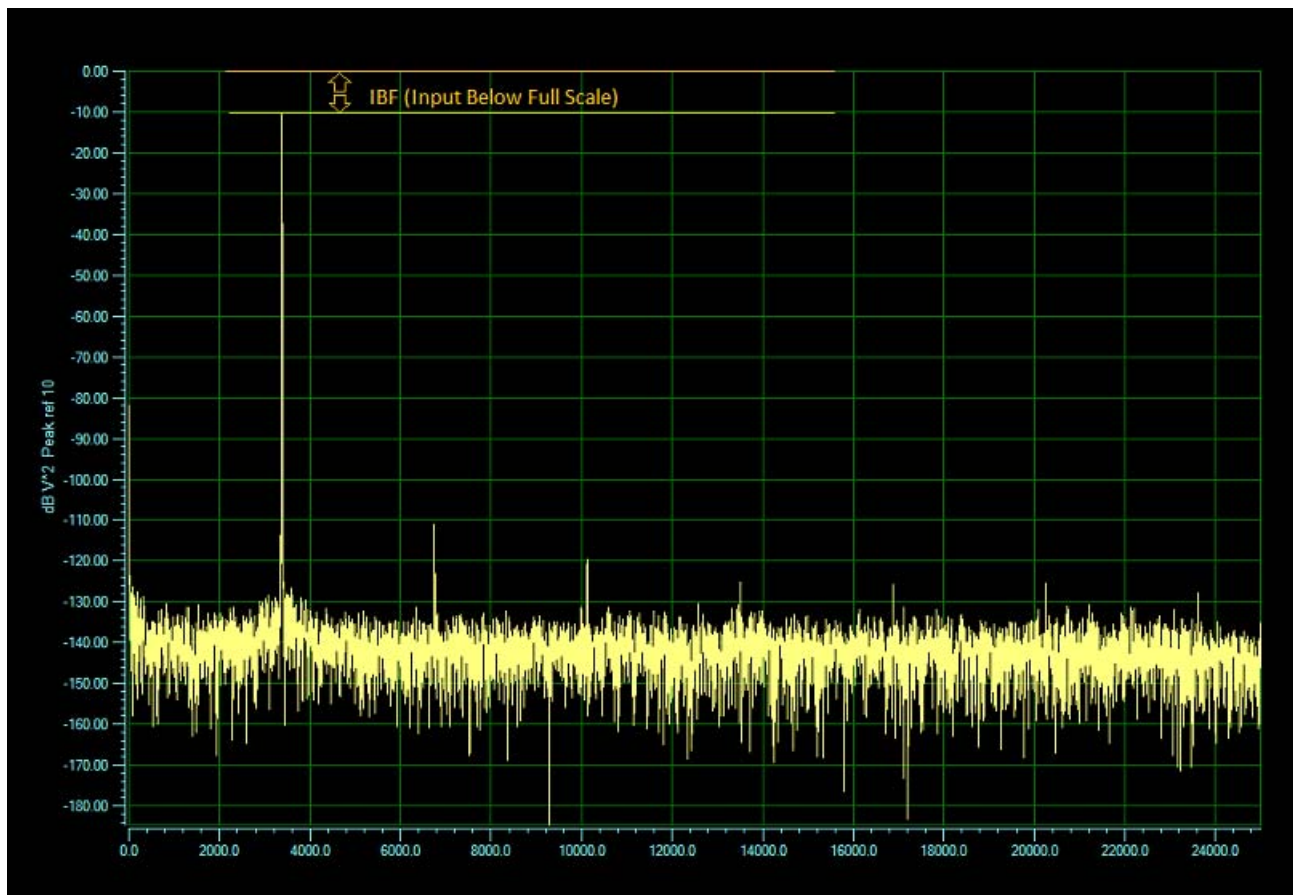

Figure 38: IBF (Input Below Full-Scale)

IBF is computed using the following equation:

$$IBF = 20 \cdot \log_{10} \left( \frac{V_s}{V_f} \right)$$

where  $V_s$  is the main signal component and  $V_f$  is the full-scale voltage.

For example, if a  $\pm 1$  V sine wave is applied to an analog input channel that is configured for a  $\pm 10$  V range, IBF is computed as follows:

$$IBF = 20 \cdot \log_{10} \left( \frac{1}{10} \right) = -20dB$$

### THD – Total Harmonic Distortion

The THD value, returned in dB and %, represents the level of the harmonic distortion of the first five harmonics relative to the main signal component, as shown in [Figure 39](#).

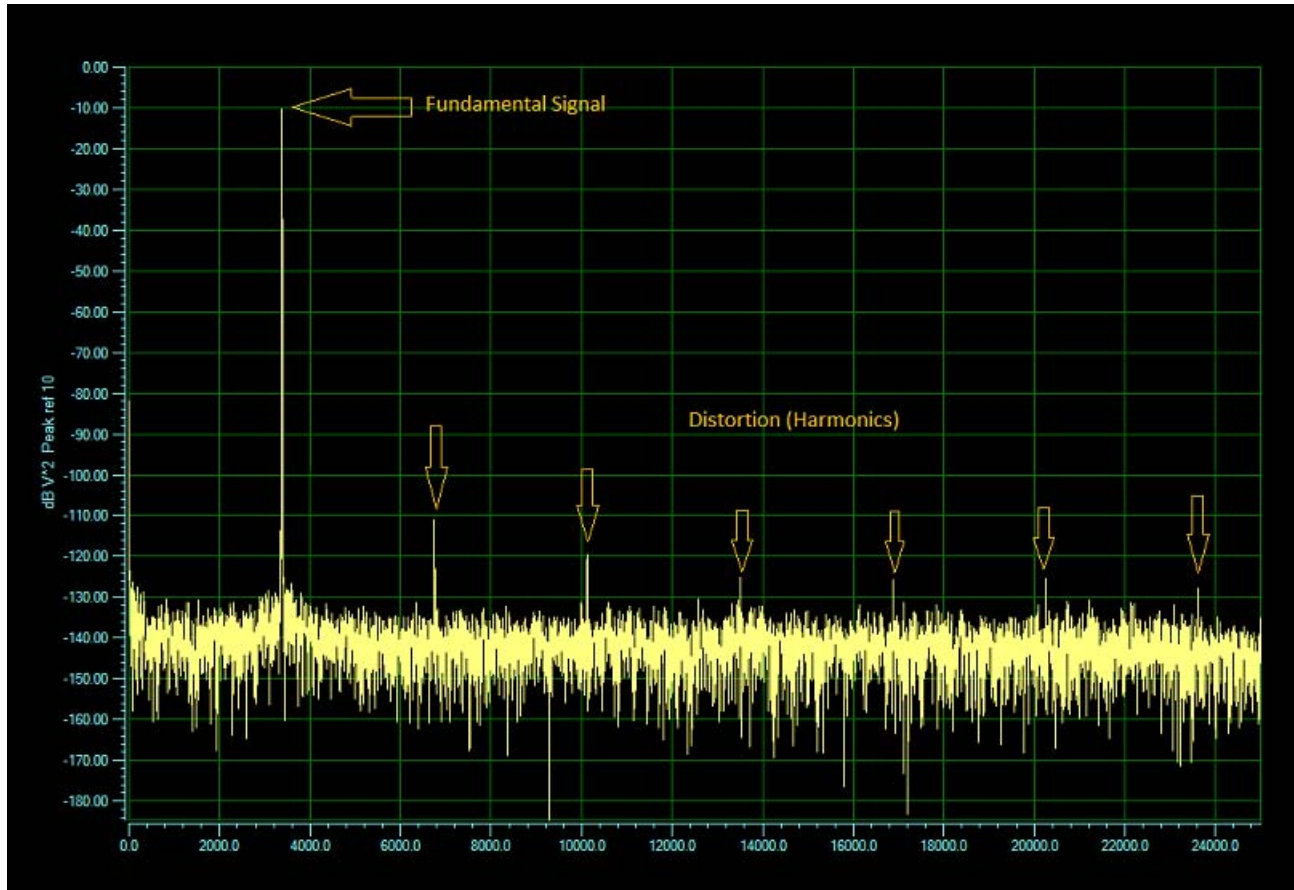

Figure 39: THD (Total Harmonic Distortion)



THD is computed using the following equation:

*dB:*

$$THD = 20 \cdot \log_{10} \left( \frac{\sqrt{h_1^2 + h_2^2 + h_3^2 + h_4^2 + h_5^2}}{V_s} \right)$$

*%:*

$$THD = \left( \frac{\sqrt{h_1^2 + h_2^2 + h_3^2 + h_4^2 + h_5^2}}{V_s} \right) \cdot 100$$

For example, if a 7.07 V<sub>RMS</sub> sine wave is applied to an analog input channel that is configured for a ±10 V range and the distortion (first five harmonics) is 14 μV<sub>RMS</sub>, THD is computed as follows:

$$THD = 20 \cdot \log_{10} \left( \frac{0.00001414}{7.07} \right) = -114dB$$

### SFDR – Spurious Free Dynamic Range

The SFDR value, returned in dB, represents the level of the full-scale range to the greatest noise or distortion component, as shown in Figure 40.

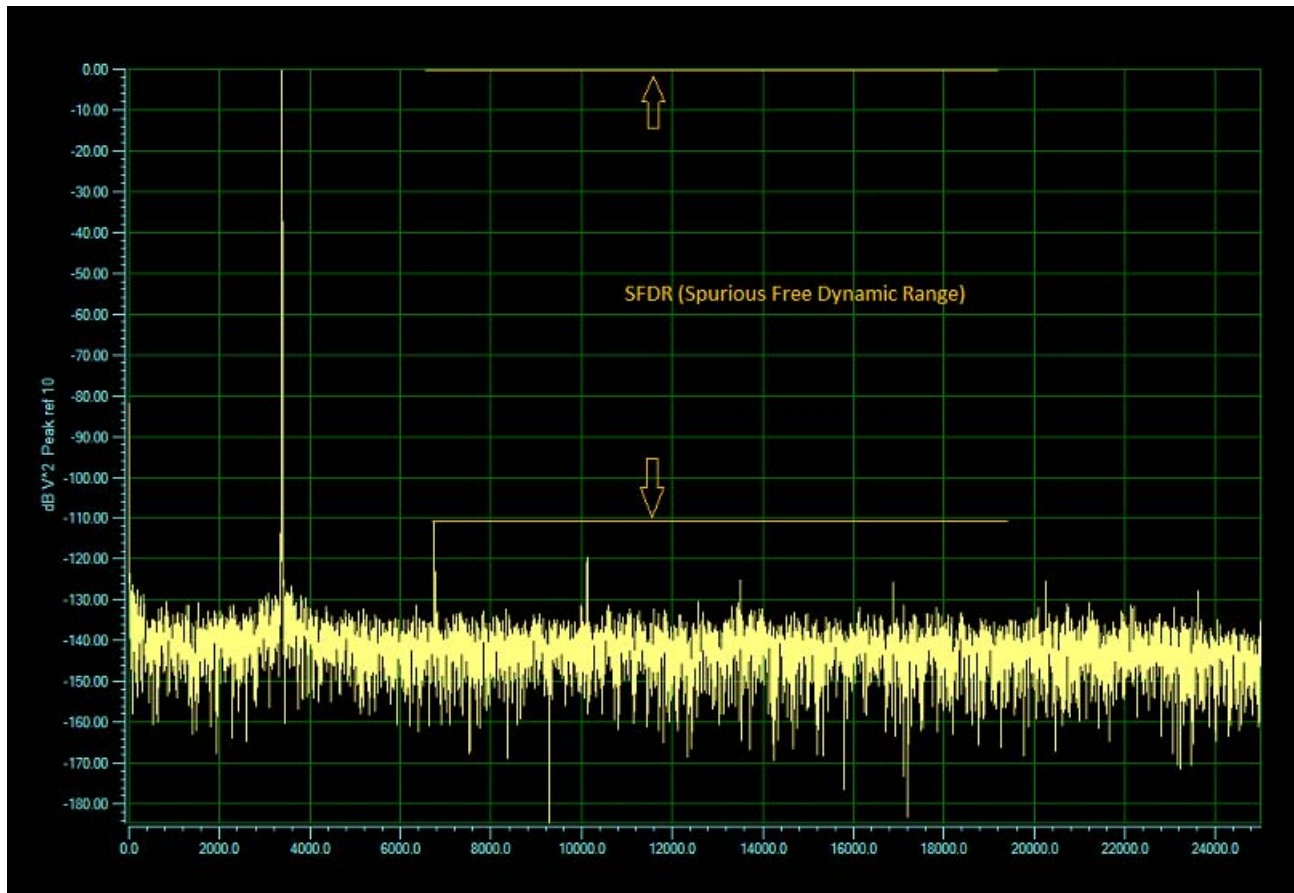

Figure 40: SFDR (Spurious Free Dynamic Range)

SFDR is computed using the following equation:

$$SFDR = 20 \cdot \log_{10} \left( \frac{V_f}{V_a} \right)$$

where  $V_f$  is the full-scale range and  $V_a$  is the greatest noise component.

For example, if the analog input channel is configured for a  $\pm 10$  V range, and the greatest noise or distortion component is  $7.07$   $V_{\text{RMS}}$ , SFDR is computed as follows:

$$SFDR = 20 \cdot \log_{10}\left(\frac{7.07}{0.00000707}\right) = 120\text{dB}$$

### SINAD – Signal-to-Noise and Distortion Ratio

The SINAD value, returned in dB, represents the level of the main signal component relative to the total noise,  $V_{\text{RMS}}$ , including harmonics, as shown in [Figure 41](#).

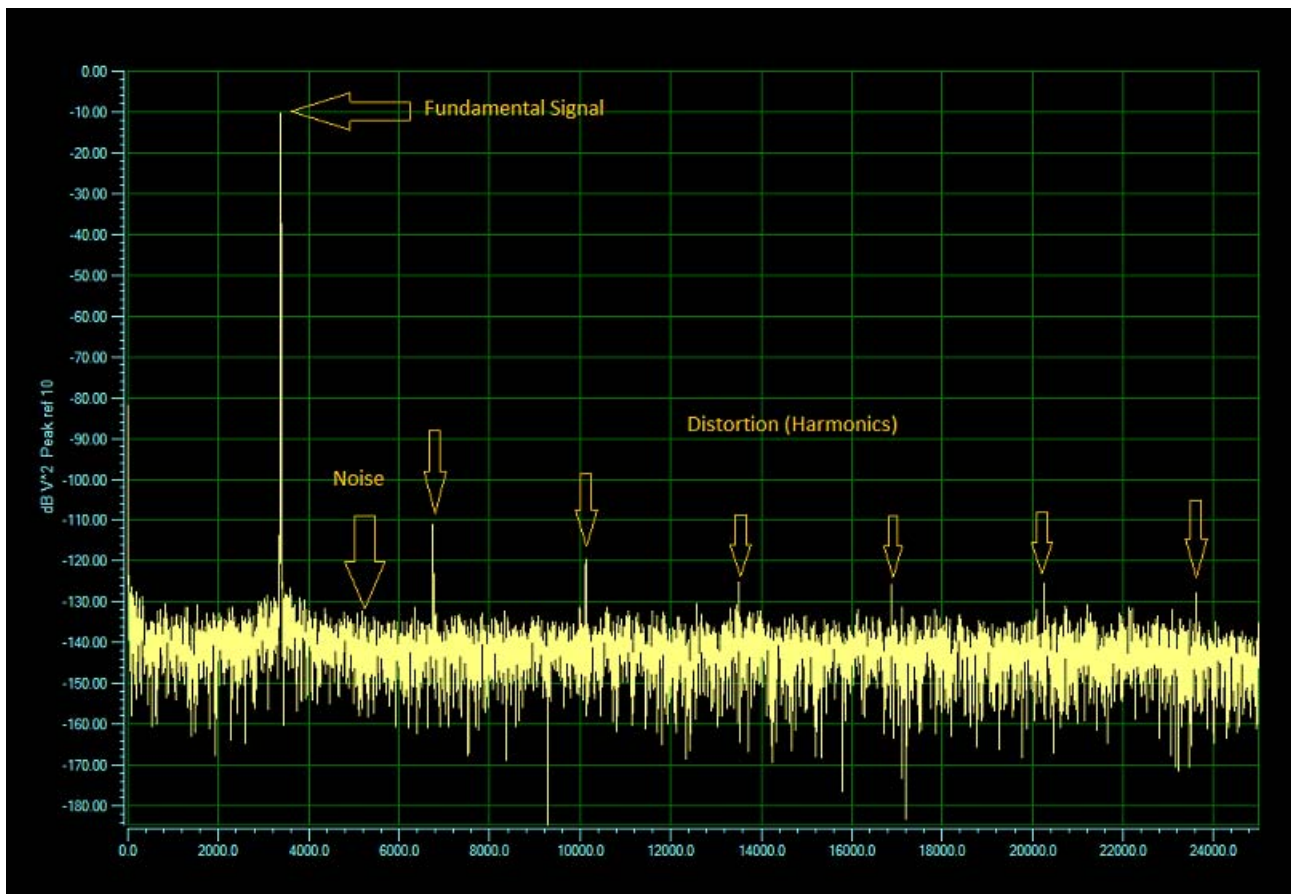

Figure 41: SINAD (Signal-to-Noise And Distortion) Statistic

SINAD is computed using the following equation:

$$SINAD = 20 \cdot \log_{10} \left( \frac{V_s}{V_{n+d}} \right)$$

where  $V_s$  is the main signal component and  $V_{n+d}$  is the total noise plus distortion.

For example, if a 7.07 V<sub>RMS</sub> sine wave is applied to an analog input channel that is configured for a ±10 V range and the total noise and harmonics (distortion) is 14.14 μV<sub>RMS</sub>, SINAD is computed as follows:

$$SINAD = 20 \cdot \log_{10} \left( \frac{7.07}{0.00001414} \right) = 114dB$$

## SNR – Signal-to-Noise Ratio

The SNR value, returned in dB, represents the level of the main signal component relative to the total noise,  $V_{RMS}$ , as shown in [Figure 42](#). Note that harmonics are not included in the noise.

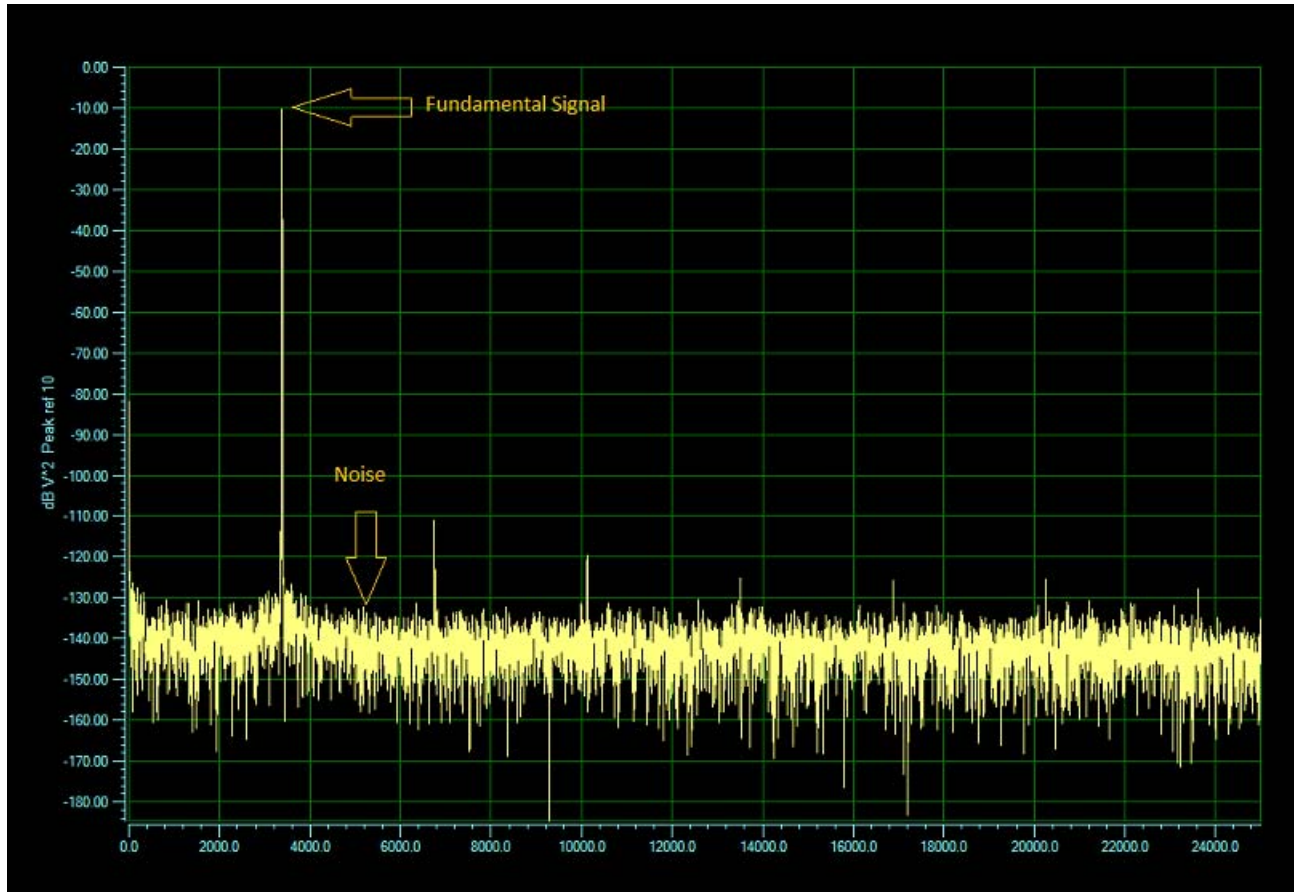

**Figure 42: SNR (Signal-to-Noise Ratio) Statistic**

SNR is computed using the following equation:

$$SNR = 20 \cdot \log_{10} \left( \frac{V_s}{V_n} \right)$$

where  $V_s$  is the main signal component and  $V_n$  is the total noise.

For example, if a  $7.07 V_{RMS}$  sine wave is applied to an analog input channel that is configured for a  $\pm 10 V$  range and the total noise is  $7.07 \mu V_{RMS}$ , SNR is computed as follows:

$$SNR = 20 \cdot \log_{10} \left( \frac{7.07}{0.00000707} \right) = 120dB$$

### **ENOB – Effective Number of Bits**

The ENOB value, returned in bits, represents the quality of a digitized signal. The input signal is typically sinusoidal and should be near full-scale to properly characterize the A/D converter and/or system.

ENOB is computed using the following equation:

$$ENOB = \frac{SINAD - 1.76 - IBF}{6.02}$$

For example, if a  $\pm 9 V$  sine wave is applied to an analog input channel that is configured for a  $\pm 10 V$  range and the average noise floor plus distortion (harmonics) is  $30 \mu V$  peak, the ENOB is computed as follows:

$$ENOB = \frac{109.54 - 1.76 - (-0.92)}{6.02} = 18.06bits$$

### **Showing Min/Max/Mean Statistics**

If you select **Show Min/Max/Mean Stats**, you can view the following statistics for the selected time-domain channels:

- Min – The minimum value in the engineering units for that channel.
- Max – The maximum value in the engineering units for that channel.
- Delta – The difference between the minimum and maximum value in the engineering units for that channel.
- Mean – The average value for the channel in the engineering units for that channel.
- Std Dev – The standard deviation for the channel.



## ***Examples Using the Data Logger Interface***

Example of Measuring Temperature and Voltage .....	248
Example of Monitoring an Analog Output Signal .....	259

## Example of Measuring Temperature and Voltage

In this example, the Data Logger interface of QuickDAQ is used to configure, measure, and display temperature and voltage data from a data acquisition device. For this example, the following sensors are connected to a MEASURpoint instrument:

- T thermocouple connected to analog input channel 0
- 4-wire, Euro PT1000 RTD connected to analog input channel 8
- $\pm 10$  V input signal connected to analog input channel 16

### Configure the Channels

Configure the channels as follows:

1. Configure each analog input channel by clicking the **Configuration** menu, and clicking **Input Channel Configuration**, or by clicking the **Input Channel Configuration** toolbar button (  ).
2. Enable analog input channels 0, 8, and 16 by clicking the checkbox under the **Enable** column.

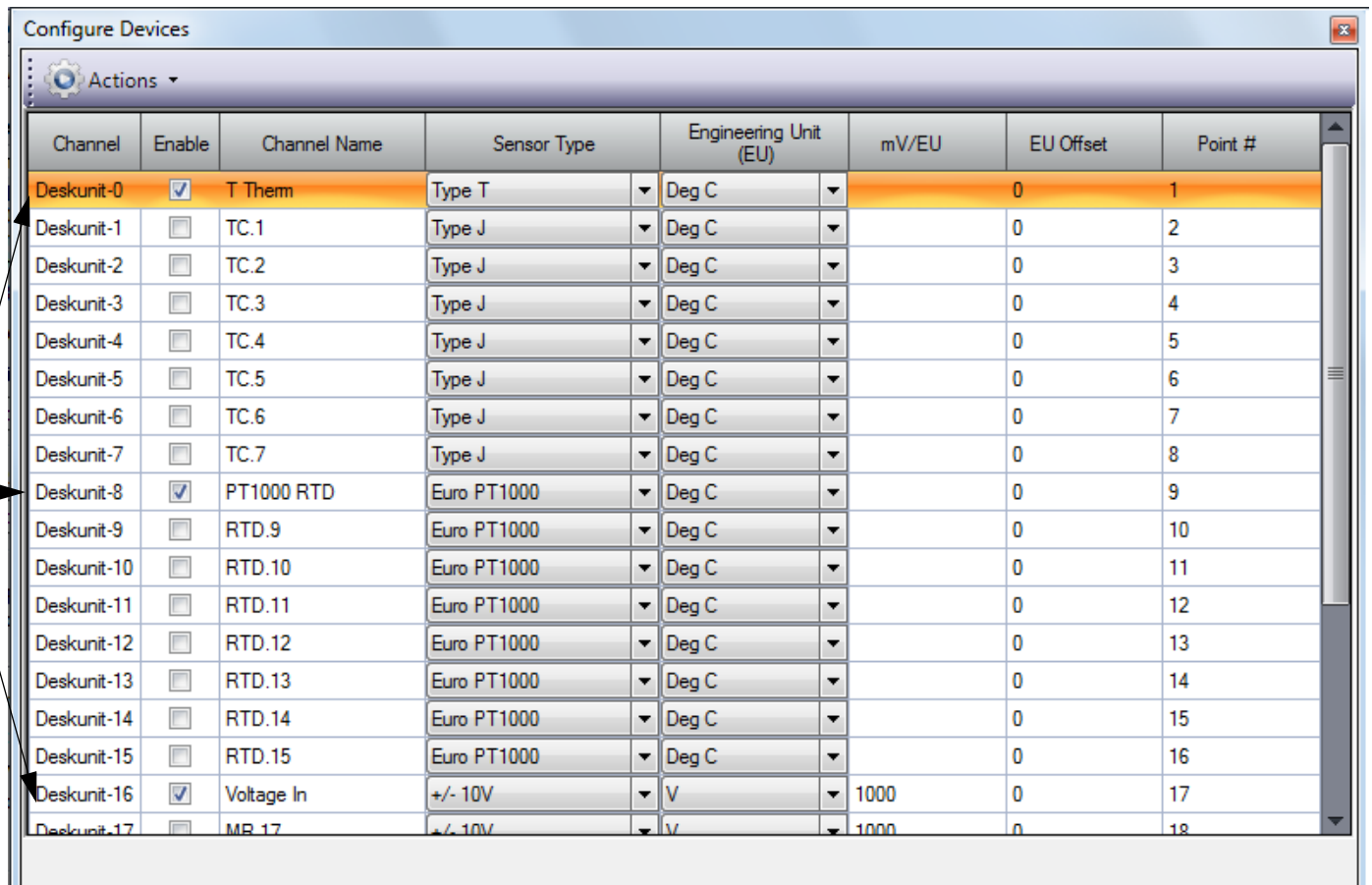

Channel	Enable	Channel Name	Sensor Type	Engineering Unit (EU)	mV/EU	EU Offset	Point #
Deskunit-0	<input checked="" type="checkbox"/>	T Them	Type T	Deg C		0	1
Deskunit-1	<input type="checkbox"/>	TC.1	Type J	Deg C		0	2
Deskunit-2	<input type="checkbox"/>	TC.2	Type J	Deg C		0	3
Deskunit-3	<input type="checkbox"/>	TC.3	Type J	Deg C		0	4
Deskunit-4	<input type="checkbox"/>	TC.4	Type J	Deg C		0	5
Deskunit-5	<input type="checkbox"/>	TC.5	Type J	Deg C		0	6
Deskunit-6	<input type="checkbox"/>	TC.6	Type J	Deg C		0	7
Deskunit-7	<input type="checkbox"/>	TC.7	Type J	Deg C		0	8
Deskunit-8	<input checked="" type="checkbox"/>	PT1000 RTD	Euro PT1000	Deg C		0	9
Deskunit-9	<input type="checkbox"/>	RTD.9	Euro PT1000	Deg C		0	10
Deskunit-10	<input type="checkbox"/>	RTD.10	Euro PT1000	Deg C		0	11
Deskunit-11	<input type="checkbox"/>	RTD.11	Euro PT1000	Deg C		0	12
Deskunit-12	<input type="checkbox"/>	RTD.12	Euro PT1000	Deg C		0	13
Deskunit-13	<input type="checkbox"/>	RTD.13	Euro PT1000	Deg C		0	14
Deskunit-14	<input type="checkbox"/>	RTD.14	Euro PT1000	Deg C		0	15
Deskunit-15	<input type="checkbox"/>	RTD.15	Euro PT1000	Deg C		0	16
Deskunit-16	<input checked="" type="checkbox"/>	Voltage In	+/- 10V	V	1000	0	17
Deskunit-17	<input type="checkbox"/>	MB.17	+/- 10V	V	1000	0	18



3. Under the **Channel Name** column, enter a meaningful name for each channel. For this example, enter the following names:
  - For analog input channel 0, enter **T Therm** as the channel name.
  - For analog input channel 8, enter **PT1000 RTD** as the channel name.
  - For analog input channel 16, enter **Voltage In** as the channel name.
4. Under the **Sensor** column, select the following sensor types for the analog input channels:
  - For analog input channel 0, select **Type T** as the thermocouple type.
  - For analog input channel 8, select **Euro PT1000** as the RTD type.
  - For analog input channel 16, select **+/-10V** as the input voltage range.
5. Under the **Engineering Units** column, **Deg C** is selected by default. If you want to change this setting, change the temperature units under the **Acquisition** tab.  
*In this example, Deg C is used.*
6. If you know the offset for your calibrated thermocouple and RTD, enter it under the **EU Offset** column. For this example, leave **0** as the EU offset for the thermocouple and RTD channels and **1000** as the EU offset for the voltage input channel.
7. Leave the test point values for each channel unchanged.
8. Click **Close** to close the Channel Configuration dialog box.

## Configure the Parameters of the Acquisition Config Window

For this example, set the Acquisition Config parameters as follows:

1. Click the **Recording** tab.

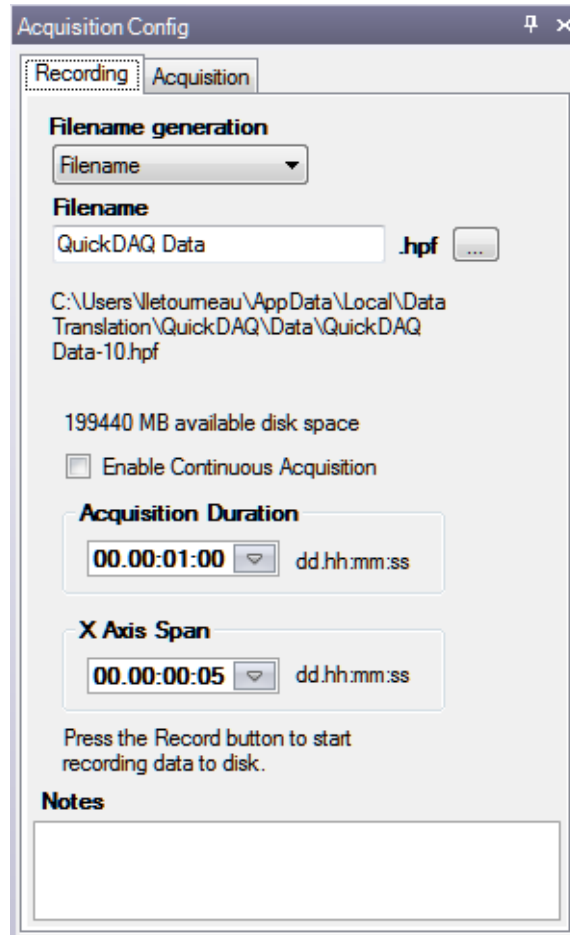

2. For **Filename generation**, select **Filename**.
3. Enter a meaningful name for the data file.  
*In this example, QuickDAQ Data.hpf is used.*
4. Leave the **Enable Continuous Acquisition** checkbox unchecked.
5. For **Acquisition Duration**, select **1 minute** as the time to acquire the measurement data.  
*The amount of available disk space is shown; in addition, the number of scans in the Acquisition Info area is updated based on the acquisition duration that is selected.*
6. For **X Axis Span**, enter **5 seconds** as the span for the x-axis.
7. Click the **Acquisition** tab.

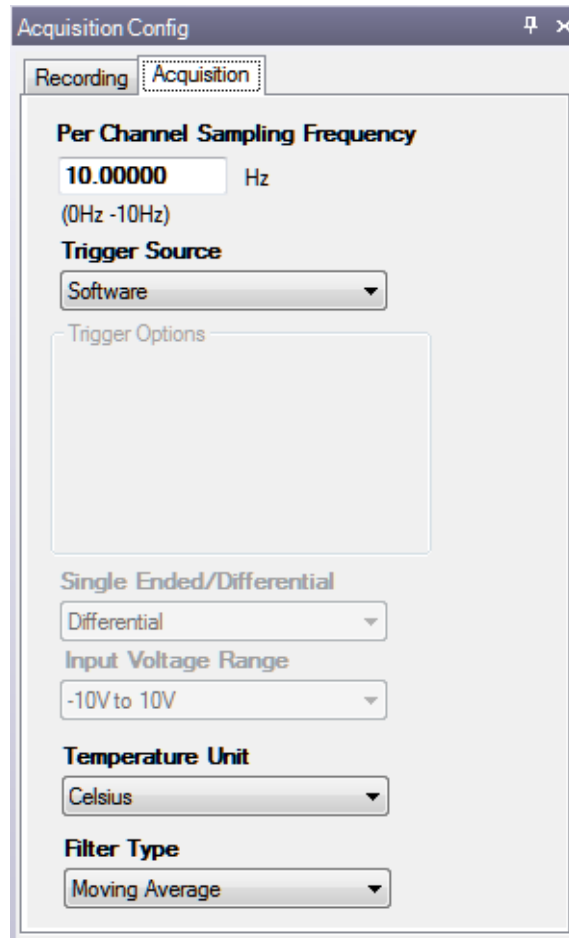

8. For this example, ensure that the following default settings are used:
  - **Sampling Frequency:** 10 Hz
  - **Trigger Source:** Software
  - **Temperature Unit:** Celsius
  - **Filter Type:** Moving Average
9. If desired, hide the **Acquisition Config** window by clicking the **Auto-Hide** pin (  ) in the top, right corner of the window.

## Configure the Appearance of the Channel Display Window

Configure the appearance of the Channel Display window as follows:

1. Ensure that the **Visible Display** column in the **Plot and Data Config** window is checked for all three enabled channels.

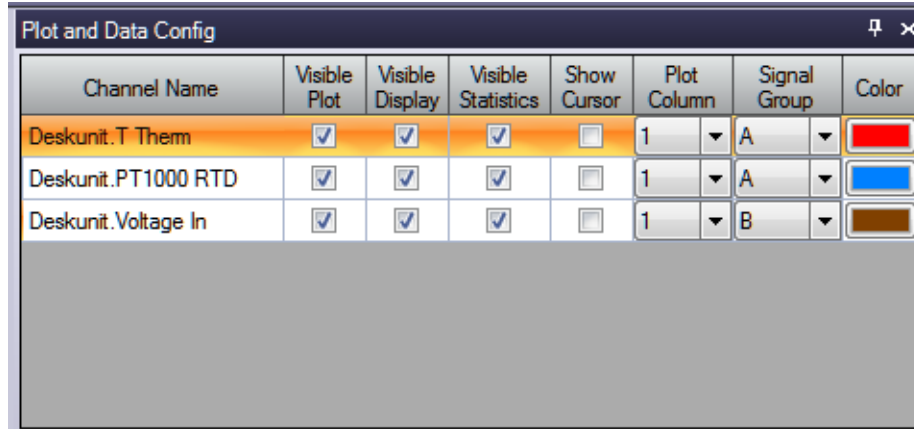

Channel Name	Visible Plot	Visible Display	Visible Statistics	Show Cursor	Plot Column	Signal Group	Color
Deskunit.T Therm	<input checked="" type="checkbox"/>	<input checked="" type="checkbox"/>	<input checked="" type="checkbox"/>	<input type="checkbox"/>	1	A	Red
Deskunit.PT1000 RTD	<input checked="" type="checkbox"/>	<input checked="" type="checkbox"/>	<input checked="" type="checkbox"/>	<input type="checkbox"/>	1	A	Blue
Deskunit.Voltage In	<input checked="" type="checkbox"/>	<input checked="" type="checkbox"/>	<input checked="" type="checkbox"/>	<input type="checkbox"/>	1	B	Brown

2. Click the **Channel Display - Style** tab, and select the color scheme that you want for the Channel Display window.

*In this example, black is used for the background color, green is used for the foreground color, and white is used for the label color.*

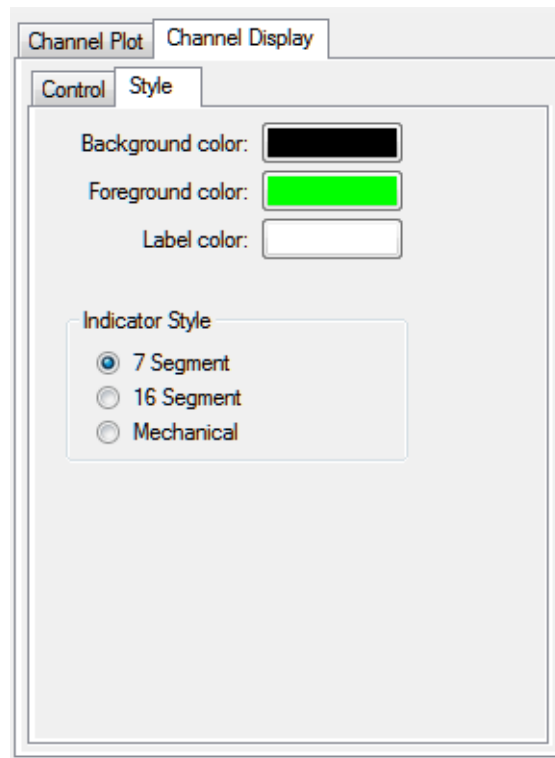

3. Leave the indicator style as **7 segment**.

## Configure the Appearance of the Channel Plot Window

Configure the appearance of the Channel Plot window as follows:

1. In the **Plot and Data Config** window, set up the following parameters:
  - a. Ensure that the **Visible Plot** column is checked for all three enabled channels.
  - b. Leave the **Show Cursor** column unchecked for all three enabled channels.
  - c. Under **Plot Column**, use the default plot column setting of 1 for all three enabled channels.
  - d. Under the **Signal Group** column, select **A** for the thermocouple and RTD channels, and select **B** for the voltage input channel.
  - e. Under the **Color** column, assign a unique color to each trace.

Channel Name	Visible Plot	Visible Display	Visible Statistics	Show Cursor	Plot Column	Signal Group	Color
Deskunit.T Therm	<input checked="" type="checkbox"/>	<input checked="" type="checkbox"/>	<input checked="" type="checkbox"/>	<input type="checkbox"/>	1	A	Red
Deskunit.PT1000 RTD	<input checked="" type="checkbox"/>	<input checked="" type="checkbox"/>	<input checked="" type="checkbox"/>	<input type="checkbox"/>	1	A	Blue
Deskunit.Voltage In	<input checked="" type="checkbox"/>	<input checked="" type="checkbox"/>	<input checked="" type="checkbox"/>	<input type="checkbox"/>	1	B	Brown

2. Click the **Channel Plot - Control** tab, and slide the **Plot height** bar to the left until you can see both plots on the screen at once.

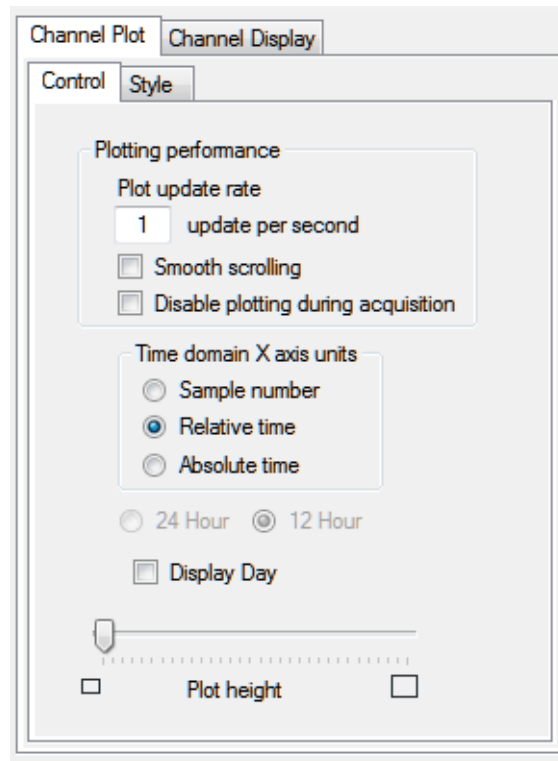

3. Leave the following settings unchanged:
  - **Plot update rate:** 1
  - **Smooth scrolling:** unchecked
  - **Disable during acquisition:** unchecked
  - **Time domain X axis units:** Relative time
  - **Display Days:** unchecked
4. In the display area, click the tab for the **Channel Plot** window.
5. Click the **Show Legend** control (  ) on the toolbar.
6. For the top plot in this window, change the text for the label on the x-axis, by doing the following:
  - a. Right-click on the label.
  - b. Select **Edit Label**.
  - c. Enter the following text: **Thermocouple and RTD Channels**
7. For the bottom plot in this window, change the text for the label on the x-axis, by doing the following:
  - a. Right-click on the label.
  - b. Select **Edit Label**.
  - c. Enter the following text: **Voltage Channels**  
*The Channel Plot window should appear as follows:*

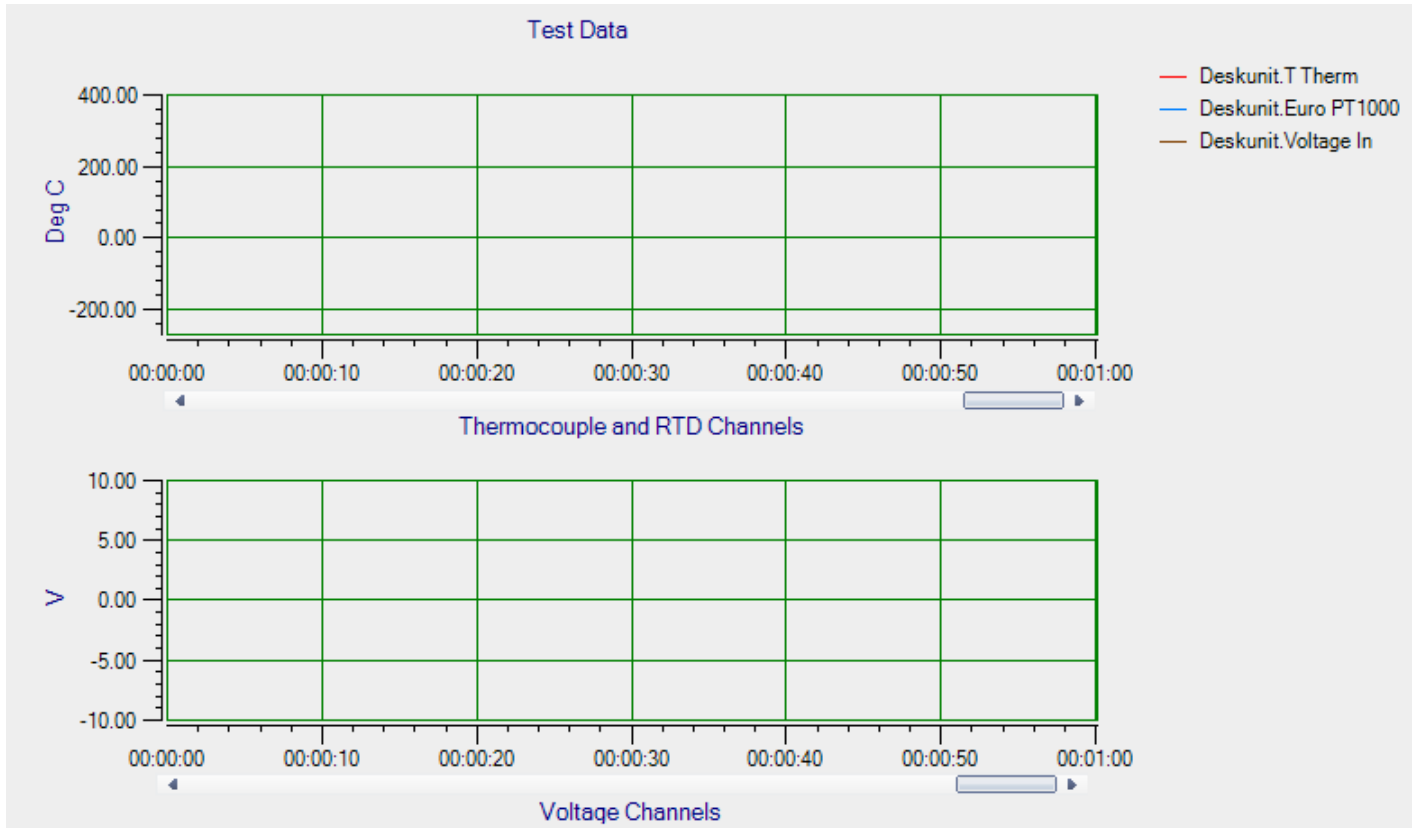

## Configure the Appearance of the Statistics Window

Configure the appearance of the Statistics window as follows:

1. Ensure that the **Visible Statistics** column in the **Plot and Data Config** window is checked for all three enabled channels:

Channel Name	Visible Plot	Visible Display	Visible Statistics	Show Cursor	Plot Column	Signal Group	Color
Deskunit.T Them	<input checked="" type="checkbox"/>	<input checked="" type="checkbox"/>	<input checked="" type="checkbox"/>	<input type="checkbox"/>	1	A	Red
Deskunit.PT1000 RTD	<input checked="" type="checkbox"/>	<input checked="" type="checkbox"/>	<input checked="" type="checkbox"/>	<input type="checkbox"/>	1	A	Blue
Deskunit.Voltage In	<input checked="" type="checkbox"/>	<input checked="" type="checkbox"/>	<input checked="" type="checkbox"/>	<input type="checkbox"/>	1	B	Brown

2. If desired, hide the **Plot and Data Config** window by clicking the **Auto-Hide** pin (  ) in the top, right corner of the window.

## Position the Windows

If you want see the data that is displayed in the Channel Display, Channel Plot, and Statistics windows at once, you need to move the windows to different locations in the display area.

In the following example, the Channel Display window is located at the top of the display area, the Channel Plot window is located in the middle of the display area, and the Statistics window is located at the bottom of the display area:



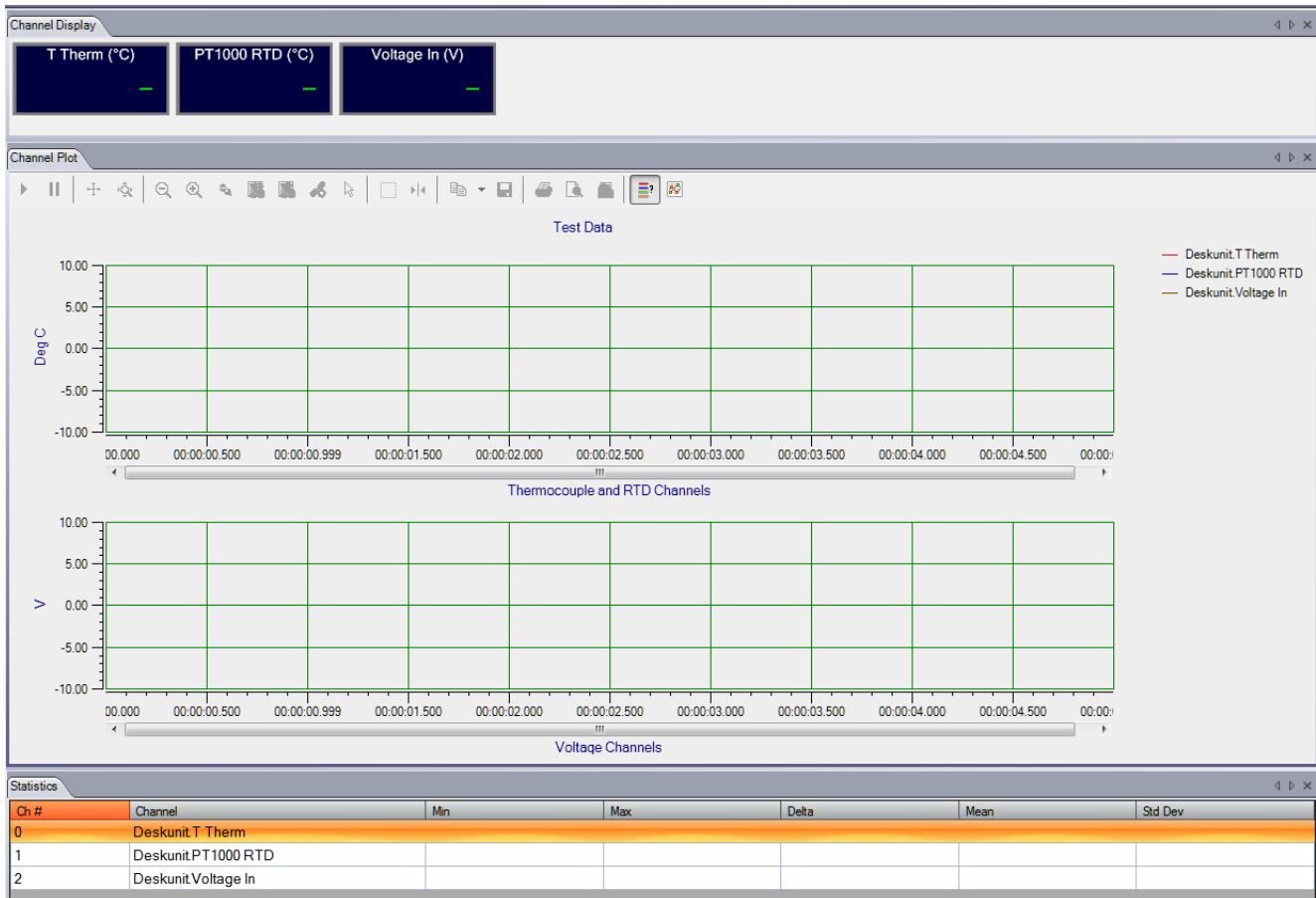

Perform the following steps to position the Channel Display window at the top of the display area, the Channel Plot window in the middle of the display area, and the Statistics window at the bottom of the display area:

1. Click the tab for the **Statistics** window, drag the window toward the middle of the display area, move the mouse over the guide on the bottom of the guide diamond, and then release the mouse button.  
*The Statistics window is now placed at the bottom of the display area.*
2. Click the tab for the **Channel Plot** window, drag the window toward the middle of the display area, move the mouse over the guide on the bottom of the guide diamond, and then release the mouse button.  
*The Channel Plot window is now placed in the middle of the display area, revealing the Channel Display window at the top of the display area.*
3. Resize each window, as desired.

## Start the Measurement

Once you have configured the channels and the display area, start acquisition and log data to disk by clicking the **Record** toolbar button (  ).

Results similar to the following are displayed in the display area.

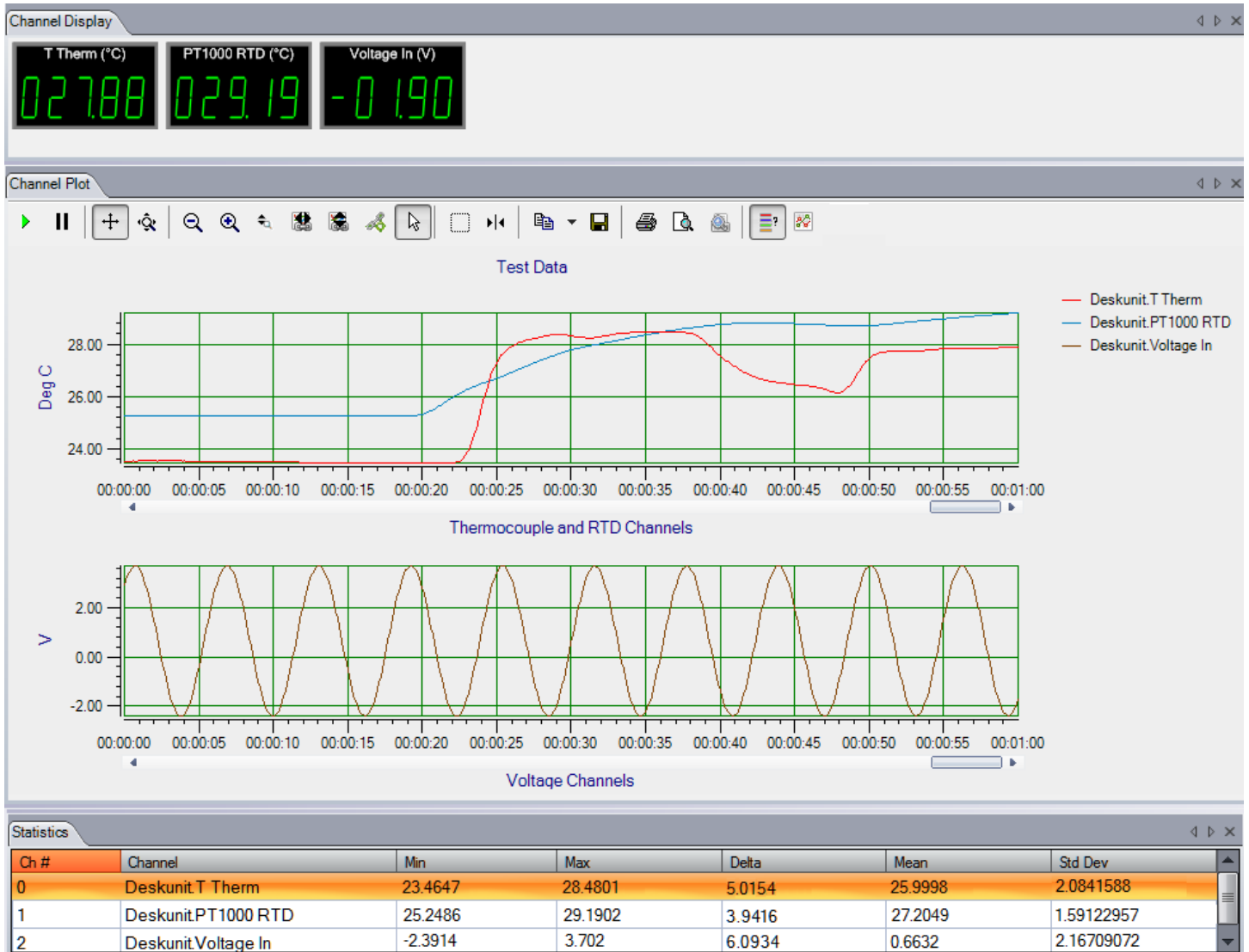

If desired, you can view the data in Excel by clicking the **Open Current Data in Excel** toolbar button (  ).

## ***Example of Monitoring an Analog Output Signal***

The following steps describe how to use the Data Logger interface of QuickDAQ to monitor the output of an analog output signal of a device using one of its analog input channels.

In this example, a 3 V sine wave is output on analog output channel 0 of a DT9837C module. The analog output channel is connected to analog input channel 0 on the DT9837C module.

### **Configure the Analog Output Settings**

For this example, configure the analog output channel as follows:

1. Click the **Output** tab of the Acquisition Config window.

Recording	Acquisition	Output		
Enable	Channel Name	Waveform	Peak Voltage	Offset
<input checked="" type="checkbox"/>	DT9837-C(00...	Fixed	3	0

**Waveform**

**Signal Type**  
Sine

**Frequency**  
100.00 Hz

**Output Mode**  
Continuous

Repeat burst

**Options**

**Burst On Time**  
1.0000 Sec

**Burst Off Time**  
0.00000 Sec

Lock to acquisition time

**Ramp Up Time**  
0.00000 Sec

**Ramp Down Time**  
0.00000 Sec

**Start/Stop Method**  
With Acquisition

**Trigger Source**  
Software

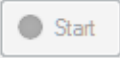

2. Select the **Enable** checkbox to enable the analog output channel on the module.
3. For the **Waveform** type, select **Fixed**.
4. For **Peak Voltage**, enter 3 to output a  $\pm 3$  V signal.

5. For **Offset**, enter 0.
6. For **Signal Type**, select **Sine** to output a sine wave.
7. For **Output Mode**, select **Continuous** to output a waveform that repeats continuously.
8. For **Frequency**, select **100 Hz**; this is the frequency of the output waveform.
9. For **Ramp Up Time**, enter 0.
10. For the **Start/Stop Method**, select **With Acquisition**.  
*The analog output operation will start when you start acquisition.*
11. If desired, hide the Acquisition Config window by clicking the Auto-Hide pin (  ) in the top, right corner of the window.

## Configure the Analog Input Channel

Configure the analog input channel as follows:

1. Ensure that the output from analog output channel 0 is connected to the input of analog input channel 0.
2. Configure the analog input channel by clicking the **Input Channel Configuration** toolbar button (  ) or by clicking the **Configuration** menu and clicking **Input Channel Configuration**.
3. Enable analog input channel 0 by clicking the **Enable** checkbox next to the channel.

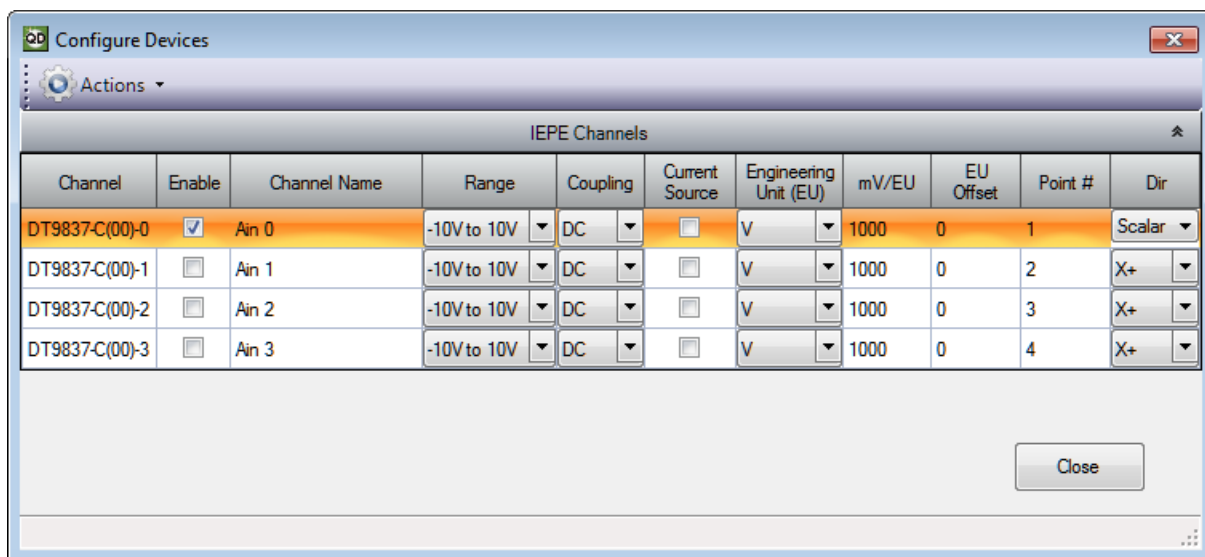

4. Under the **Channel Name** column, leave the default channel name as Ain 0.
5. Under the **Range** column, select the input range for analog input channel.  
*In this example,  $\pm 10$  V is used.*
6. Under the **Coupling** column, select the coupling type (AC or DC) for your sensor.  
*Since this example is monitoring a voltage input, DC is used.*

7. Under the **Current Source** column, select whether to enable or disable use of the current source on the data acquisition device.  
*Since this example is monitoring a voltage input, the **Current Source** checkbox is not checked (disabled) for the analog input channel.*
8. Under the **Engineering Units** column, select the engineering units for the input.  
*In this example, **V** is used.*
9. Enter the number of mV per engineering unit in the **mV/EU** field.  
*In this example, **1000** is used.*
10. If an offset is specified for the input, enter the value in the **EU Offset** field.  
*In this example, no offset (**0**) is specified.*
11. If desired, enter a test point value for the channel.  
*In this example, **0** is used.*
12. If desired, enter a sensor direction for each channel.  
*In this example, **Scalar** is used.*
13. Click **Close** to close the Configure Devices dialog box.

## Configure the Recording Settings

For this example, configure the recording settings as follows:

1. Click the **Recording** tab of the Acquisition Config window.

The screenshot shows the 'Recording' tab of the Acquisition Config window. It features three tabs: 'Recording', 'Acquisition', and 'Output'. The 'Recording' tab is active. The 'Filename generation' section includes a dropdown menu for 'Filename', a text field containing 'QuickDAQ Data', a file extension '.hpf', and a browse button '...'. Below this, the full file path is displayed: 'C:\Users\Nletoumeau\AppData\Local\Data Translation\QuickDAQ\Data\QuickDAQ Data.hpf'. A status indicator shows '202520 MB available disk space'. There is an unchecked checkbox for 'Enable Continuous Acquisition'. The 'Acquisition Duration' section has a dropdown menu set to '00:00:00:10' and a label 'dd.hh:mm:ss'. The 'X Axis Span' section has a dropdown menu set to '00:00:00:06' and a label 'dd.hh:mm:ss'. A note at the bottom of the tab reads: 'Press the Record button to start recording data to disk.' At the very bottom, there is a 'Notes' section with an empty text area.

Recording Acquisition Output

**Filename generation**

Filename

Filename

QuickDAQ Data .hpf ...

C:\Users\Nletoumeau\AppData\Local\Data Translation\QuickDAQ\Data\QuickDAQ Data.hpf

202520 MB available disk space

Enable Continuous Acquisition

**Acquisition Duration**

00:00:00:10 dd.hh:mm:ss

**X Axis Span**

00:00:00:06 dd.hh:mm:ss

Press the Record button to start recording data to disk.

**Notes**

2. For **Filename generation**, use the **Filename** option.
3. For **Filename**, use the default name for the data file.
4. Leave the **Enable Continuous Acquisition** checkbox unchecked.
5. For **Acquisition Duration**, select **10 Seconds** as the time to acquire data.

## Configure the Acquisition Settings

For this example, configure the acquisition settings as follows:

1. Click the **Acquisition** tab of the Acquisition Config window.

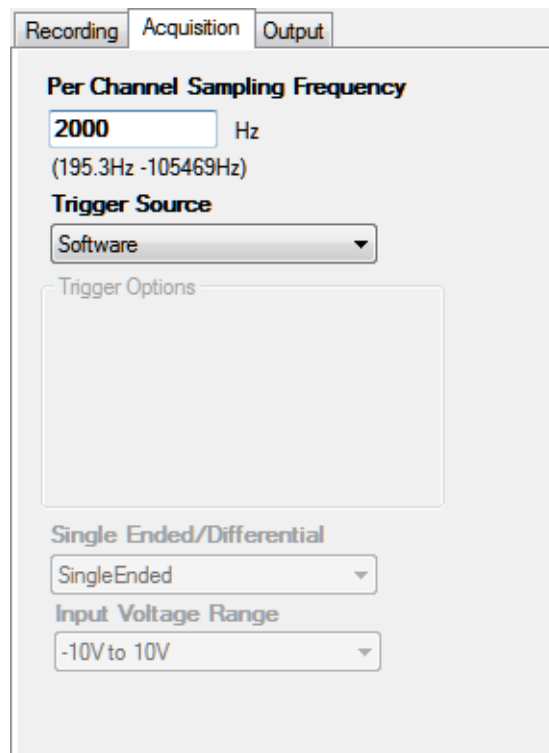

2. In the **Maximum frequency to analyze** text box, enter **2000** as the bandwidth or span, in Hz, of the input signals that you want to analyze  
*Internally, the sampling rate of the data acquisition device is set to twice the bandwidth, or 4000 Hz in this example.*
3. For the **Trigger Source**, select **Software** to ensure that the measurement starts as soon as the **Record** button is clicked.
4. If desired, hide the Acquisition Config window by clicking the Auto-Hide pin (  ) in the top, right corner of the window.



## Configure the Appearance of the Display

In the Plot and Data Config window, ensure that the **Visible Plot** checkbox is checked.

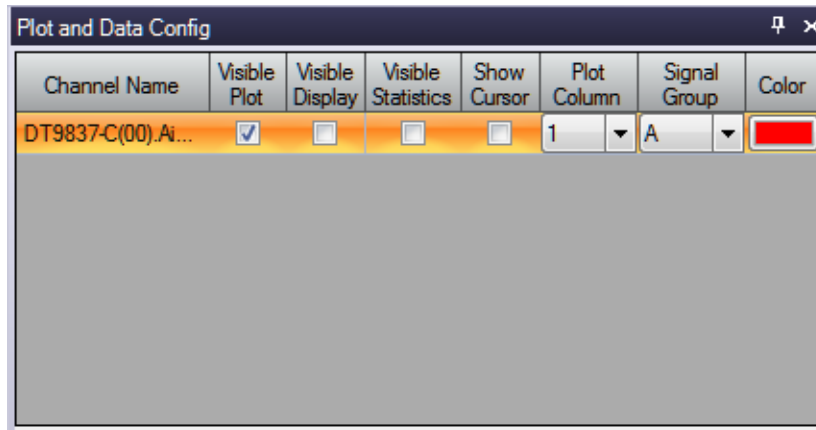

## Start the Operation

Once you have configured the channels and the application parameters, click the **Record** toolbar button (  **Record** ) or press the **F5** key to start the operation.

Results similar to the following are displayed in the Channel Plot window, showing the output of analog output channel 0 as measured by analog input channel 0.

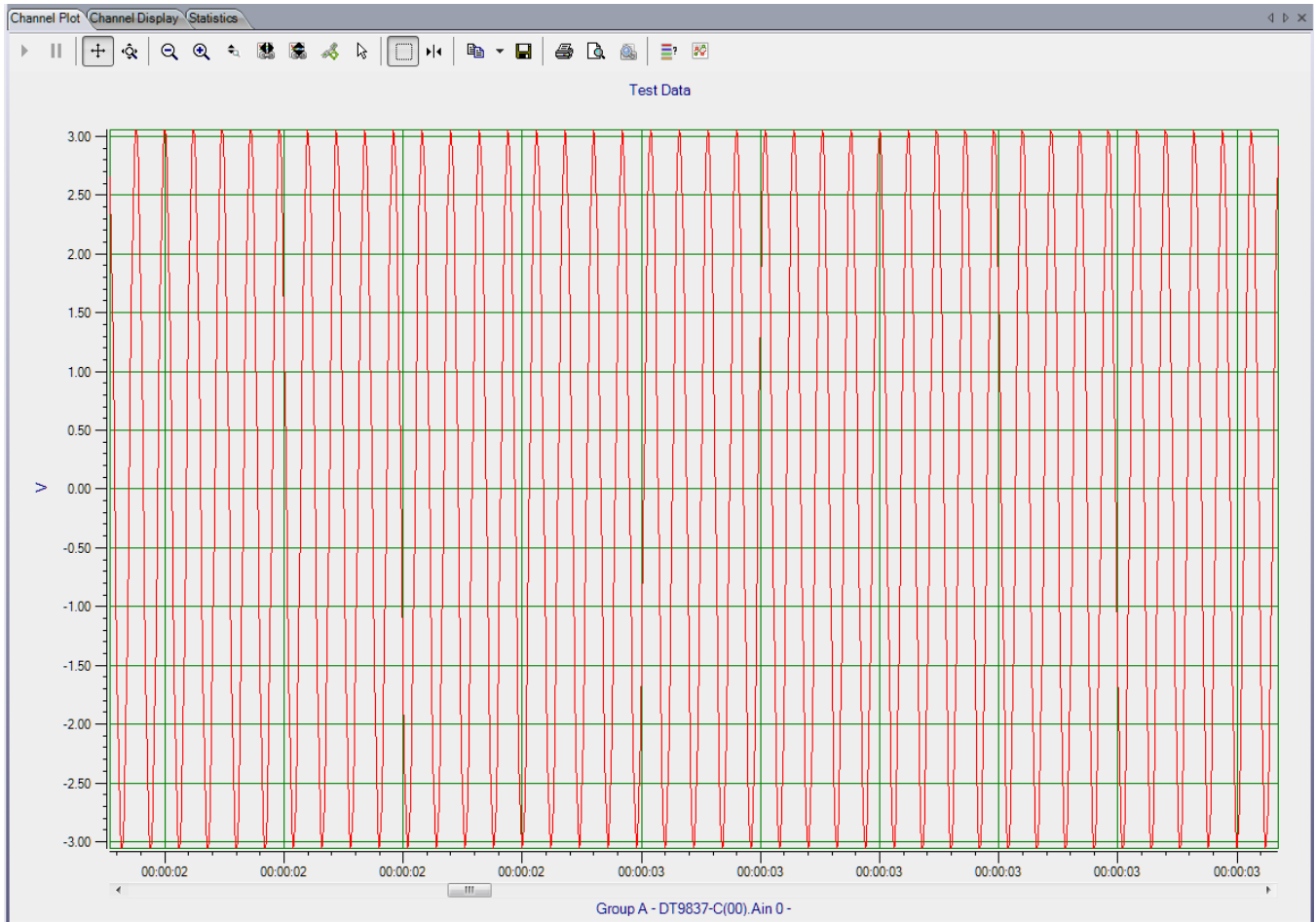



## ***Examples Using the FFT Analyzer Interface***

Acceleration Measurement Example.....	268
Impact Testing Example .....	283
Strain Gage Example .....	303
Bridge-Based Sensor Example .....	316
Free Run Swept Sine Example .....	329
Triggered Burst Random Example.....	347
Example of Monitoring an Analog Output Signal .....	366
Example of Using a Digital Filter.....	377



## Acceleration Measurement Example

If you are using the FFT Analysis option or Advanced FFT Analysis option of QuickDAQ, you can use the following steps to perform an acceleration measurement.

This example uses a triaxial accelerometer connected to a DT9837C module to measure the vibration of a fan with an unbalanced blade. The FFT Analyzer interface of QuickDAQ is used.

### Configure the Channels

Configure the channels as follows:

1. Ensure that the accelerometer is connected to your data acquisition device. For a triaxial accelerometer, each axis should be connected to a unique analog input channel.  
*In this example, the x-axis connector is attached to analog input channel 0, the y-axis connector is attached to analog input channel 1, and the z-axis connector is attached to analog input channel 2 of a DT9837C module.*
2. Configure each analog input channel by clicking the **Input Channel Configuration** toolbar button (  ) or by clicking the **Configuration** menu and clicking **Input Channel Configuration**.
3. Enable analog input channels 0, 1, and 2 at once by highlighting these analog input channels, clicking the **multi-channel Actions** button (  **Actions** ▾ ), and clicking **Enable all Selected Channels**. Alternatively, you can enable the channels by clicking the **Enable** checkbox for each of these channels.  
*In this example, analog input channels 0, 1, and 2 are enabled.*

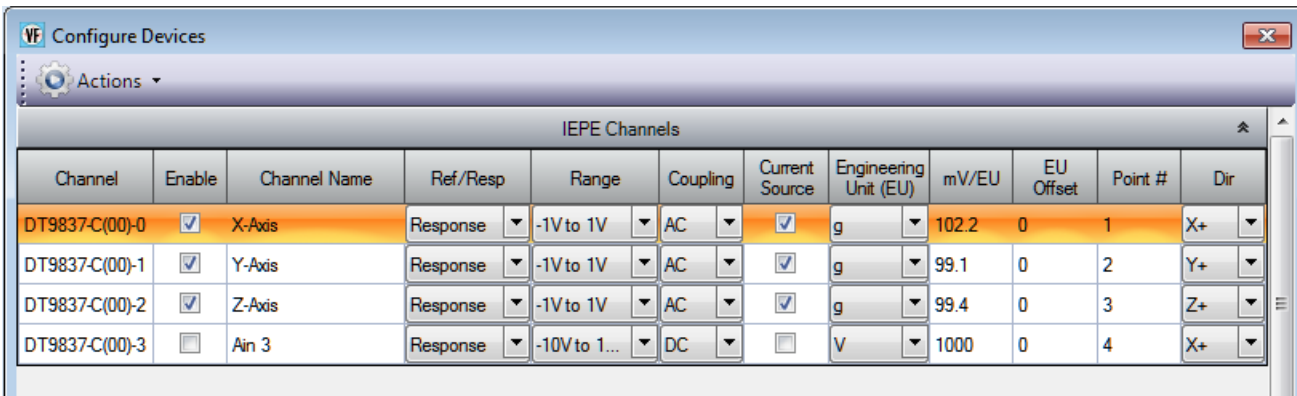

Channel	Enable	Channel Name	Ref/Resp	Range	Coupling	Current Source	Engineering Unit (EU)	mV/EU	EU Offset	Point #	Dir
DT9837-C(00)-0	<input checked="" type="checkbox"/>	X-Axis	Response	-1V to 1V	AC	<input checked="" type="checkbox"/>	g	102.2	0	1	X+
DT9837-C(00)-1	<input checked="" type="checkbox"/>	Y-Axis	Response	-1V to 1V	AC	<input checked="" type="checkbox"/>	g	99.1	0	2	Y+
DT9837-C(00)-2	<input checked="" type="checkbox"/>	Z-Axis	Response	-1V to 1V	AC	<input checked="" type="checkbox"/>	g	99.4	0	3	Z+
DT9837-C(00)-3	<input type="checkbox"/>	Ain 3	Response	-10V to 1...	DC	<input type="checkbox"/>	V	1000	0	4	X+

4. Under the **Channel Name** column, enter the following names for the analog input channels:
  - For analog input channel 0, enter **X-Axis**.
  - For analog input channel 1, enter **Y-Axis**.
  - For analog input channel 2, enter **Z-Axis**.
5. Under the **Ref/Resp** column, select **Response** for the analog input channels.

6. Under the **Range** column, select the best effective input range ( $\pm 10$  V or  $\pm 1$  V) for each signal. For example, if your accelerometer measures 100 mV/g and your signal of interest is less than 100 g, choose the  $\pm 1$  V range; similarly, if your signal of interest is greater than 100 g, choose the  $\pm 10$  V range.  
*In this example,  $\pm 1$  V is used.*
7. Under the **Coupling** column, select the coupling type (AC or DC) for your sensor. For most IEPE accelerometers, you will want to choose **AC** coupling to remove any DC offset from your measurement. Choose **DC** coupling only if the signal source has no offset voltage or if the DC content of the acquired signal is important.  
*In this example, AC is used.*
8. Under the **Current Source** column, select whether to enable or disable use of the 4 mA current source on the data acquisition device. Since most IEPE accelerometers require a current source of 4 mA and a compliance voltage of at least 18 V to drive their internal circuitry, in most cases, you will want to enable use of the current source for each analog input channel.  
*In this example, the **Current Source** checkbox is checked (enabled) for all three analog input channels.*

---

**Note:** If you enable the use of the internal 4 mA excitation current source, it is recommended that you choose AC coupling.

---

9. Under the **Engineering Units** column, select the engineering units for the accelerometer.  
*In this example, g is used.*
10. Using the calibration certificate that was supplied with your accelerometer, enter the calibrated sensitivity for the axis that is connected to the selected analog input channel in the **mV/EU** field. In this example, the following values are used:
  - Analog input channel 0 (X-Axis) = 102.2 mV/g
  - Analog input channel 1 (Y-Axis) = 99.1 mV/g
  - Analog input channel 2 (Z-Axis) = 99.4 mV/g
11. If an offset is specified for the accelerometer, enter the value in the **EU Offset** field.  
*In this example, no offset (0) is specified.*
12. If desired, enter a test point value for each channel. In this example, the following values are used:
  - Analog input channel 0 (X-Axis) = 1
  - Analog input channel 1 (Y-Axis) = 2
  - Analog input channel 2 (Z-Axis) = 3
13. If desired, enter a sensor direction for each channel. In this example, the following values are used:
  - Analog input channel 0 (X-Axis) = X+
  - Analog input channel 1 (Y-Axis) = Y+
  - Analog input channel 2 (Z-Axis) = Z+
14. Click **Close** to close the Configure Devices dialog box.

## Configure the Recording Settings

For this example, configure the recording settings as follows:

1. Click the **Recording** tab of the Acquisition Config window.

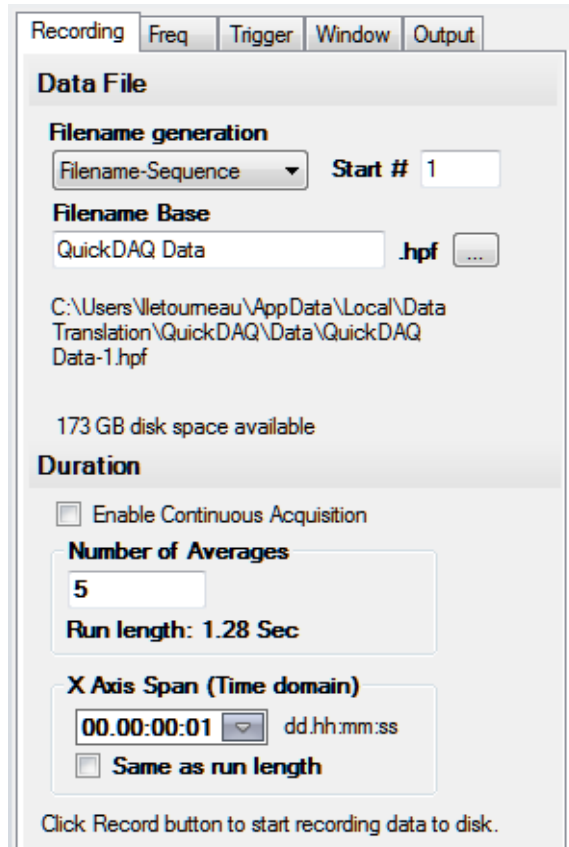

The screenshot shows the 'Recording' configuration window with the following settings:

- Recording** tab selected.
- Data File** section:
  - Filename generation:** Dropdown set to 'Filename-Sequence', **Start #** is 1.
  - Filename Base:** Text field contains 'QuickDAQ Data', file type is '.hpf'.
  - Path: C:\Users\Nletoumeau\AppData\Local\Data Translation\QuickDAQ\Data\QuickDAQ Data-1.hpf
  - 173 GB disk space available
- Duration** section:
  - Enable Continuous Acquisition (unchecked)
  - Number of Averages:** Text field contains 5
  - Run length:** 1.28 Sec
  - X Axis Span (Time domain):** Text field contains 00:00:00:01, dropdown menu, and format dd.hh:mm:ss
  - Same as run length (unchecked)
- Bottom note: Click Record button to start recording data to disk.

2. For **Filename generation**, use the **Filename** option.
3. For **Filename**, use the default name for the data file.
4. Leave the **Enable Continuous Acquisition** checkbox unchecked.
5. For **Number of Averages**, enter 5 as the number of records to acquired, process, and average before acquisition stops.  
*The number of seconds for the total run and the amount of available disk space are shown.*
6. Select the span you want to use for the time-domain data on the x-axis.

## Configure the Frequency Settings

Configure the frequency settings as follows:

1. Click the **Freq** tab of the Acquisition Config window.

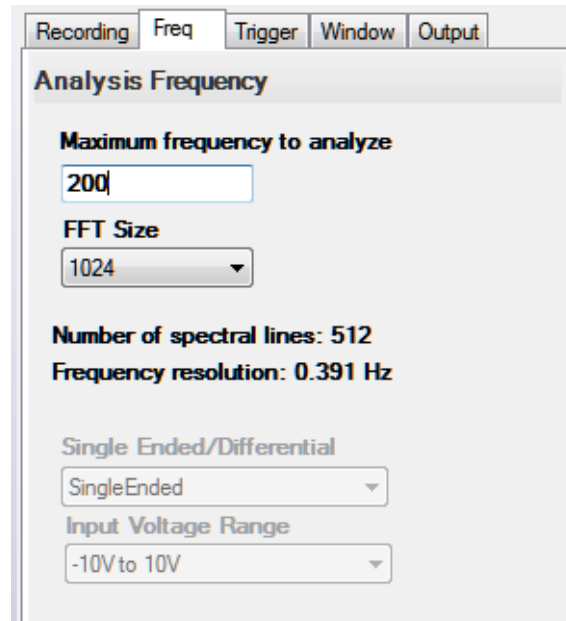

2. In the **Maximum frequency to analyze** text box, enter **200** as the bandwidth or span, in Hz, of the input signals that you want to analyze  
*Internally, the sampling rate of the data acquisition device is set to twice the bandwidth, or 400 Hz in this example.*
3. In the **FFT Size** text box, select **1024** from the drop-down combo box as the number of data points to use for the FFT calculation.  
*The number of spectral lines and the frequency resolution are displayed.*

## Configure the Trigger Settings

For this example, configure the trigger settings as follows:

1. Click the **Trigger** tab of the Acquisition Config window.

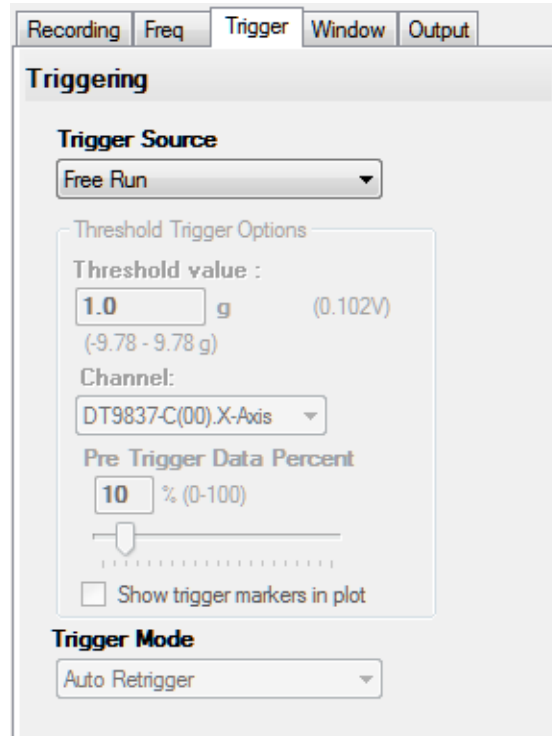

2. For the **Trigger Source**, select **Free Run** to ensure that the measurement starts as soon as the **Record** button is clicked.  
*In this mode, the Trigger Mode is not used.*



## Configure the Windowing Function

For this example, configure the windowing function as follows:

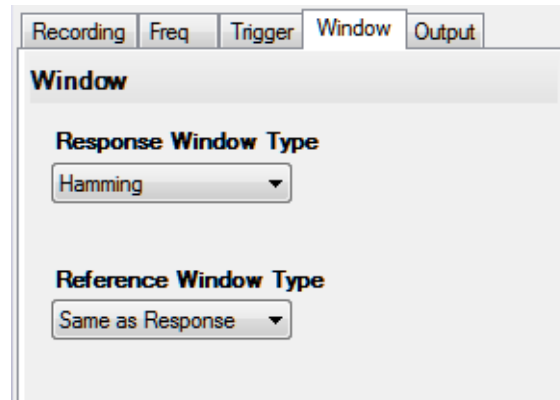

1. Click the **Window** tab of the Acquisition and Config window.  
*The Window tab for the Advanced FFT Analysis option of QuickDAQ is shown. Note that the FFT Analysis option of QuickDAQ does not use response and reference terms, and does not provide the reference window selections.*



2. For the **Response Window Type** (Advanced FFT Analysis option) or **Window Type** (FFT Analysis option), select **Hamming**.  
*This is a setting is applied to the FFTs for all enabled analog input channels.*
3. If you are using the Advanced FFT Analysis option, leave the setting for the **Reference Window Type** as **Same As Response**.  
*This example does not use reference channels.*
4. If desired, hide the Acquisition Config window by clicking the Auto-Hide pin (  ) in the top, right corner of the window.

## Add FFTs Channel to the Channel Plot Window

The following steps show how to use the FFT Analyzer interface of QuickDAQ to add an FFT channel for each enabled analog input channel to the Channel Plot window:

1. Click the **Add single channel FFT function** (  ) button, and select the channel named **DT9837-C(00).X-Axis**.
2. Click the **Add single channel FFT function** (  ) button, and select the channel named **DT9837-C(00s).Y-Axis**.
3. Click the **Add single channel FFT function** (  ) button, and select the channel named **DT9837-C(00).Z-Axis**.

By default, these channels are visible in the Channel Plot window.

## Configure FFT Parameters to Analyze Acceleration Data

The following steps show how to use the FFT Analyzer interface of QuickDAQ to configure the parameters used to generate the FFTs for each analog input channel:

1. Under the **Channel Name** column in the Plot and Data Config window, hold down the **Ctrl** key and select the three FFT channels (**DT9837-C(00).X-Axis-FFT**, **DT9837-C(00).Y-Axis-FFT**, and **DT9837-C(00).Z-Axis-FFT**) to configure the settings the same way for all three channels.
2. Click the **Data** tab, and then click the **Function** tab.

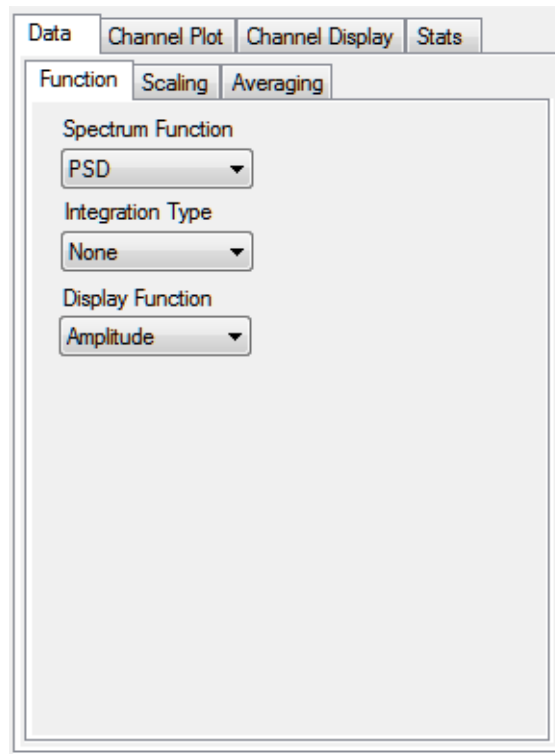

3. For this example, configure the settings of this tab as follows:
  - a. For **Spectrum Function**, select **PSD** (Power Spectral Density).
  - b. For **Integration Type**, select **None** for acceleration data.
  - c. For **Display Function**, select **Amplitude**.
4. Click the **Scaling** tab.

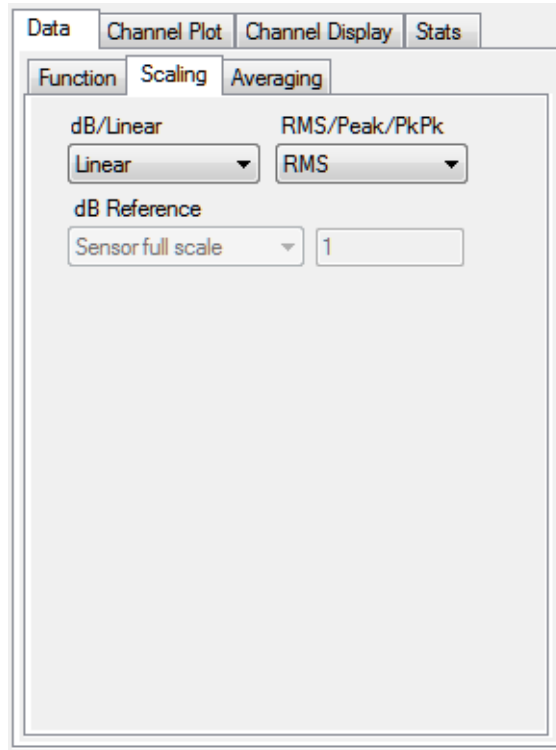

5. For this example, configure the settings of this tab as follows:
  - a. For **dB/Linear**, select **Linear**.
  - b. For **RMS/Peak/PkPk**, select **RMS**.
6. Click the **Averaging** tab.

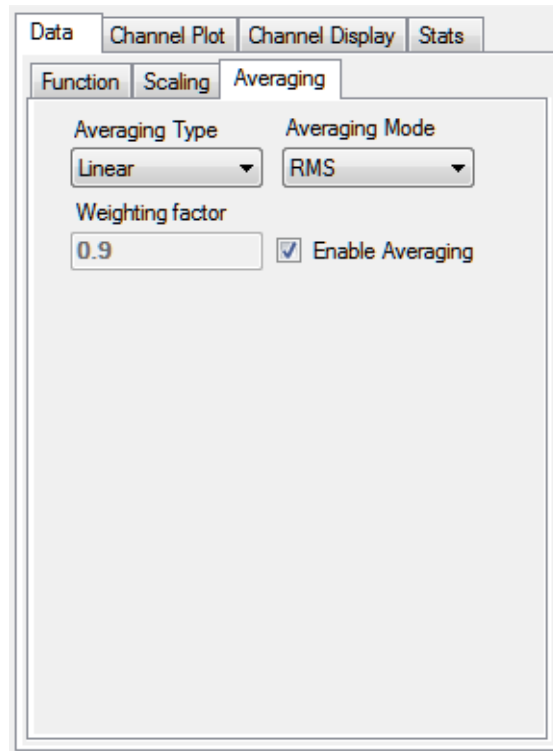



7. For this example, configure the settings of this tab as follows:
  - a. Check the **Enable Averaging** checkbox.
  - b. For **Averaging Type**, select **Linear**.
  - c. For **Averaging Mode**, select **RMS**.

## Configure the Appearance of the Channel Plot Window

Because, in this example, we want to look at data from three analog input channels, as well as their corresponding FFTs, in one view without scrolling, perform the following steps to configure the appearance of the Channel Plot window:

1. Under the **Plot Column** heading, assign the analog input channels to plot column 1, and assign the FFT channels to plot column 2, as follows:
  - a. Leave the analog input channels unchanged with the default plot column setting of 1.
  - b. Hold down the Ctrl key and select all the FFT channels.
  - c. Click the **Multi-channel Actions** button (  Actions ▾ ).
  - d. Click **Select channels Plot Column**.
  - e. Select 2 as the column number to change the plot column for all FFT channels at once.

Channel Name	Visible Plot	Visible Display	Visible Statistics	Show Cursor	Plot Column	Signal Group	Color
DT9837-C(00).X-Axis	<input checked="" type="checkbox"/>	<input checked="" type="checkbox"/>	<input type="checkbox"/>	<input type="checkbox"/>	1	None	Red
DT9837-C(00).X-Axis-FFT	<input checked="" type="checkbox"/>		<input type="checkbox"/>	<input type="checkbox"/>	2	None	Blue
DT9837-C(00).Y-Axis	<input checked="" type="checkbox"/>	<input checked="" type="checkbox"/>	<input type="checkbox"/>	<input type="checkbox"/>	1	None	Green
DT9837-C(00).Y-Axis-FFT	<input checked="" type="checkbox"/>		<input type="checkbox"/>	<input type="checkbox"/>	2	None	Orange
DT9837-C(00).Z-Axis	<input checked="" type="checkbox"/>	<input checked="" type="checkbox"/>	<input type="checkbox"/>	<input type="checkbox"/>	1	None	Brown
DT9837-C(00).Z-Axis-FFT	<input checked="" type="checkbox"/>		<input type="checkbox"/>	<input type="checkbox"/>	2	None	Pink

- Assign a unique color to each trace, if desired.
- Click the **Channel Plot - Control** tab.

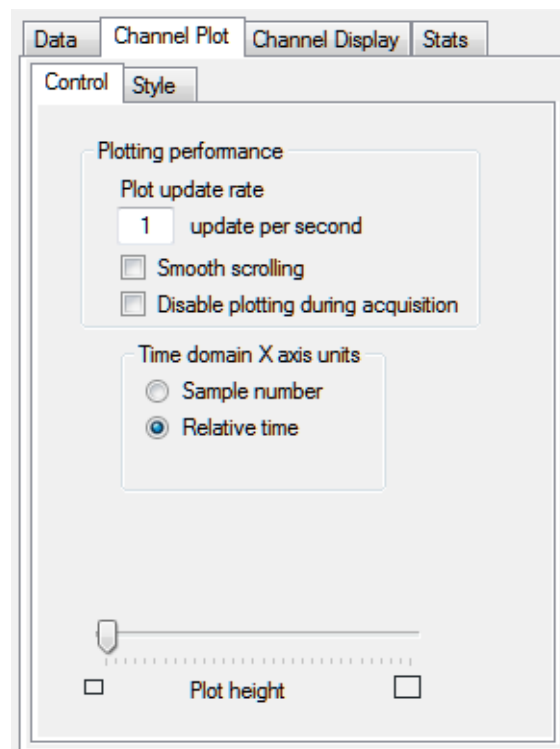

- Slide the **Plot height** bar to the left until you can see all 6 plots on the screen at once.

## Configure Statistics to Analyze Acceleration Data

The following steps show how to use the FFT Analyzer interface of QuickDAQ to configure FFT statistics that are useful when analyzing acceleration data:

1. Click the **Stats** tab.

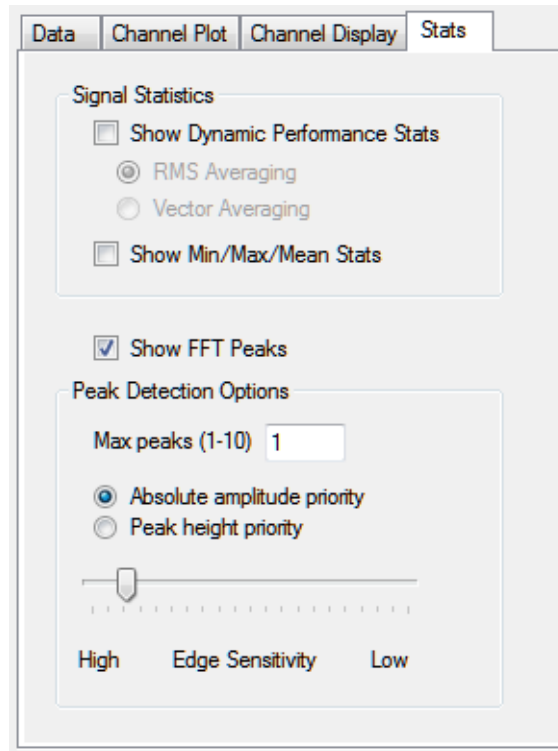

2. For this example, check the **Show FFT Peaks** checkbox to show a graphic similar to the following next to each FFT plot:

#	Freq	Val
1	45.3	1.038

3. For **Max peaks to detect**, select 1.
4. For **Priority**, select **Absolute amplitude**.
5. For **Edge sensitivity**, slide the bar to the left for the most edge sensitivity (this will help ensure that the most peaks are detected).
6. If desired, hide the **Plot and Data Config** window by clicking the Auto-Hide pin (  ) in the top, right corner of the window.

## Start the Acceleration Measurement

Once you have configured the channels and the parameters for the Channel Plot window, start acquisition and log data to disk by clicking the **Record** toolbar button (  Record ). Results similar to the following are displayed in the Channel Plot window.

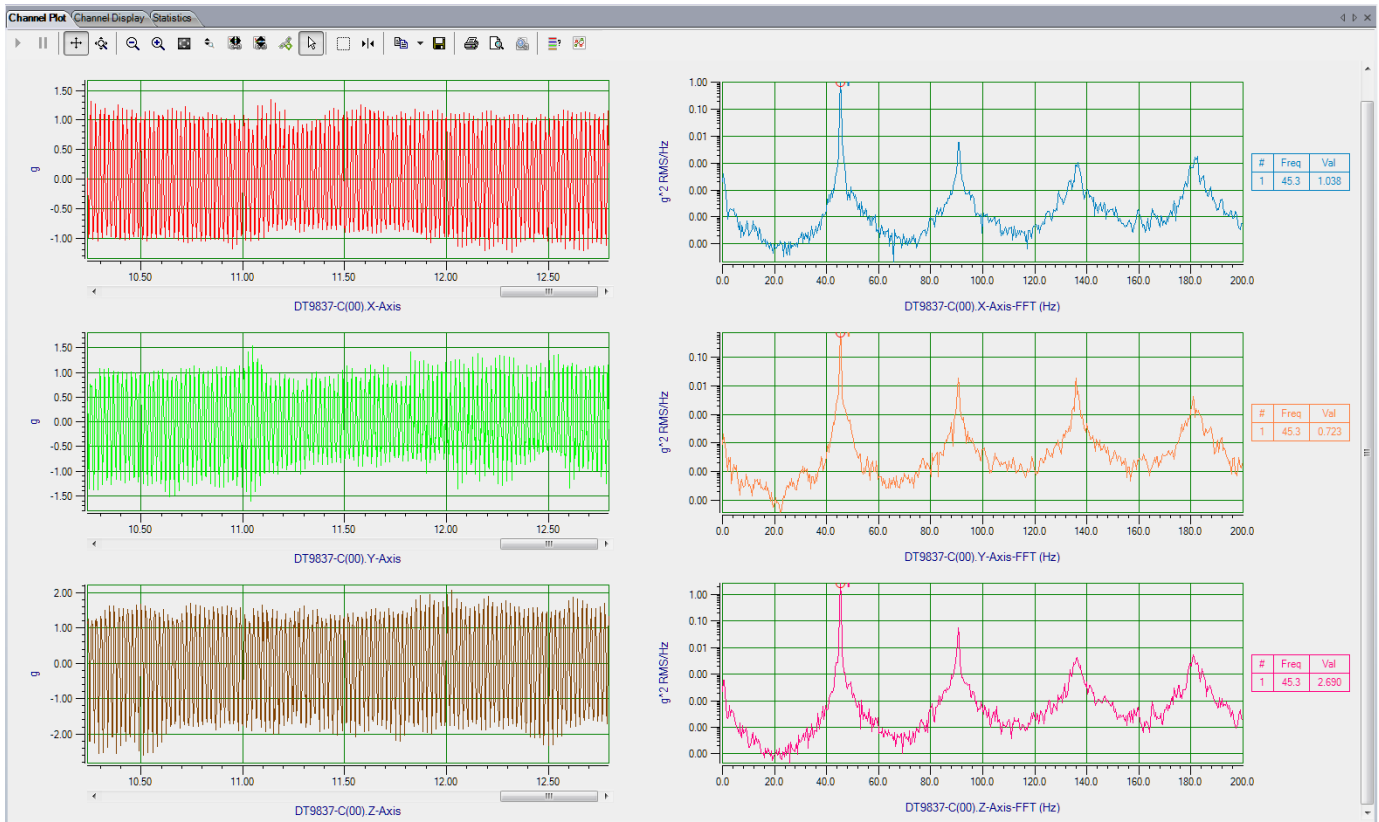

## Perform Further Analysis of the Data

Once you have logged data to disk, you can modify the parameters of the Plot and Data Config window to perform further data analysis. An example follows:

1. If you hid the Plot and Data Config window previously, show the window by hovering over the **Plot and Data Config** tab with the mouse and then clicking the **Auto-Hide** pin (  ) in the top, right corner of the window.
2. Ensure that the **Auto-reprocess on parameter change** checkbox is checked.
3. Click the **Stats** tab, and uncheck the **Show FFT Peaks** checkbox.  
*Notice the change to the Channel Plot window takes effect immediately.*
4. Under the **Channel Name** column, click the FFT channel to modify (for example, **DT9837-C(00).X-Axis-FFT**).
5. Click the **Data** tab, and then click the **Function** tab.

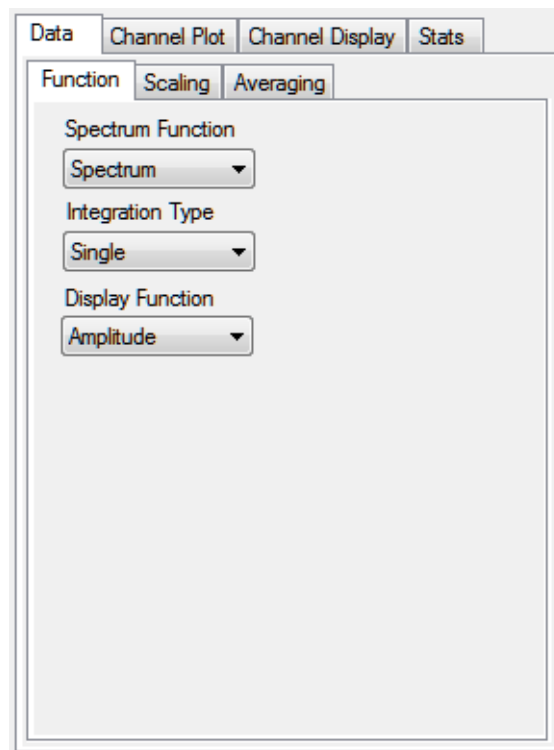

6. For this example, configure the settings of this tab as follows:
  - a. For **Spectrum Function**, select **Spectrum**.
  - b. For **Integration Type**, select **Single** for velocity data.
  - c. For **Display Function**, leave **Amplitude** selected.



7. Click the **Scaling** tab.

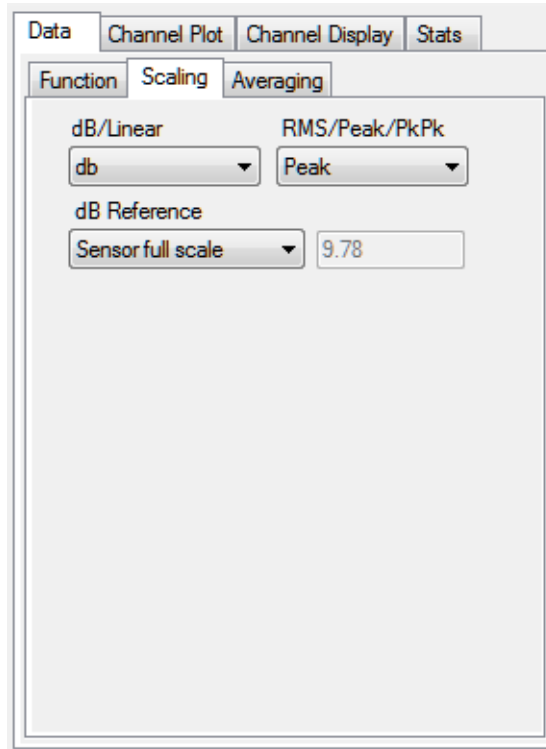

8. For this example, configure the settings of this tab as follows:
  - a. For **dB/Linear**, select **db**.
  - b. For **RMS/Peak/PkPk**, select **Peak**.
  - c. Leave the other settings unchanged.

9. Add a data-cursor to the plot, as follows:

- a. Under the **Show Cursor** column, click the checkbox next to the FFT channel for analog input channel 0 (in this example, **DT9837-C(00).X-Axis-FFT**).  
A data cursor appears on the FFT plot for that channel. (Note that you can remove the data cursor later, if desired, by unchecking this checkbox.)

Channel Name	Visible Plot	Visible Display	Visible Statistics	Show Cursor	Plot Column	Signal Group	Color
DT9837-C(00).X-Axis	<input checked="" type="checkbox"/>	<input checked="" type="checkbox"/>	<input type="checkbox"/>	<input type="checkbox"/>	1	None	Red
DT9837-C(00).X-Axis-FFT	<input checked="" type="checkbox"/>	<input checked="" type="checkbox"/>	<input type="checkbox"/>	<input checked="" type="checkbox"/>	2	None	Blue
DT9837-C(00).Y-Axis	<input checked="" type="checkbox"/>	<input checked="" type="checkbox"/>	<input type="checkbox"/>	<input type="checkbox"/>	1	None	Green
DT9837-C(00).Y-Axis-FFT	<input checked="" type="checkbox"/>	<input checked="" type="checkbox"/>	<input type="checkbox"/>	<input type="checkbox"/>	2	None	Orange
DT9837-C(00).Z-Axis	<input checked="" type="checkbox"/>	<input checked="" type="checkbox"/>	<input type="checkbox"/>	<input type="checkbox"/>	1	None	Brown
DT9837-C(00).Z-Axis-FFT	<input checked="" type="checkbox"/>	<input checked="" type="checkbox"/>	<input type="checkbox"/>	<input type="checkbox"/>	2	None	Pink

- b. Click the data-cursor control (  ) at the top of the Channel Plot window.
- c. Right-click on the data cursor on the Channel Plot window, select **Color**, and change the color of the data cursor to red.
- d. Move the position of a data-cursor on the plot by holding down the left mouse button and dragging the mouse.

The values of the selected points are shown; an example follows:

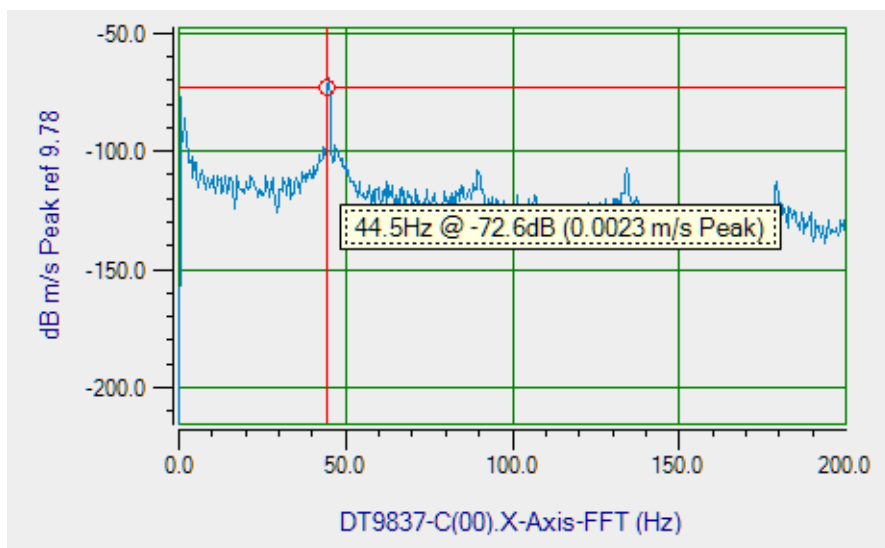

Notice that, in this example, the velocity is 0.0023 m/s for the highlighted peak.

10. If desired, modify the other parameters of the Plot and Data Config window as you wish, and view the results.

## Impact Testing Example

If you are using the Advanced FFT Analysis option of QuickDAQ, you can use the following steps to perform an impact test.

This example uses a hammer connected to analog input channel 0 of the DT9837B module and an accelerometer connected to analog input channel 1 of the DT9837B module to measure the impact of hitting a hammer against a table. The FFT Analyzer interface of QuickDAQ is used.

### Configure the Channels

Configure the channels as follows:

1. Ensure that a hammer and an accelerometer are connected to your data acquisition device.  
*In this example, connect the hammer to analog input channel 0 and connect the accelerometer to analog input channel 1 of a DT9837B module.*
2. Configure each analog input channel by clicking the **Configuration** menu, and clicking **Input Channel Configuration**.

Enable analog input channels 0 and 1 by clicking the checkbox under the **Enable** column:  
*In this example, analog input channels 0 and 1 are enabled.*

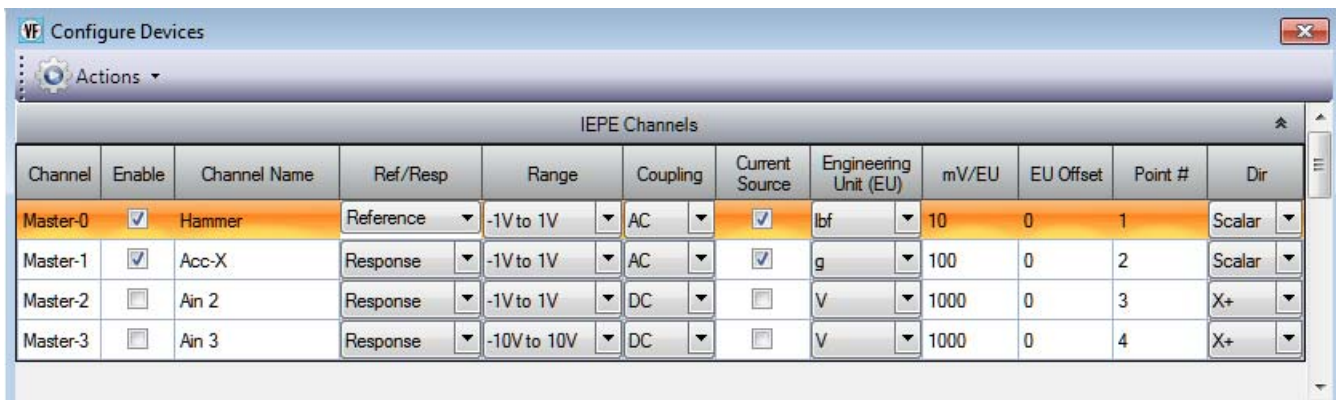

Channel	Enable	Channel Name	Ref/Resp	Range	Coupling	Current Source	Engineering Unit (EU)	mV/EU	EU Offset	Point #	Dir
Master-0	<input checked="" type="checkbox"/>	Hammer	Reference	-1V to 1V	AC	<input checked="" type="checkbox"/>	lbf	10	0	1	Scalar
Master-1	<input checked="" type="checkbox"/>	Acc-X	Response	-1V to 1V	AC	<input checked="" type="checkbox"/>	g	100	0	2	Scalar
Master-2	<input type="checkbox"/>	Ain 2	Response	-1V to 1V	DC	<input type="checkbox"/>	V	1000	0	3	X+
Master-3	<input type="checkbox"/>	Ain 3	Response	-10V to 10V	DC	<input type="checkbox"/>	V	1000	0	4	X+

3. Under the **Channel Name** column, enter the following names for the analog input channels:
  - For analog input channel 0, enter **Hammer**.
  - For analog input channel 1, enter **Acc-X**.
4. Under the **Ref/Resp** column, select **Reference** for analog input channel 0 (Hammer) and **Response** for analog input channel 1 (Acc-X).
5. Under the **Range** column, select the best effective input range ( $\pm 10$  V or  $\pm 1$  V) for each signal. For example, if your hammer and accelerometer measure 100 mV/g and your signal of interest is less than 100 g, choose the  $\pm 1$  V range; similarly, if your signal of interest is greater than 100 g, choose the  $\pm 10$  V range.  
*In this example,  $\pm 1$  V is used.*

6. Under the **Coupling** column, select the coupling type (AC or DC) for your sensor. For most IEPE accelerometers, you will want to choose **AC** coupling to remove any DC offset from your measurement. Choose **DC** coupling only if the signal source has no offset voltage or if the DC content of the acquired signal is important.

*In this example, AC is used.*

7. Under the **Current Source** column, select whether to enable or disable use of the 4 mA current source on the data acquisition device. Since most IEPE accelerometers require a current source of 4 mA and a compliance voltage of at least 18 V to drive their internal circuitry, in most cases, you will want to enable use of the current source for each analog input channel.

*In this example, the **Current Source** checkbox is checked (enabled) for both analog input channels.*

---

**Note:** If you enable the use of the internal 4 mA excitation current source, it is recommended that you choose AC coupling.

---

8. Under the **Engineering Units** column, select the engineering units for the hammer and the accelerometer.

*In this example, **lbf** is used for the hammer and **g** is used for the accelerometer.*

9. Using the calibration certificate that was supplied with your hammer and accelerometer, enter the calibrated sensitivity for the axis that is connected to the selected analog input channel in the **mV/EU** field. In this example, the following values are used:

- Analog input channel 0 (Hammer) = 10 mV/lbf
- Analog input channel 1 (Accelerometer) = 100 mV/g

10. If an offset is specified for the hammer and/or accelerometer, enter the value in the **EU Offset** field.

*In this example, no offset (0) is specified.*

11. If desired, enter a test point value for each channel. In this example, the following values are used:

- Analog input channel 0 (Hammer) = 1
- Analog input channel 1 (Acc-X) = 2

12. If desired, enter a sensor direction for each channel. In this example, the following values are used:

- Analog input channel 0 (Hammer) = Scalar
- Analog input channel 1 (Acc-X) = Scalar

13. Click **Close** to close the Channel Configuration dialog box.

## Configure the Recording Settings

For this example, configure the recording settings as follows:

1. Click the **Recording** tab of the Acquisition Config window.

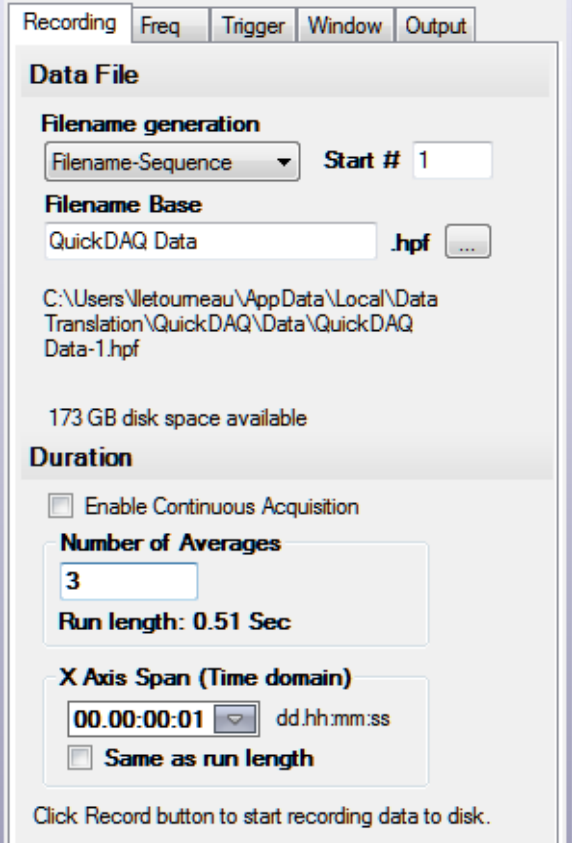

Recording Freq Trigger Window Output

**Data File**

**Filename generation**  
 Filename-Sequence Start # 1

**Filename Base**  
 QuickDAQ Data .hpf ...

C:\Users\Nletoumeau\AppData\Local\Data Translation\QuickDAQ\Data\QuickDAQ Data-1.hpf

173 GB disk space available

**Duration**

Enable Continuous Acquisition

**Number of Averages**  
 3

Run length: 0.51 Sec

**X Axis Span (Time domain)**  
 00:00:00:01 dd.hh:mm:ss

Same as run length

Click Record button to start recording data to disk.

2. For **Filename generation**, use the **Filename** option.
3. For **Filename**, use the default name for the data file.
4. Leave the **Enable Continuous Acquisition** checkbox unchecked.
5. For **Number of Averages**, enter 3 as the number of records to acquire, process, and average before acquisition stops.  
*The number of seconds for the entire run and the amount of available disk space are shown.*
6. Select the span you want to use for the time-domain data on the x-axis.

## Configure the Frequency Settings

For this example, configure the frequency settings as follows:

1. Click the **Freq** tab of the Acquisition Config window.

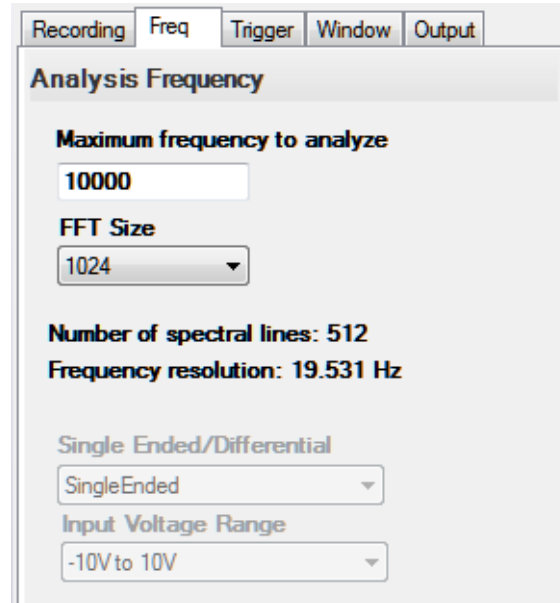

2. In the **Maximum frequency to analyze** text box, enter **10000** as the bandwidth or span, in Hz, of the input signals that you want to analyze  
*Internally, the sampling rate of the data acquisition device is set to twice the bandwidth, or 20000 Hz in this example.*
3. In the **FFT Size** text box, select **1024** from the drop-down combo box as the number of data points to use for the FFT calculation.  
*The number of spectral lines and the frequency resolution are displayed.*

## Configure the Trigger Settings

For this example, configure the trigger settings as follows:

1. Click the **Trigger** tab of the Acquisition Config window.

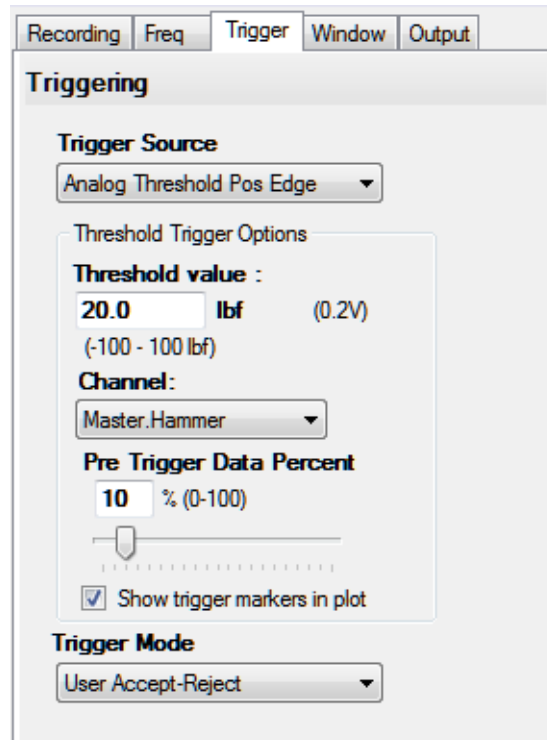



2. For the **Trigger Source**, select **Analog Threshold Pos Edge**.
3. For the **Threshold value**, enter **20.00 lbf**.  
*This ensures that the measurement starts when the hammer hits the table and at least 20 lbf is detected.*
4. Select Analog input channel 0 (**Hammer**) as the channel for the threshold trigger.
5. For the **Pre Trigger Data Percent**, enter 10%.
6. Select the **Show trigger markers in plot** checkbox.
7. For the **Trigger Mode**, select **User Accept-Reject**.

## Configure the Windowing Function

For this example, configure the windowing function as follows:

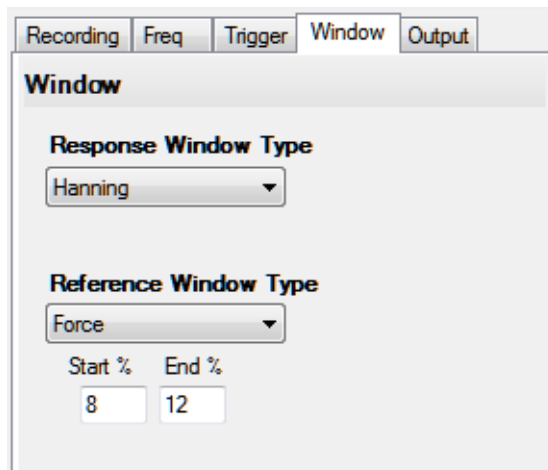
1. Click the **Window** tab of the Acquisition and Config window.



2. For the **Response Window Type**, select **Hanning**.  
*This is a global setting that is applied to the FFTs for all enabled analog input channels that are configured as response channels.*
3. For the **Reference Window Type**, select **Force**, and enter **8** for **Start%** and **12** for **End%**.
4. If desired, hide the Acquisition Config window by clicking the Auto-Hide pin (  ) in the top, right corner of the window.



## Add an FFT Channel to the Plot and Data Config Window

The following steps show how to use the FFT Analyzer interface of QuickDAQ to add an FFT channel to the Plot and Data Config window:

1. Click the **Add single channel FFT function** (  ) button to add an FFT channel to the Plot and Data Config window.
2. Select **Acc-X** as the FFT channel to add.  
*The Acc-X-FFT channel is added to the Plot and Data Config window.*

## Configure the FFT Channel

The following steps show how to use the FFT Analyzer interface of QuickDAQ to configure the parameters used for the FFT channel:

1. Select the **Acc-X-FFT** channel in the channel list.
2. Click the **Data** tab, and then click the **Function** tab.

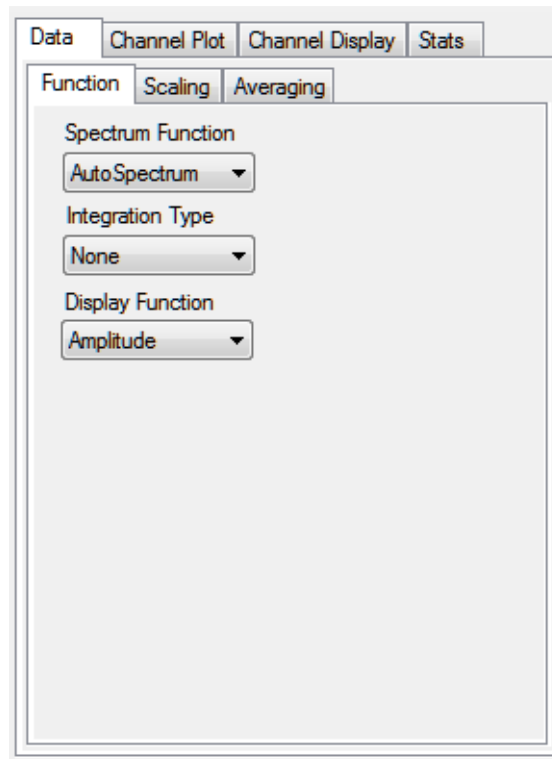

3. For this example, configure the settings of this tab as follows:
  - a. For **Spectrum Function**, select **AutoSpectrum**.
  - b. For **IntegrationType**, select **None**.
  - c. For **Display Function**, select **Amplitude**.

4. Click the **Scaling** tab, and configure the settings of this tab as follows:

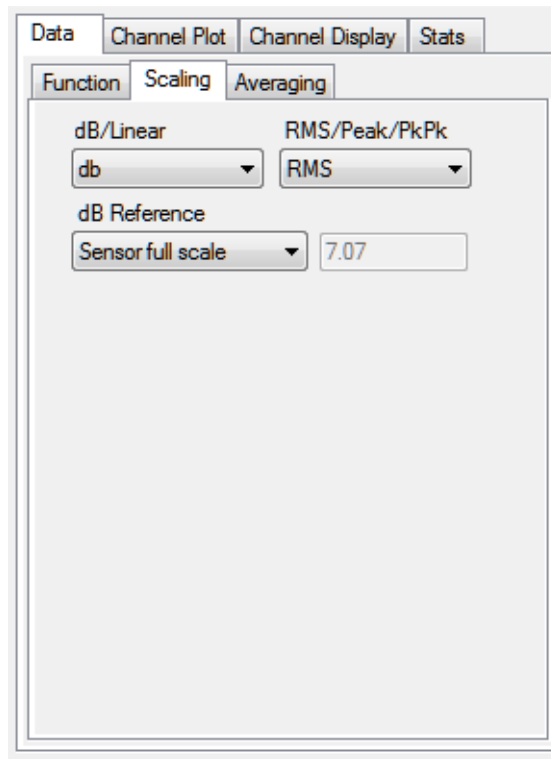

- a. For **dB/Linear**, select **dB**.
  - b. For **RMS/Peak/PkPk**, select **RMS**.
  - c. For **dB Reference**, select **Sensor full scale**.
5. Click the **Averaging** tab, and configure the settings of this tab as follows:

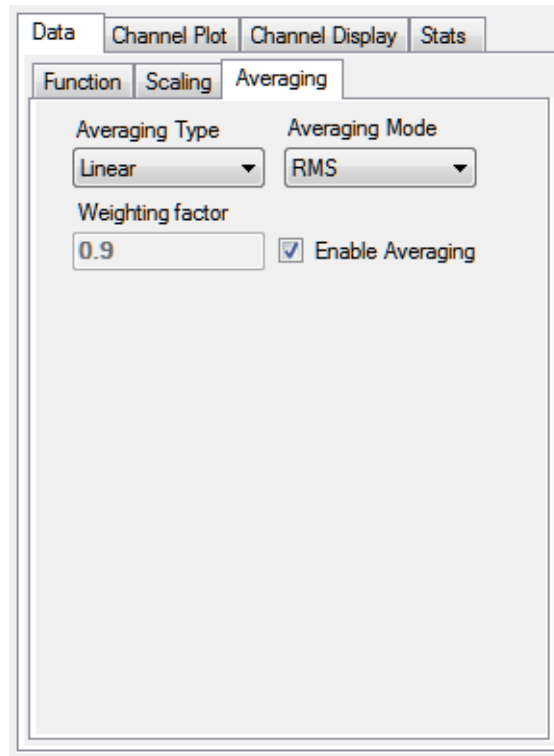

- a. Select the **Enable Averaging** checkbox.
- b. For **Averaging Type**, select **Linear**.
- c. For **Averaging Mode**, select **RMS**.

## Add an FRF Channel to the Plot and Data Config Window

The following steps show how to use the FFT Analyzer interface of QuickDAQ to add an FRF channel to the Plot and Data Config window to calculate the frequency response of analog input channel 0 (Hammer) and analog input channel 1 (Acc-X).

1. Click the **Add 2 channel FFT function** (  ) button, and select **FRF** to add an FRF channel to the Plot and Data Config window.
2. Select **Acc-X** as the response channel to add.  
*The Acc-X-FRF channel is added to the Plot and Data Config window.*

## Configure the FRF Channel

The following steps show how to use the FFT Analyzer interface of QuickDAQ to configure the parameters used to generate the FRF channels for the analog input channels:

1. Select the **Acc-X-FRF** channel in the channel list.
2. Click the **Data** tab, and then click the **Function** tab.

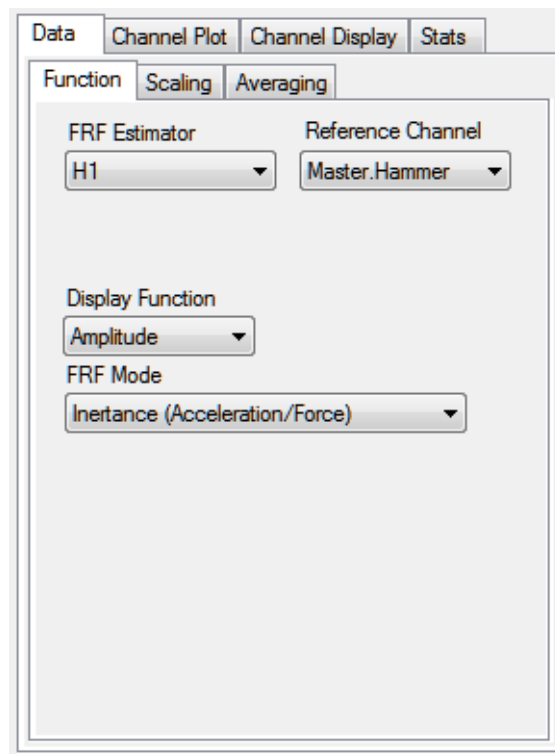

3. For the **Acc-X-FRF** channel, configure the settings of this tab as follows:
  - a. For **FRF Estimator**, select **H1** (reduces noise on the response channel).
  - b. For **Reference Channel**, select **Hammer** (analog input channel 0).
  - c. For **Display Function**, select **Amplitude**.
  - d. For **FRF Mode**, select **Inertance (Acceleration/Force)**.

- Click the **Scaling** tab, and select **Linear** for **dB/Linear**:

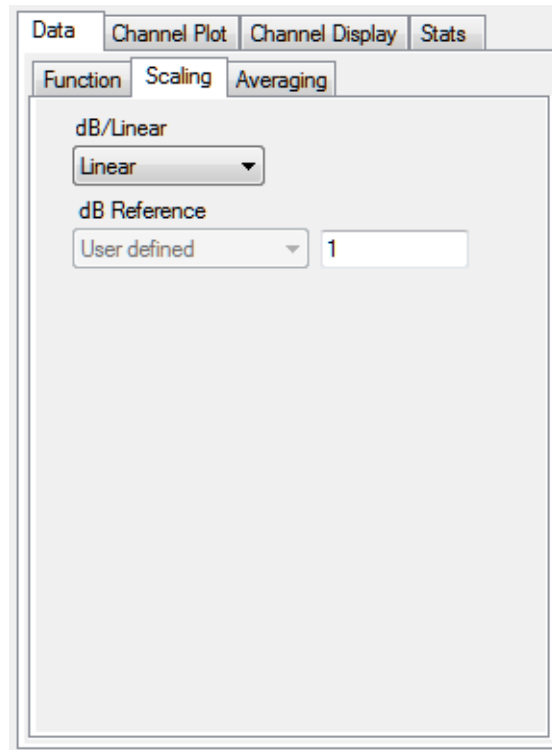

- Click the **Averaging** tab, select the **Enable Averaging** checkbox, and select **Linear** for **Averaging Type**:

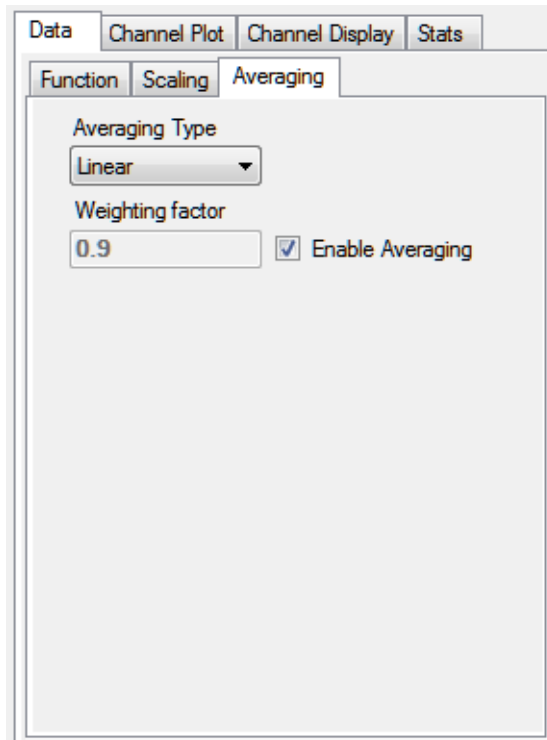

## Add a Coherence Channel to the Plot and Data Config Window

The following steps show how to use the FFT Analyzer interface of QuickDAQ to add a Coherence channel to the Plot and Data Config window:

1. Click the **Add 2 channel FFT function** (  ) button, and select **Coherence** to add a Coherence channel to the Plot and Data Config window.
2. Select **Acc-X** as the response channel to add.  
*The Acc-X-Coherence channel is added to the Plot and Data Config window.*

## Configure the Coherence Channel

The following steps show how to use the FFT Analyzer interface of QuickDAQ to configure the parameters used to generate the Coherence channel for the analog input channels:

1. Select the **Acc-X-Coherence** channel in the channel list.
2. Click the **Data** tab, and then click the **Function** tab.

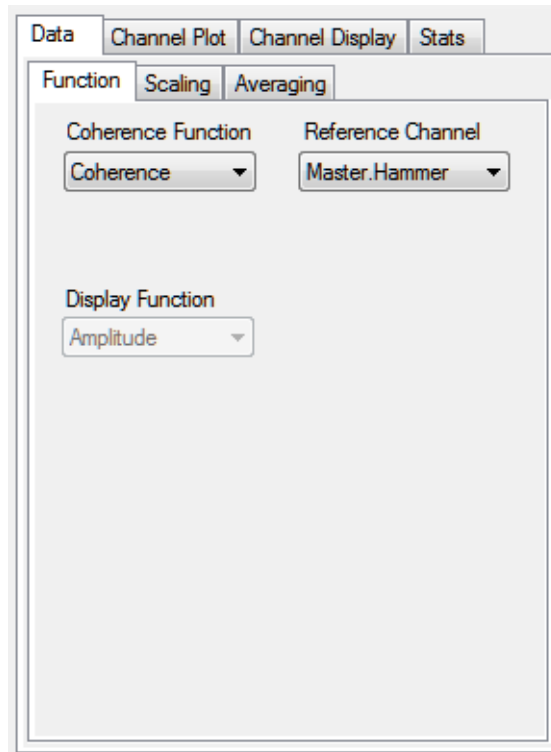

3. For this example, configure the settings of this tab as follows:
  - a. For **Coherence Function**, select **Coherence**.
  - b. For **Reference Channel**, select **Hammer** (analog input channel 0).

---

**Note:** **Linear** scaling is selected automatically for Coherence channels under the **Scaling** tab.

---



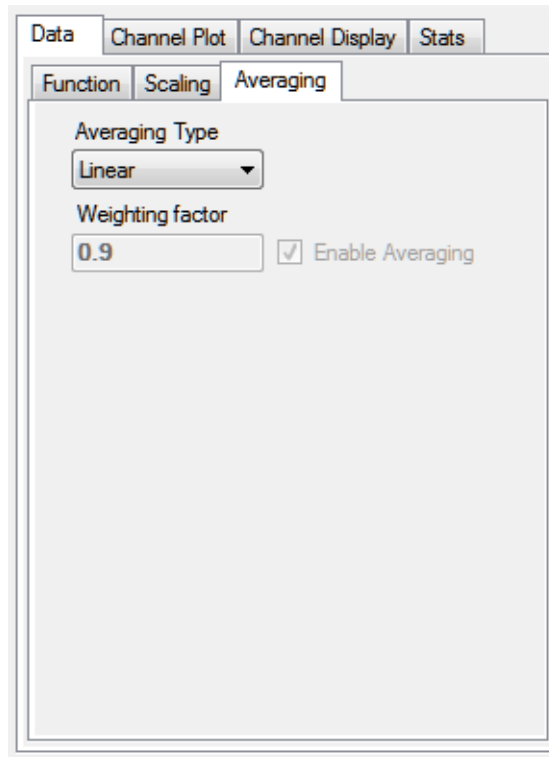





4. Click the **Averaging** tab, and select **Linear** for **Averaging Type**:



## Configure the Appearance of the Channel Plot Window

Perform the following steps to configure the appearance of the Channel Plot window:

1. Select the **Visible Plot** checkbox for the Hammer, Acc-X, Acc-X-Coherence, Acc-X-FRF, and Acc-X-FFT channels.

Channel Name	Visible Plot	Visible Display	Visible Statistics	Show Cursor	Plot Column	Signal Group	Color
Master.Hammer	<input checked="" type="checkbox"/>	<input checked="" type="checkbox"/>	<input checked="" type="checkbox"/>	<input type="checkbox"/>	1	None	
Master.Acc-X	<input checked="" type="checkbox"/>	<input checked="" type="checkbox"/>	<input checked="" type="checkbox"/>	<input type="checkbox"/>	1	None	
Master.Acc-X-FFT	<input checked="" type="checkbox"/>		<input type="checkbox"/>	<input type="checkbox"/>	1	None	
Master.Acc-X-FRF	<input checked="" type="checkbox"/>		<input type="checkbox"/>	<input type="checkbox"/>	2	None	
Master.Acc-X-Coherence	<input checked="" type="checkbox"/>		<input type="checkbox"/>	<input type="checkbox"/>	2	None	

- Under **Plot Column**, select plot column 1 for the Hammer, Acc-X, and Acc-X-FFT channels, and select plot column 2 for the Acc-X-Coherence and Acc-X-FRF channels.
- Assign a unique color to each trace for the visible channels.
- Click the **Channel Plot - Control** tab.

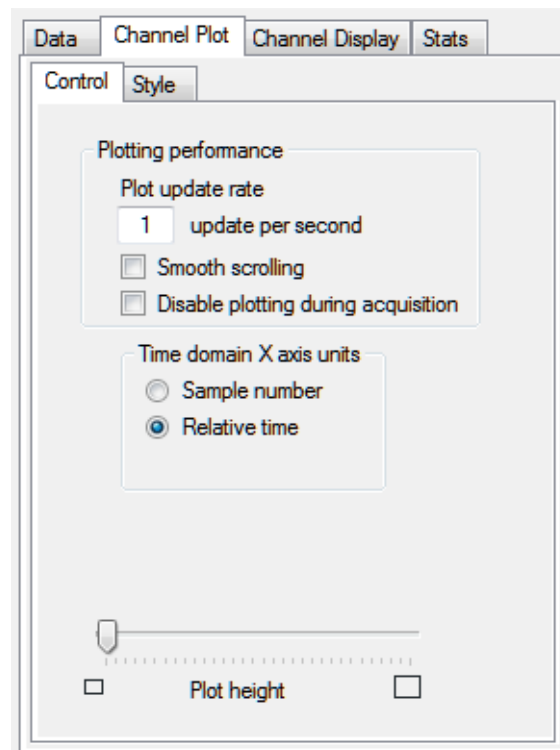

- Slide the **Plot height** bar to the left until you can see all 5 plots on the Channel Plot window at once.
- Click the **Channel Plot - Style** tab, and change the **Text** field to **Impact Data**.



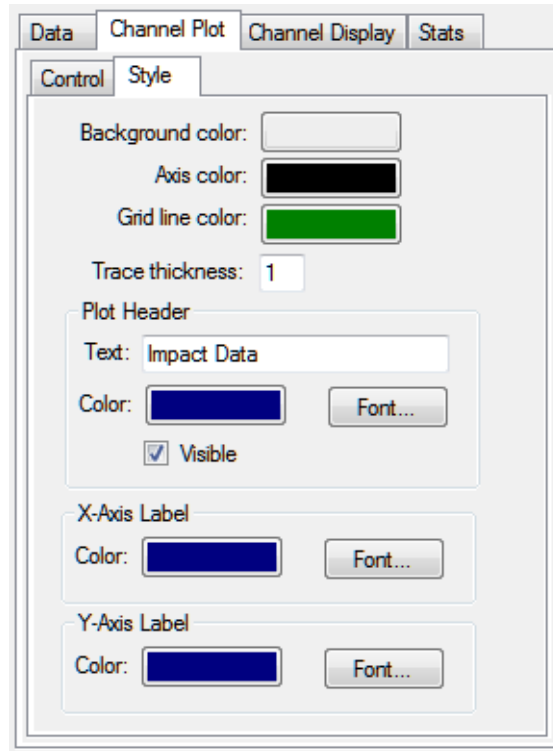

## Start the Impact Test

Once you have configured the channels and the parameters for the Channel Plot window, do the following to conduct the impact test:

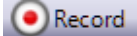
1. Click the **Record** toolbar button (  ) or press the **F5** key, and strike the hammer on the table.
2. Click **Accept** if the data appears correct or **Reject** if the data reflects a bad hammer strike.
3. Strike the hammer on the table and repeat steps 2 and 3 until three acquisitions have been accepted.

*Results similar to the following are displayed in the Channel Plot window.*



In this example, you can see by the trigger marker for the Hammer trace, which is in the same color as the Hammer trace color, that all the pre-trigger data (10% of the data) was acquired. The result of the hammer strike is measured by the Accelerometer (Acc-X). In addition, you can see the FFT, Coherence, and FRF of the accelerometer data.

## Add Another FRF Channel to the Plot and Data Config Window

The following steps show how to use the FFT Analyzer interface of QuickDAQ to add another FRF channel to the Plot and Data Config window for calculating the frequency response and phase information.

1. Click the **Add 2 channel FFT function** (  ) button, and select **FRF** to add an FRF channel to the Plot and Data Config window.
2. Select **Acc-X** as the response channel to add.  
*The Acc-X-FRF1 channel is added to the Plot and Data Config window.*
3. Select this channel and enter the following text to rename it: **Acc-X-FRF-Phase**.

## Configure the FRF Channel for Phase

The following steps show how to use the FFT Analyzer interface of QuickDAQ to configure the parameters used to generate the FRF channel:

1. Select the **Acc-X-FRF-Phase** channel in the channel list.
2. Click the **Data** tab, and then click the **Function** tab.

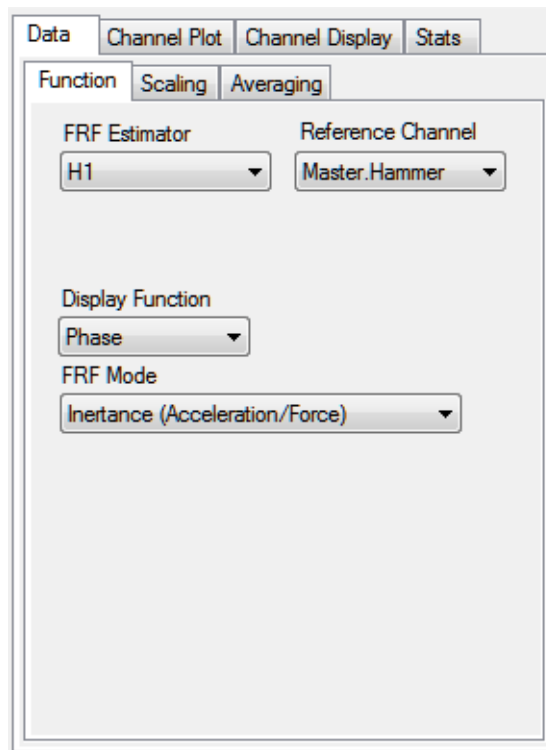

3. For the **Acc-X-FRF-Phase** channel, configure the settings of this tab as follows:
  - a. For **FRF Estimator**, select **H1** (reduces noise on the response channel).
  - b. For **Reference Channel**, select **Hammer** (analog input channel 0).
  - c. For **Display Function**, select **Phase**.
  - d. For **FRF Mode**, select **Inertance (Acceleration/Force)**.

---

**Note:** Linear scaling is automatically selected for the **Scaling** tab.

---

4. Click the **Averaging** tab, select the **Enable Averaging** checkbox, and select **Linear** for **Averaging Type**:

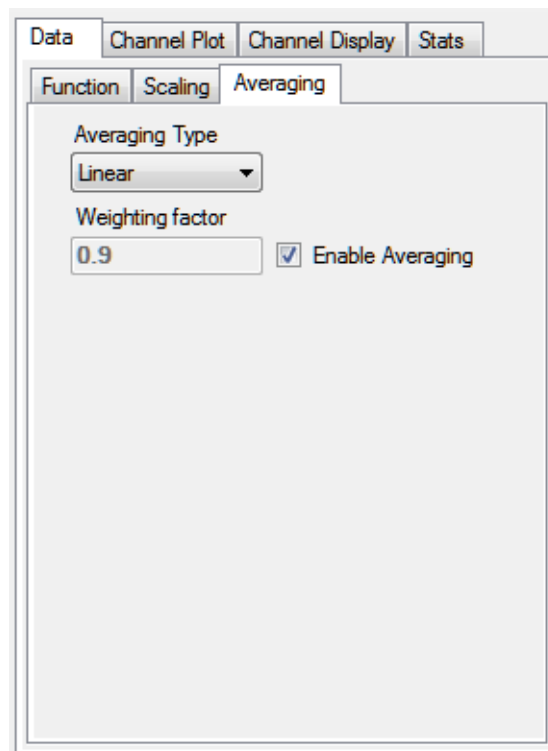

## Configure the Appearance of the Channel Plot Window

Perform the following steps to configure the appearance of the Channel Plot window:

1. Select the **Visible Plot** checkbox for the Hammer, Acc-X, Acc-X-FRF-Phase, Acc-X-FRF, and Acc-X-FFT channels.

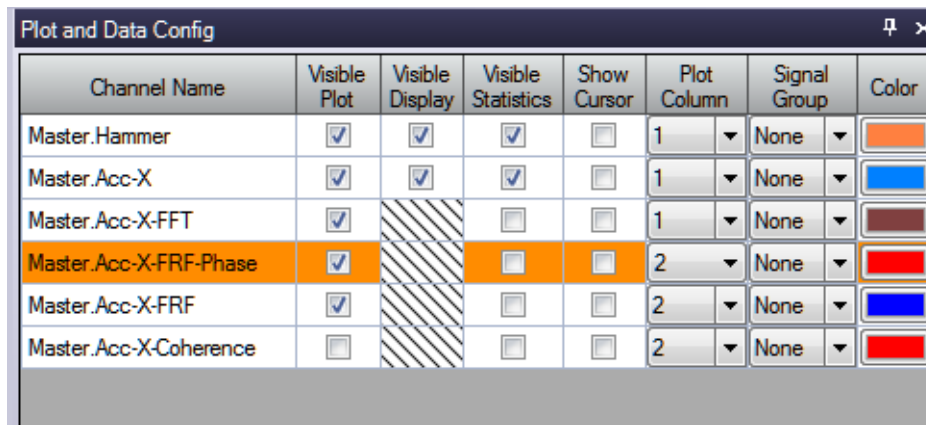

Channel Name	Visible Plot	Visible Display	Visible Statistics	Show Cursor	Plot Column	Signal Group	Color
Master.Hammer	<input checked="" type="checkbox"/>	<input checked="" type="checkbox"/>	<input checked="" type="checkbox"/>	<input type="checkbox"/>	1	None	
Master.Acc-X	<input checked="" type="checkbox"/>	<input checked="" type="checkbox"/>	<input checked="" type="checkbox"/>	<input type="checkbox"/>	1	None	
Master.Acc-X-FFT	<input checked="" type="checkbox"/>		<input type="checkbox"/>	<input type="checkbox"/>	1	None	
Master.Acc-X-FRF-Phase	<input checked="" type="checkbox"/>		<input type="checkbox"/>	<input type="checkbox"/>	2	None	
Master.Acc-X-FRF	<input checked="" type="checkbox"/>		<input type="checkbox"/>	<input type="checkbox"/>	2	None	
Master.Acc-X-Coherence	<input type="checkbox"/>		<input type="checkbox"/>	<input type="checkbox"/>	2	None	

2. Under **Plot Column**, select plot column 1 for the Hammer, Acc-X, and Acc-X-FFT channels, and plot column 2 for the Acc-X-FRF-Phase and Acc-X-FRF channels.
3. Assign a unique color to each trace for the visible channels, if desired.

## Restart the Impact Test

Once you have added and configured the Acc-X-Phase channel and configured the parameters for the Channel Plot window, do the following to restart the impact test:

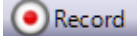
1. Click the **Record** toolbar button (  ) or press the **F5** key, and strike the hammer on the table.
2. Click **Accept** if the data appears correct or **Reject** if the data reflects a bad hammer strike.
3. Strike the hammer on the table and repeat steps 2 and 3 until three acquisitions have been accepted.

*Results similar to the following are displayed in the Channel Plot window.*



In this example, you can see by the trigger marker for the Hammer trace, which is in the same color as the Hammer trace color, that all the pre-trigger data (10% of the data) was acquired. The result of the hammer strike is measured by the Accelerometer (Acc-X). In addition, you can see the FFT, FRF-Phase, and FRF (Amplitude) of the accelerometer data.

## Strain Gage Example





If you are using the FFT Analysis or Advanced FFT Analysis option of QuickDAQ, you can use the following steps to perform a strain gage measurement.

This example uses a full-bridge strain gage (full-bridge bending configuration) connected to a DT9838 module to measure strain. In this example, TEDS is not supported for the strain gage. The FFT Analyzer interface is used.

### Configure the Channels

Configure the channels as follows:

1. Ensure that the strain gage is connected to your data acquisition device.  
*In this example, the strain gage is connected to analog input channel 0 of the DT9838. Refer to the wiring diagram for a full-bridge bending configuration in the DT9838 User's Manual for more information.*
2. Configure each analog input channel by clicking the **Input Channel Configuration** toolbar button (  ) or by clicking the **Configuration** menu and clicking **Input Channel Configuration**.
3. Enable analog input channel 0 by clicking the **Enable** checkbox for analog input channel 0.

Channel	Enable	Channel Name	Ref/Resp	Enable Shunt Resistor	Configure and Calibrate	Point #
DT9838(00)-0	<input checked="" type="checkbox"/>	Full Bridge Bending	Response	<input type="checkbox"/>	 Configure and Calibrate	1
DT9838(00)-1	<input type="checkbox"/>	Ain 1	Response	<input type="checkbox"/>	 Configure and Calibrate	2
DT9838(00)-2	<input type="checkbox"/>	Ain 2	Response	<input type="checkbox"/>	 Configure and Calibrate	3
DT9838(00)-3	<input type="checkbox"/>	Ain 3	Response	<input type="checkbox"/>	 Configure and Calibrate	4

4. In the **Channel Name** column, enter **Full Bridge Bending** for the name of analog input channel 0.
5. In the **Ref/Resp** column, leave **Response** selected for this example.
6. In the **Enable Shunt Resistor** column, leave the checkbox unchecked; this disables the shunt resistor.
7. Click the **Configure and Calibrate** button.  
*The following wizard appears:*

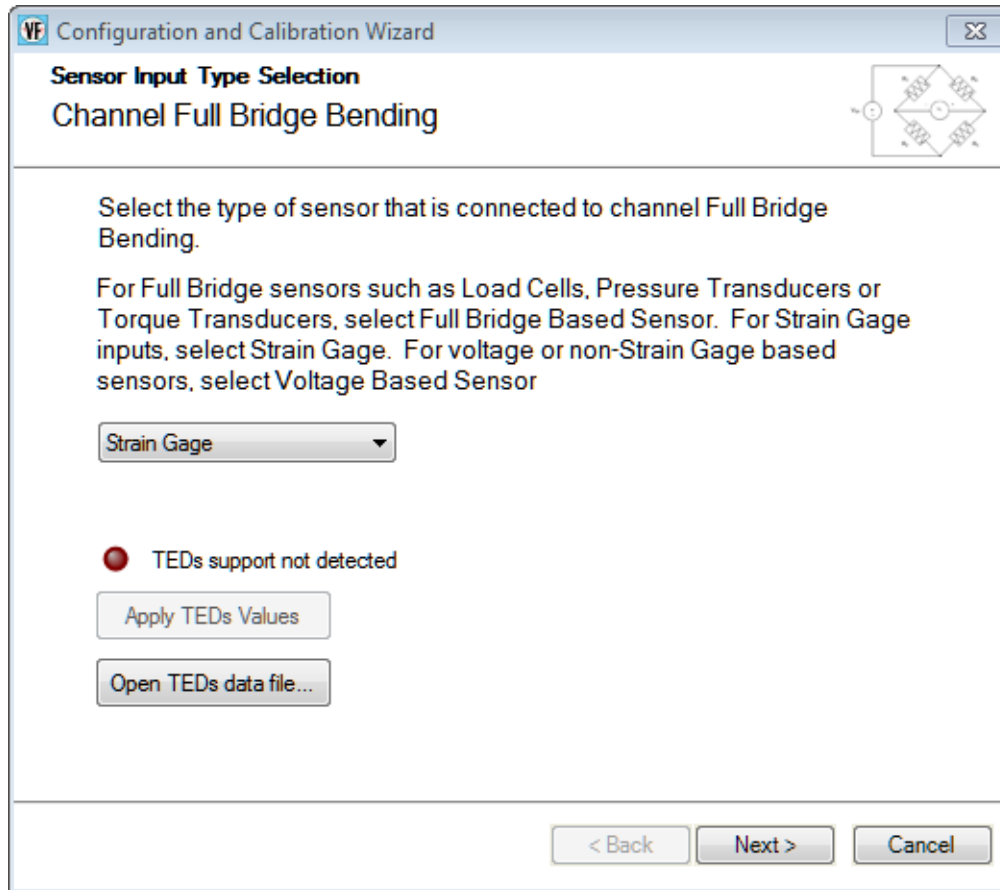

8. Select **Strain Gage**, and click **Next**. (Note that TEDS is not supported for this sensor; therefore, you do not need to click the **Open TEDS data file...** button.)  
*A screen similar to the following appears:*



**VF Configuration and Calibration Wizard**

**Strain Gage Configuration**  
Channel Full Bridge Bending

Bridge Type: **Full Bridge Bending**    Excitation Voltage: **5**    Note: This value will be set for all channels.

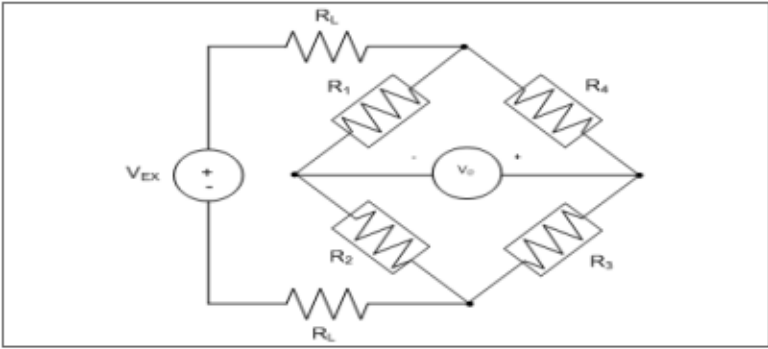

Nominal Gage: **350** Ohms    Using Sense Lines: **No**    Min Range: **-1000**  $\mu$ Strain    Unit:  **$\mu$ Strain**

Gage Factor: **2**    Lead Wire Resistance: **0.1** Ohms    Max Range: **1000**  $\mu$ Strain    Poisson Ratio: **0.32** ?

< Back    Next >    Cancel

9. For the **Bridge Type** field, select the bridge configuration of your strain gage.  
*In this example, the **Full Bridge Bending** bridge configuration is used.*
10. For the **Excitation Voltage** field, enter the excitation voltage value for your strain gage.  
*In this example, **5 V** is used as the excitation voltage value.*
11. For the **Nominal Gage** field, enter the nominal gage resistance, in ohms, for your strain gage as determined by the manufacturer.  
*In this example, **350** is used as the nominal gage resistance.*
12. For the **Gage Factor** field, enter the gage factor for your strain gage as determined by the manufacturer.  
*In this example, **2** is used as the gage factor.*
13. For the **Using Sense Lines** field, select **Yes** if you are using remote sense lines in your wiring, or **No** if you are not using remote sensing in your wiring.  
*In this example, remote sensing is not used.*
14. For the **Lead Wire Resistance** field, enter the lead wire resistance, in ohms, for your strain gage.  
*In this example, **0.1** is used as the lead wire resistance.*
15. For the **Min Range** field, enter the minimum value of the range for your strain gage.  
*In this example, **-1000** is used as the minimum strain value.*

16. For the **Max Range** field, enter the maximum value of the range for your strain gage.  
*In this example, 1000 is used as the maximum strain value.*
17. For the **Units** field, select the engineering units for the strain gage.  
*In this example,  $\mu\text{Strain}$  is used.*
18. In the **Poisson Ratio** column, enter the Poisson ratio for your strain gage, if applicable.  
*In this example, the Poisson ratio is not used.*
19. Click **Next**.  
*A screen similar to the following appears:*

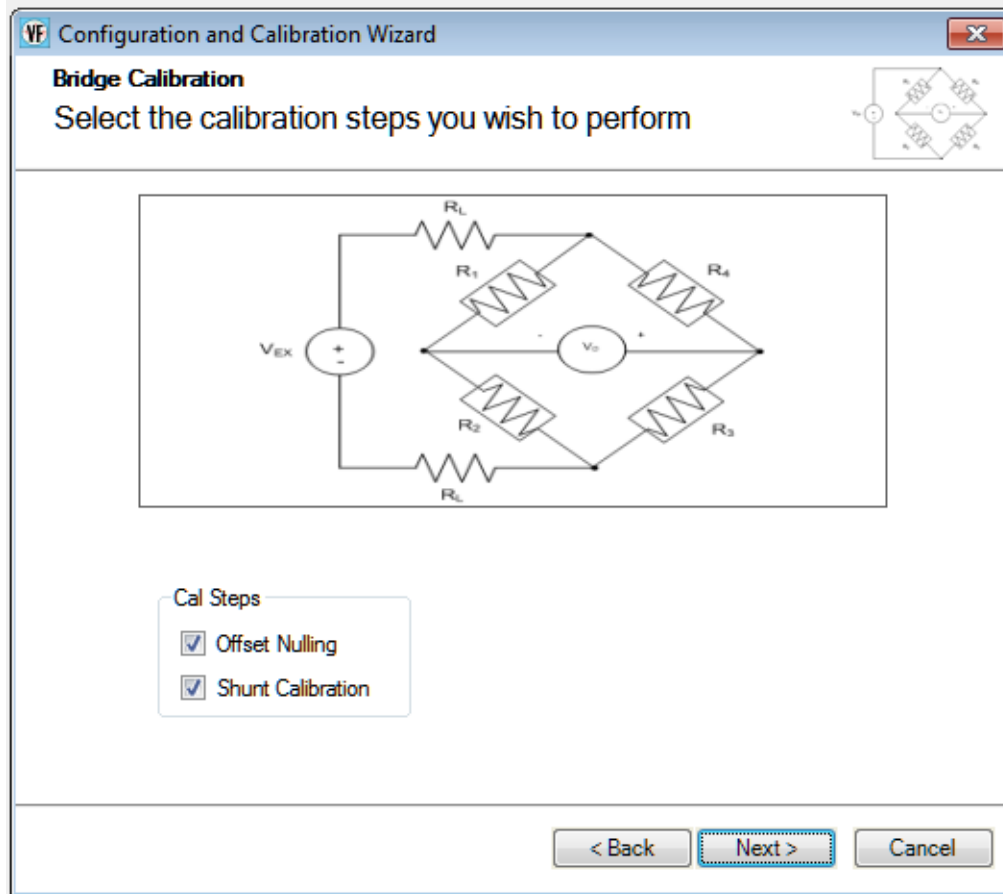

20. Select the calibration steps to perform.  
*In this example, **Offset Nulling** and **Shunt Calibration** are selected.*
21. Click **Next**.  
*A screen similar to the following appears:*

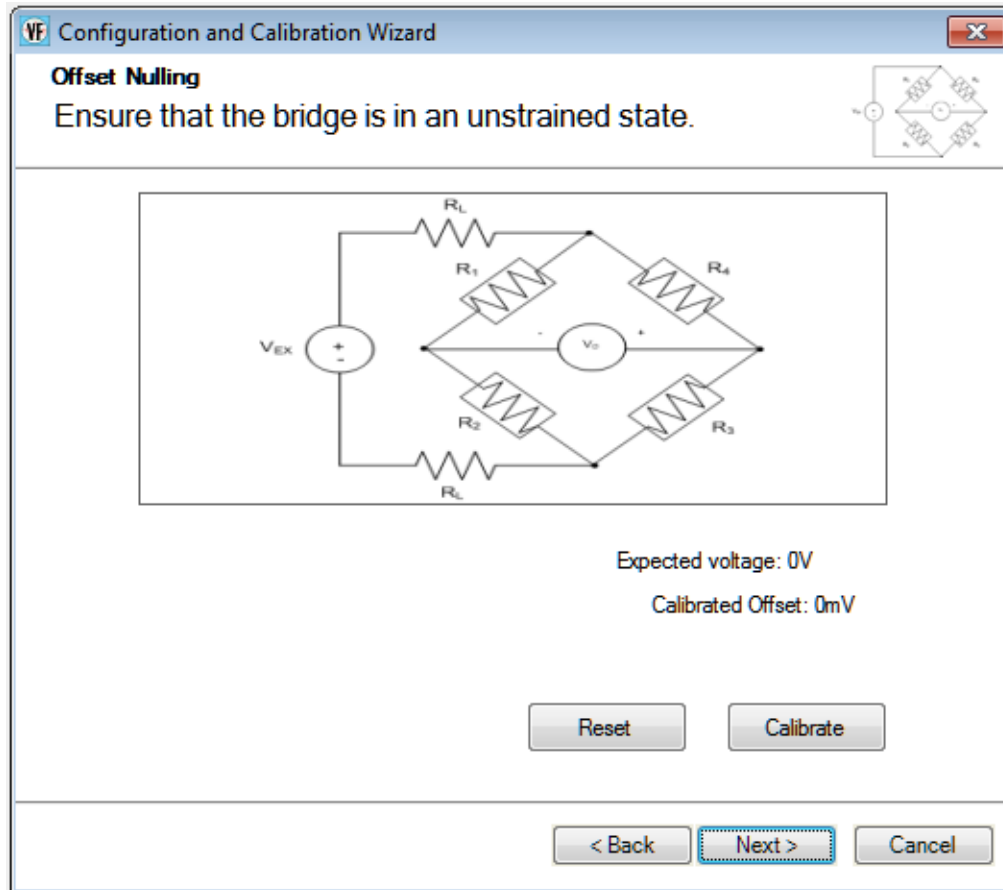

22. Ensure that the bridge is in the unstrained state, and click the **Calibrate** button to perform offset nulling procedure.  
*The expected voltage is shown along with the calibrated offset voltage.*

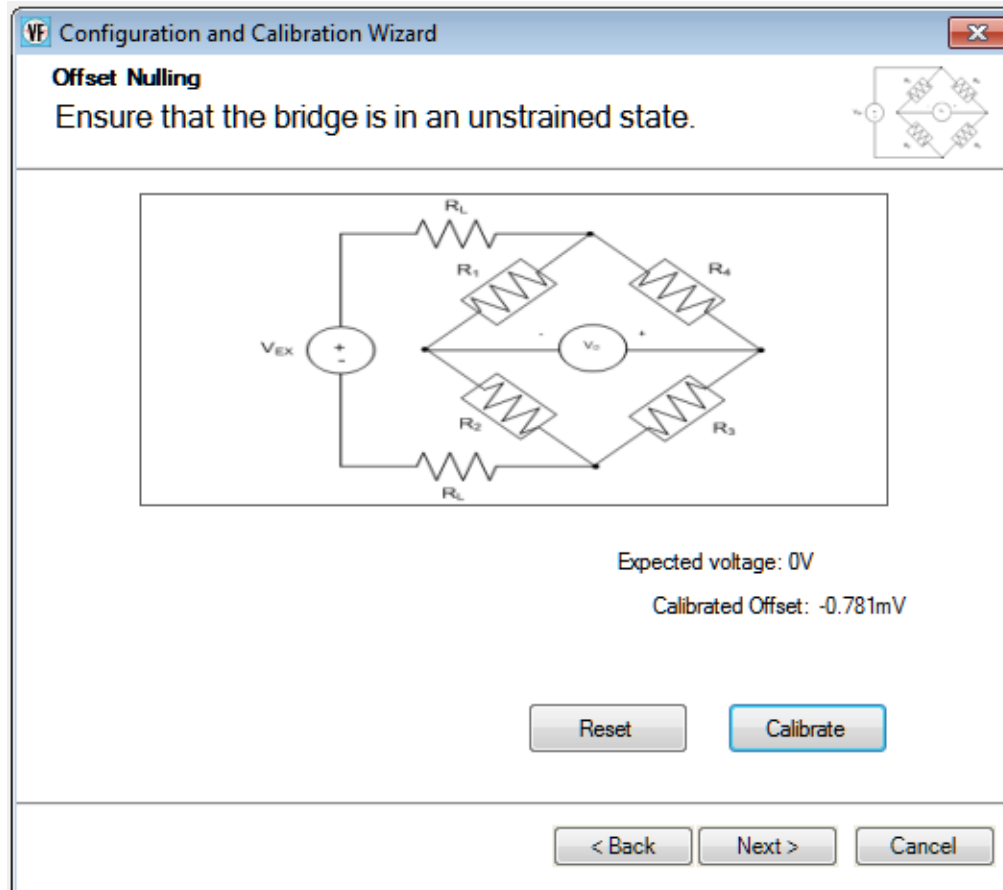

23. Click Next.

*A screen similar to the following appears:*

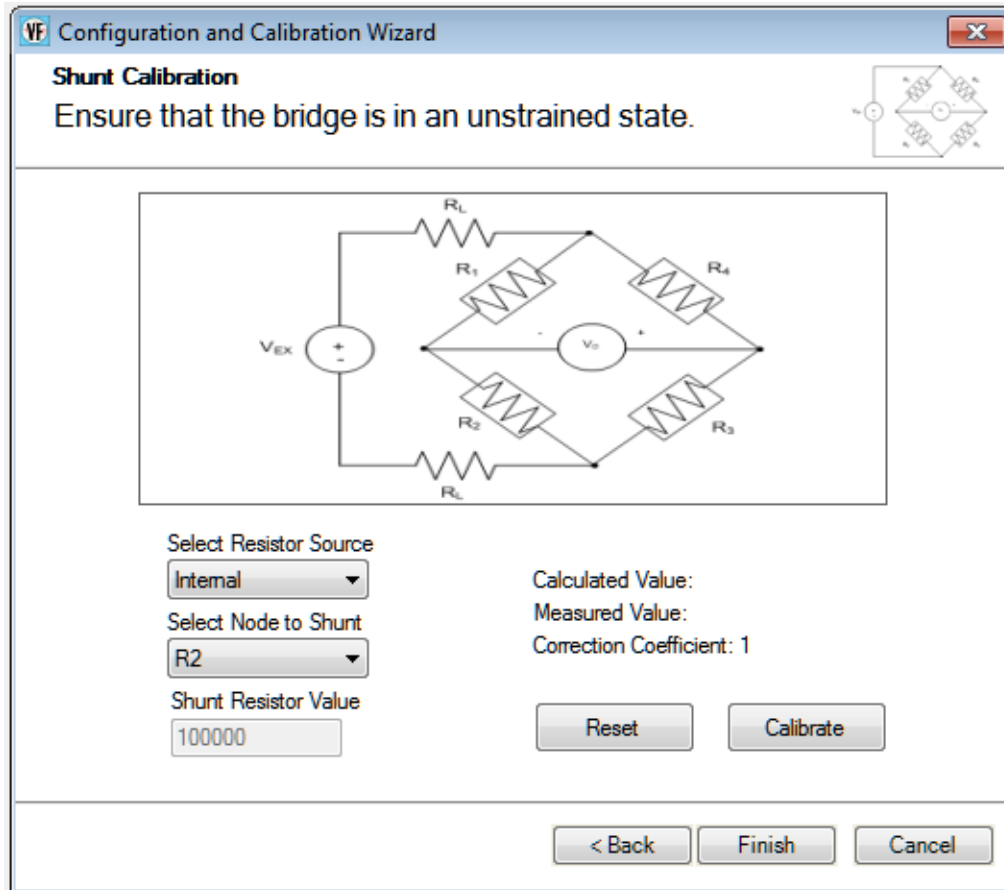

24. For the **Select Resistor Source** field, select **Internal** if you are using the internal shunt resistor provided on the DT9838 module to perform shunt calibration, or **External** if you are using your own external resistor to perform shunt calibration.  
*In this example, **Internal** is used.*
25. For the **Select Node to Shunt** field, select the resistive node or element to which to apply the shunt resistor.  
*In this example, **R2** is used.*
26. Click **Calibrate** to perform the shunt calibration procedure.  
*The calculated value is displayed along with the measured value and correction coefficient.*

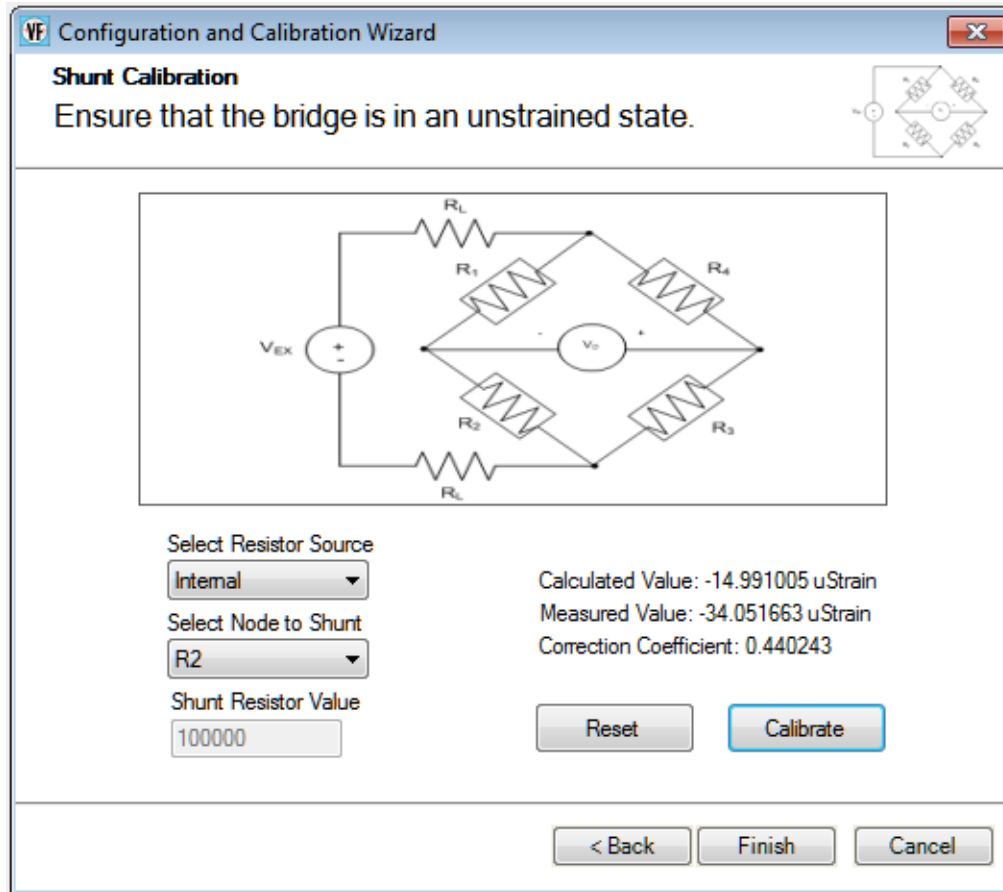

27. Click **Finish**.

28. If desired, enter a test point number under the **Point #** column.

*In this example, 1 is used.*

29. Click **Close** to close the **Configure Devices** dialog box.

## Configure the Recording Settings

For this example, configure the recording settings as follows:

1. Click the **Recording** tab of the Acquisition Config window.

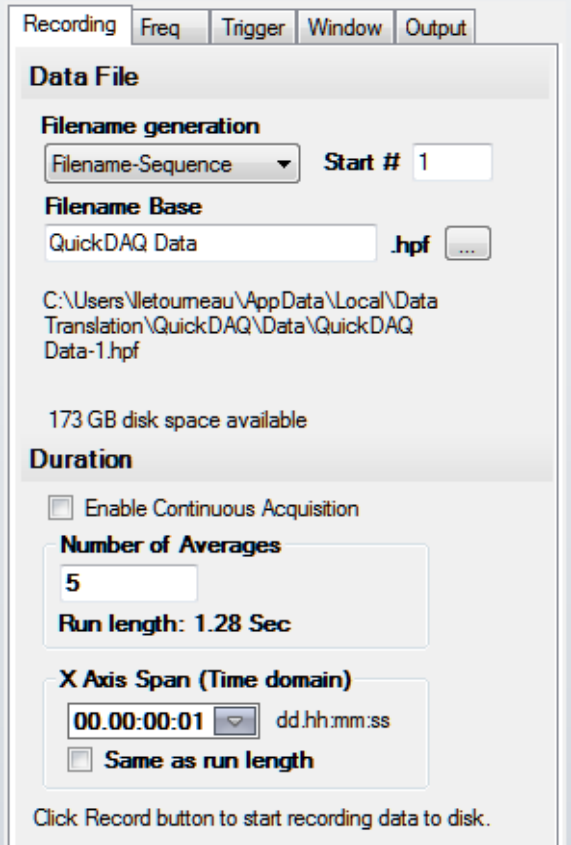

Recording Freq Trigger Window Output

**Data File**

**Filename generation**  
 Filename-Sequence Start # 1

**Filename Base**  
 QuickDAQ Data .hpf ...

C:\Users\Nletoumeau\AppData\Local\Data Translation\QuickDAQ\Data\QuickDAQ Data-1.hpf

173 GB disk space available

**Duration**

Enable Continuous Acquisition

**Number of Averages**  
 5

Run length: 1.28 Sec

**X Axis Span (Time domain)**  
 00:00:00:01 dd.hh:mm:ss

Same as run length

Click Record button to start recording data to disk.

2. For **Filename generation**, use the **Filename** option.
3. For **Filename**, use the default name for the data file.
4. Leave the **Enable Continuous Acquisition** checkbox unchecked.
5. For **Number of Averages**, enter 5 as the number of records to acquired, process, and average before acquisition stops.  
*The number of seconds for the total run and the amount of available disk space are shown.*
6. Select the span you want to use for the time-domain data on the x-axis.

## Configure the Frequency Settings

For this example, configure the frequency settings as follows:

1. Click the **Freq** tab of the Acquisition Config window.

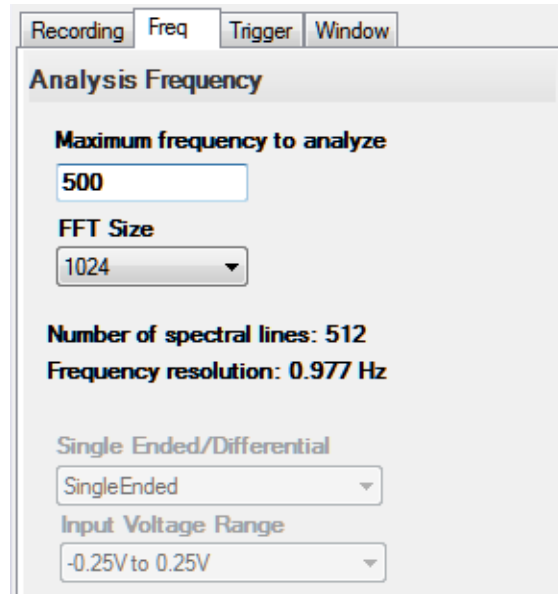

2. In the **Maximum frequency to analyze** text box, enter **500** as the bandwidth or span, in Hz, of the input signals that you want to analyze  
*Internally, the sampling rate of the data acquisition device is set to twice the bandwidth, or 1000 Hz in this example.*
3. In the **FFT Size** text box, select **1024** from the drop-down combo box as the number of data points to use for the FFT calculation.  
*The number of spectral lines and the frequency resolution are displayed.*



## Configure the Trigger Settings

For this example, configure the trigger settings as follows:

1. Click the **Trigger** tab of the Acquisition Config window.

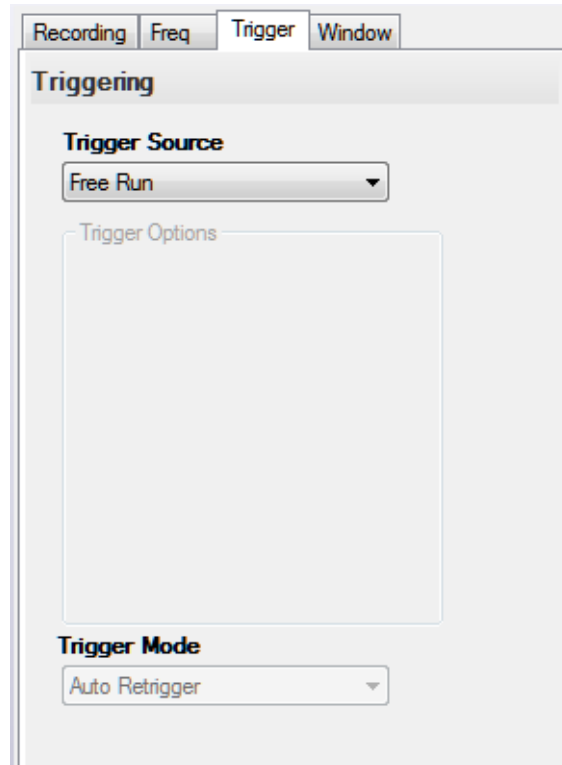

2. For the **Trigger Source**, select **Free Run** to ensure that the measurement starts as soon as the **Record** button is clicked.

## Start the Strain Measurement

Once you have configured the channels, start acquisition and log data to disk by clicking the **Record** toolbar button (  **Record** ).

*Results similar to the following are displayed in the Channel Plot window.*

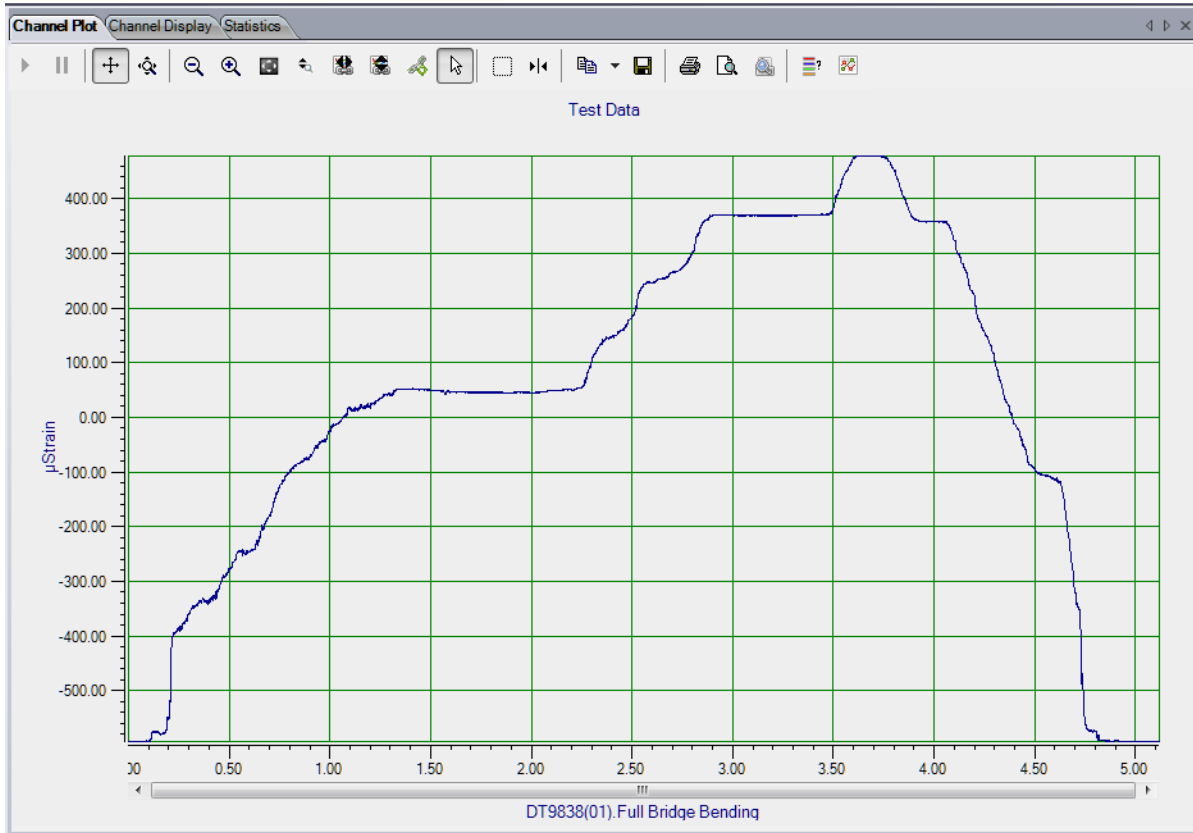

## Export the Data to Excel

You can export the acquired data to Microsoft Excel for further analysis by performing the following steps:

1. Click the **Open Current Data in Excel** toolbar button  .
2. Click **Time Series Data..**

*Microsoft Excel then opens and displays the data that was acquired, as shown in the following example.*

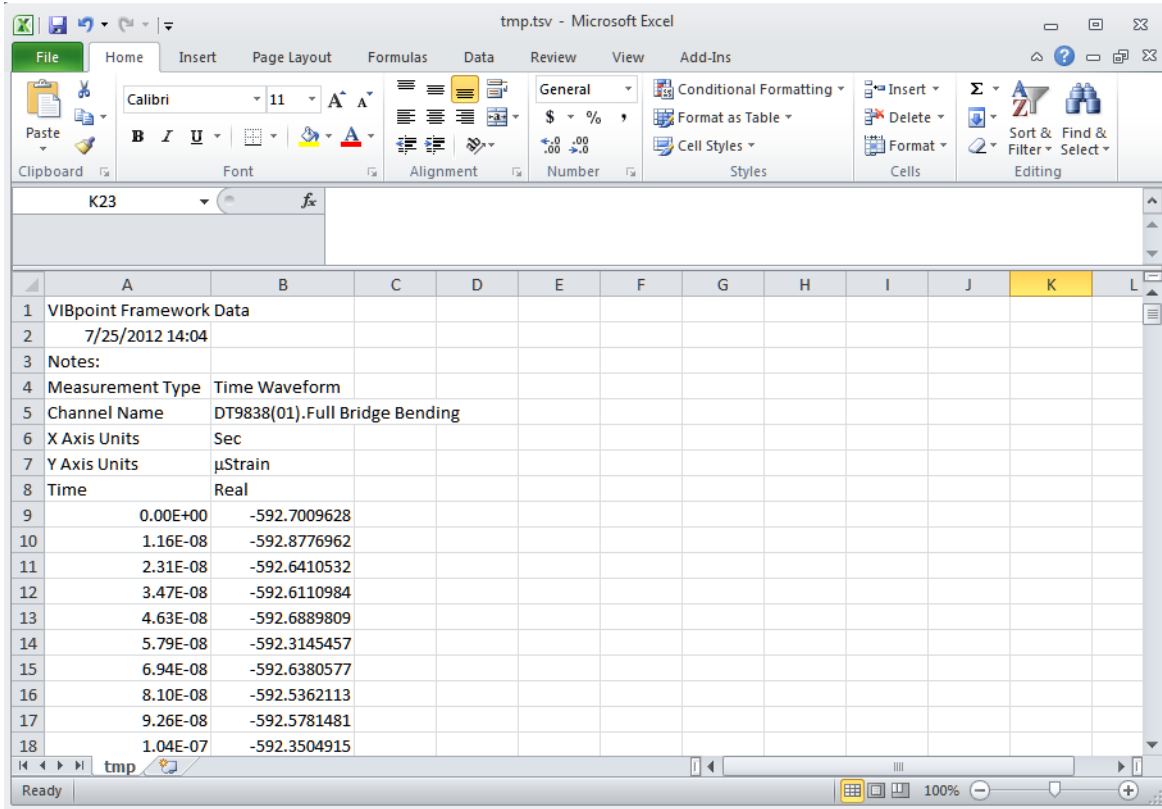

The screenshot shows a Microsoft Excel window titled "tmp.tsv - Microsoft Excel". The ribbon includes File, Home, Insert, Page Layout, Formulas, Data, Review, View, and Add-Ins. The spreadsheet content is as follows:

	A	B	C	D	E	F	G	H	I	J	K	L
1	VIBpoint Framework Data											
2	7/25/2012 14:04											
3	Notes:											
4	Measurement Type	Time Waveform										
5	Channel Name	DT9838(01).Full Bridge Bending										
6	X Axis Units	Sec										
7	Y Axis Units	μStrain										
8	Time	Real										
9	0.00E+00	-592.7009628										
10	1.16E-08	-592.8776962										
11	2.31E-08	-592.6410532										
12	3.47E-08	-592.6110984										
13	4.63E-08	-592.6889809										
14	5.79E-08	-592.3145457										
15	6.94E-08	-592.6380577										
16	8.10E-08	-592.5362113										
17	9.26E-08	-592.5781481										
18	1.04E-07	-592.3504915										

## Bridge-Based Sensor Example

If you are using the FFT Analysis or Advanced FFT Analysis option of QuickDAQ, you can use the following steps to configure a bridge-based sensor to measure compression.

This example uses a load cell (a hand gripper) connected to a DT9838 module to measure compression, in pounds. In this example, the load cell supports hardware TEDS. The FFT Analyzer interface is used.

### Configure the Channels

Configure the channels as follows:

1. Ensure that the load cell is connected to your data acquisition device.  
*In this example, the hand gripper load cell is connected to analog input channel 0 of the DT9838.*
2. Configure each analog input channel by clicking the **Input Channel Configuration** toolbar button (  ) or by clicking the **Configuration** menu and clicking **Input Channel Configuration**.
3. Enable analog input channel 0 by clicking the **Enable** checkbox for analog input channel 0.

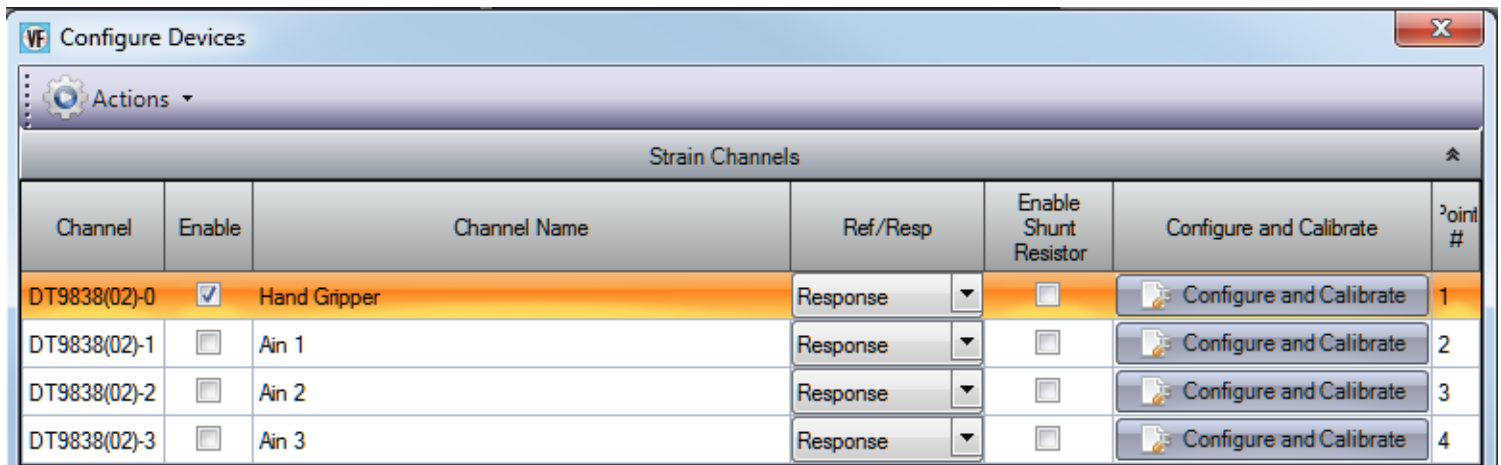

4. In the **Channel Name** column, enter **Hand Gripper** for the name of analog input channel 0.
5. In the **Ref/Resp** column, leave **Response** selected for this example.
6. In the **Enable Shunt Resistor** column, leave the checkbox unchecked; this disables the shunt resistor.
7. Click the **Configure and Calibrate** button.  
*The following wizard appears:*

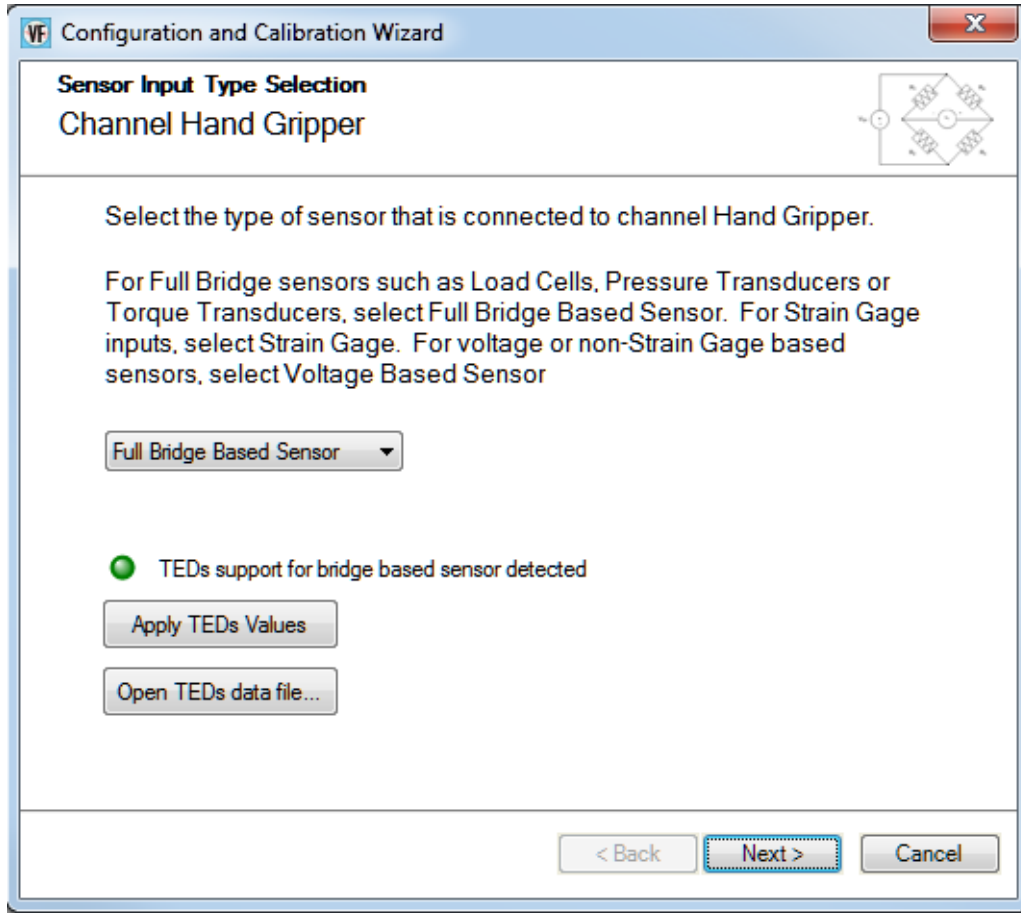

**8. Select Full Bridge Based Sensor.**

*Since TEDS is supported by the hardware, the LED turns green and the message "TEDs support for bridge based sensor detected" appears.*

**9. Click **Apply TEDs Values** to apply the TEDS values from the hardware to the channel configuration.**

**10. Click **Next**.**

*A screen similar to the following appears:*

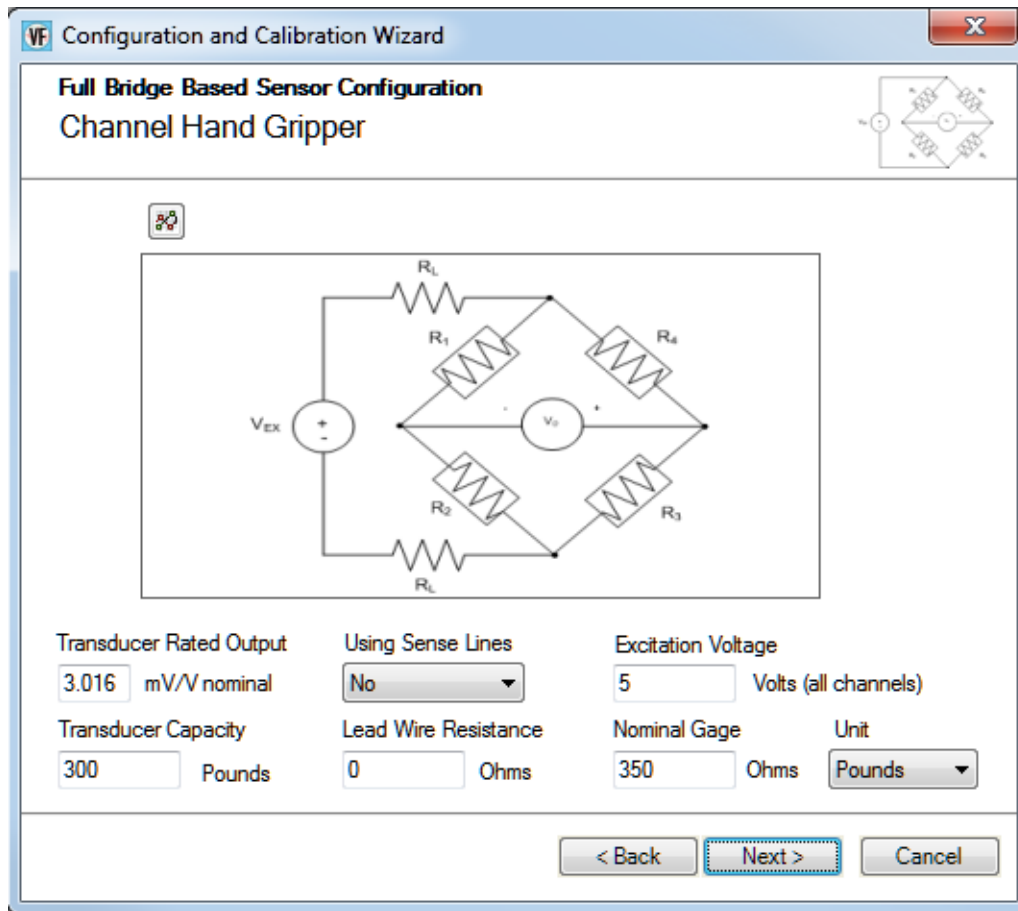

The TEDS values are read from the hardware, applied to the channel configuration, and displayed in the fields on this screen.

11. If desired, you can modify any of the parameters for the load cell.
12. Click **Next**.

*A screen similar to the following appears:*

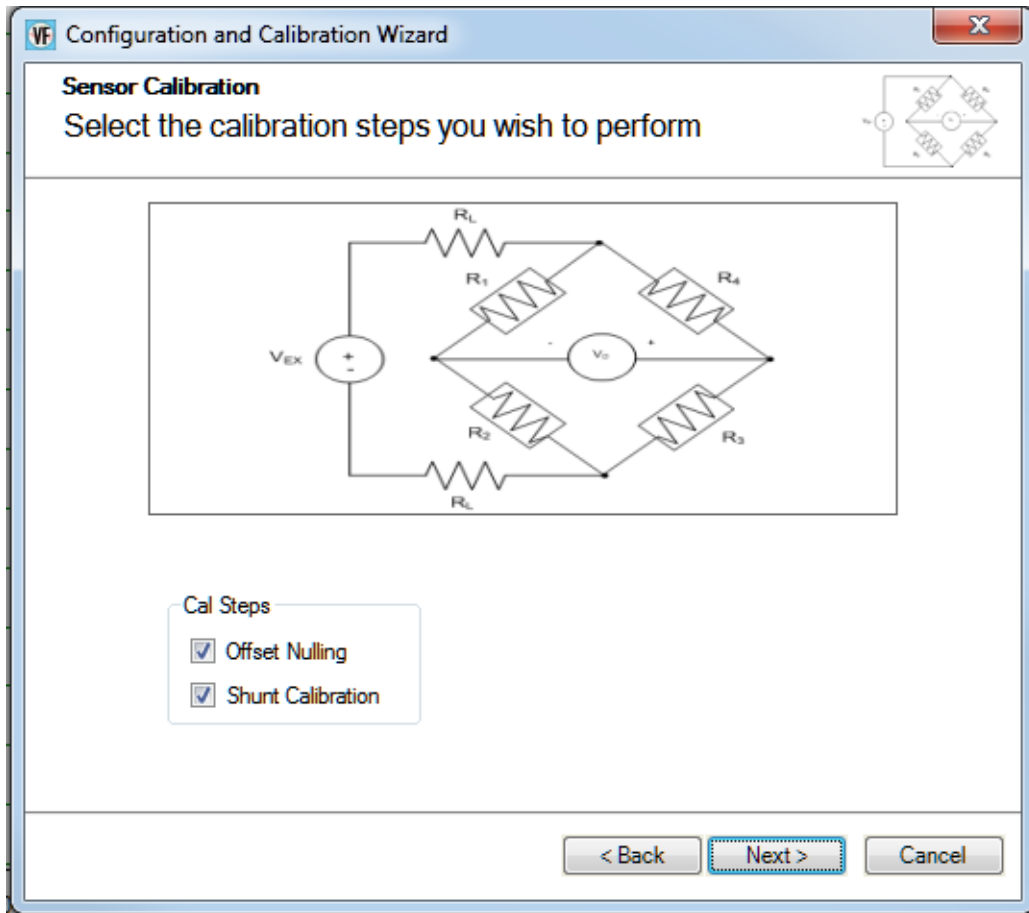

13. Select the calibration steps to perform.

*In this example, **Offset Nulling** and **Shunt Calibration** are selected.*

14. Click **Next**.

*A screen similar to the following appears:*

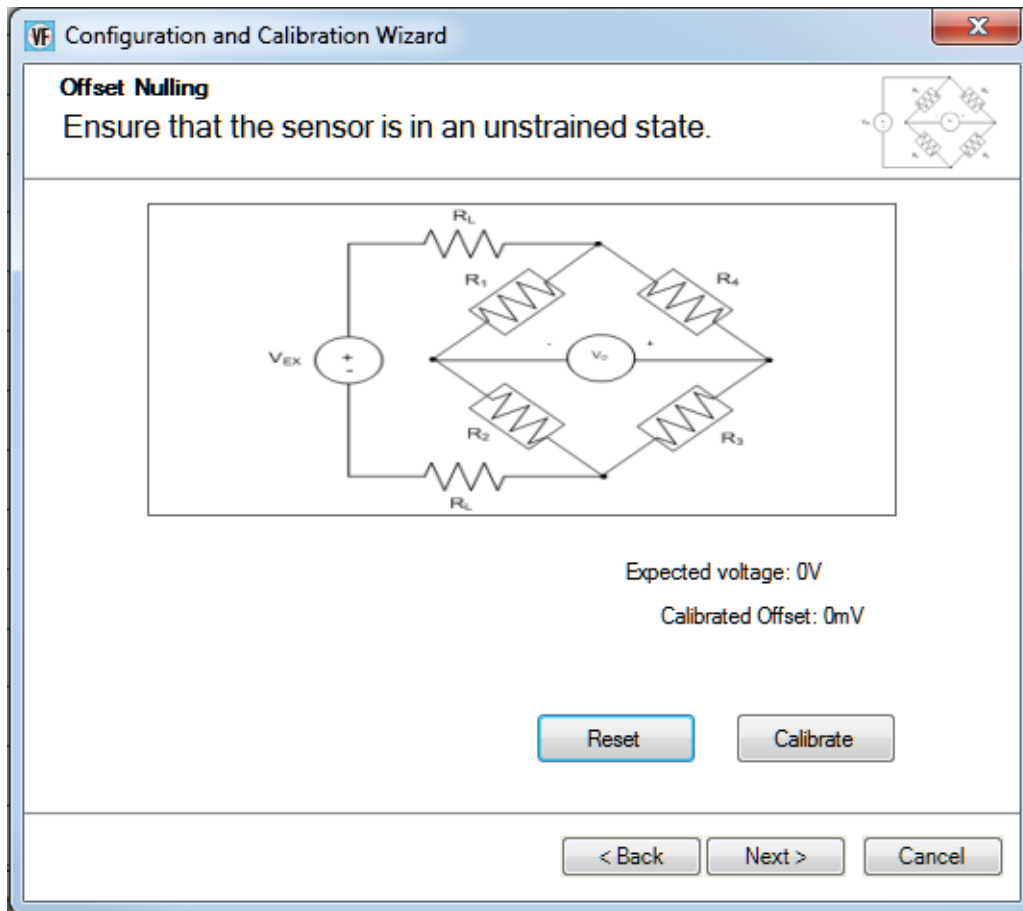

15. Ensure that the bridge is in the unstrained state, and then click the **Calibrate** button to perform offset nulling procedure.  
*The expected voltage is shown along with the calibrated offset voltage.*



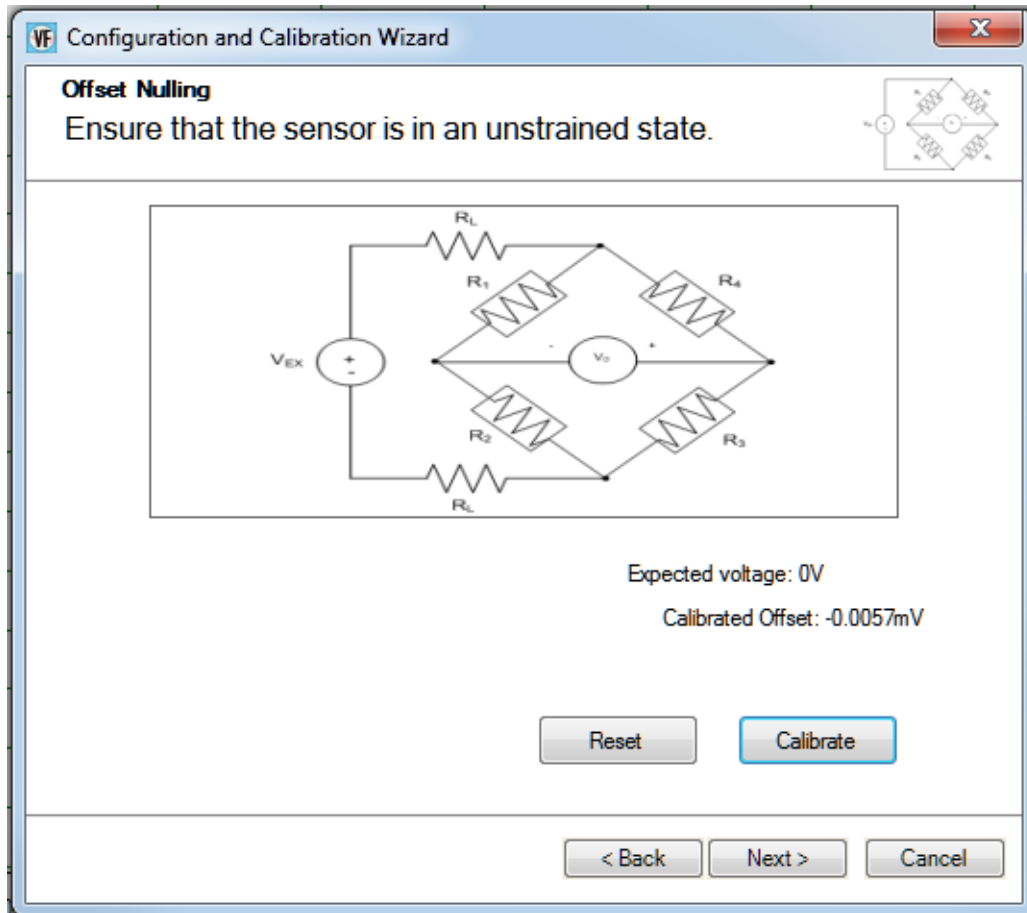

16. Click Next.

*A screen similar to the following appears:*

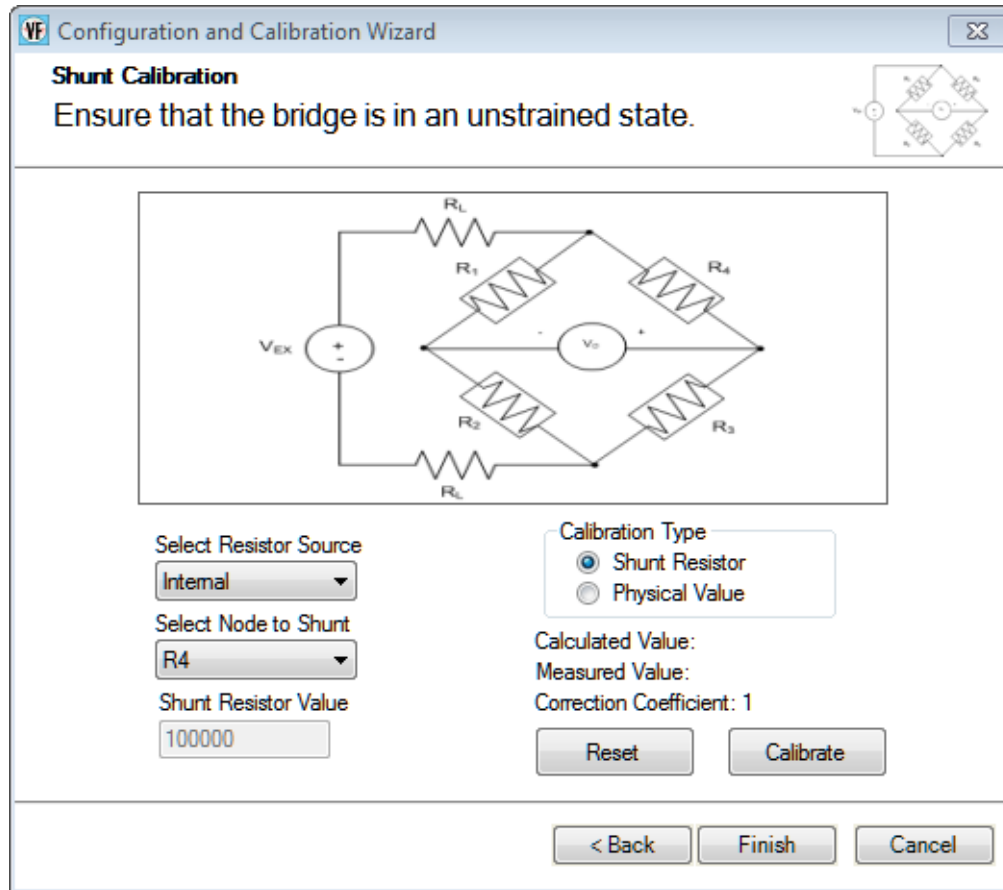

17. For the **Calibration Type**, select **Shunt Resistor** if you want to use a shunt resistor to perform the shunt calibration procedure or **Physical Value** if you want to enter a value to perform the shunt calibration procedure.  
*In this example, **Shunt Resistor** is used.*
18. For the **Select Resistor Source** field, select **Internal** if you are using the internal shunt resistor provided on the DT9838 module to perform shunt calibration, or **External** if you are using your own external resistor to perform shunt calibration.  
*In this example, **Internal** is used.*
19. For the **Select Node to Shunt** field, select the resistive node or element to which to apply the shunt resistor.  
*In this example, **R4** is used.*
20. Click **Calibrate** to perform the shunt calibration procedure.  
*The calculated value is displayed along with the measured value and correction coefficient.*

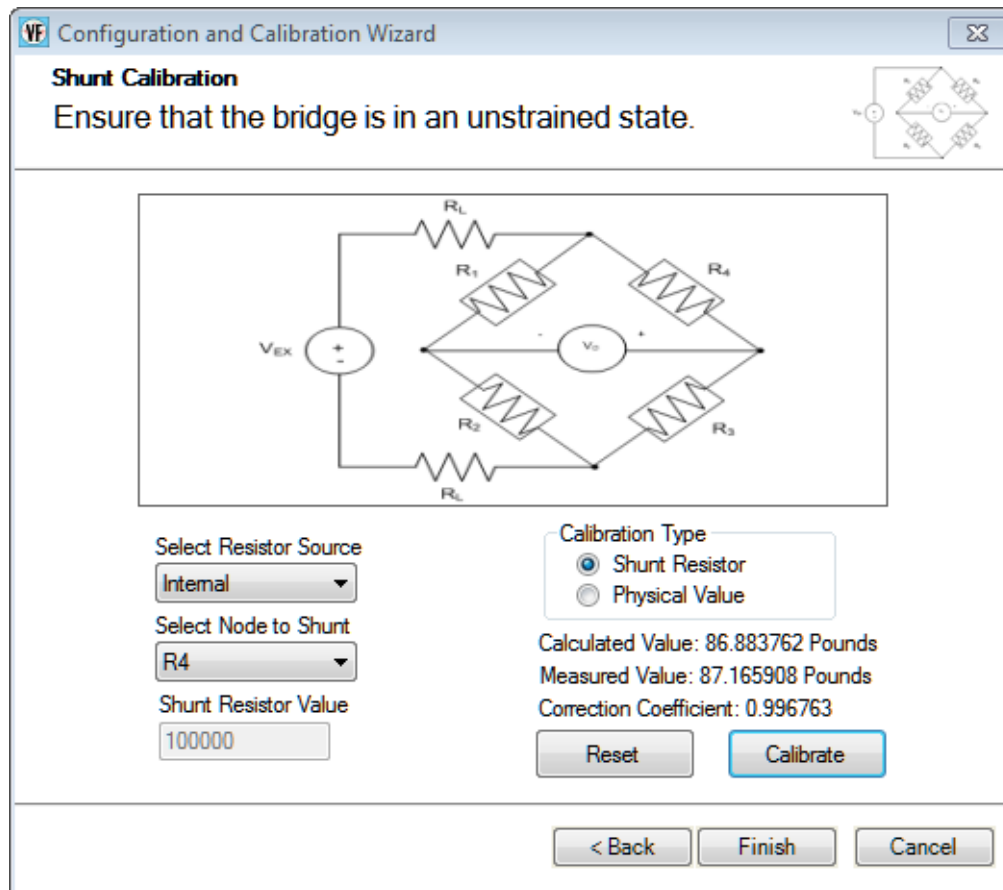

21. Click **Finish**.
22. If desired, enter a test point number under the **Point #** column.  
*In this example, 1 is used.*
23. Click **Close** to close the **Configure Devices** dialog box.

## Configure the Recording Settings

For this example, configure the recording settings as follows:

1. Click the **Recording** tab of the Acquisition Config window.

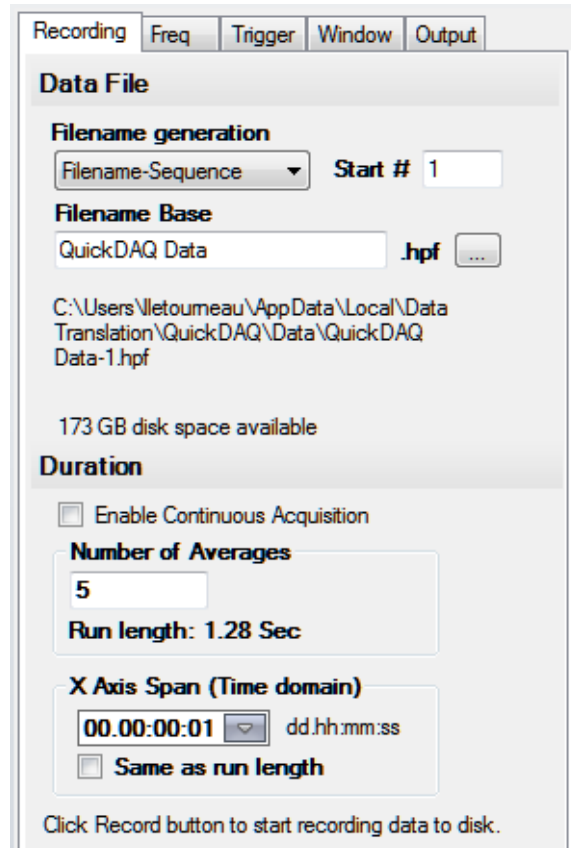

Recording Freq Trigger Window Output

**Data File**

**Filename generation**

Filename-Sequence Start # 1

**Filename Base**

QuickDAQ Data .hpf ...

C:\Users\Iletoumeau\AppData\Local\Data Translation\QuickDAQ\Data\QuickDAQ Data-1.hpf

173 GB disk space available

**Duration**

Enable Continuous Acquisition

**Number of Averages**

5

Run length: 1.28 Sec

**X Axis Span (Time domain)**

00.00:00:01 dd.hh:mm:ss

Same as run length

Click Record button to start recording data to disk.

2. For **Filename generation**, select **Filename**.
3. For **Filename**, use the default name for the data file.
4. Leave the **Enable Continuous Acquisition** checkbox unchecked.
5. For **Number of Averages**, enter 5 as the number of records to acquired, process, and average before acquisition stops.  
*The number of seconds for the total run and the amount of available disk space are shown.*
6. Select the span you want to use for the time-domain data on the x-axis.

## Configure the Frequency Settings

For this example, configure the frequency settings as follows:

1. Click the **Freq** tab of the Acquisition Config window.

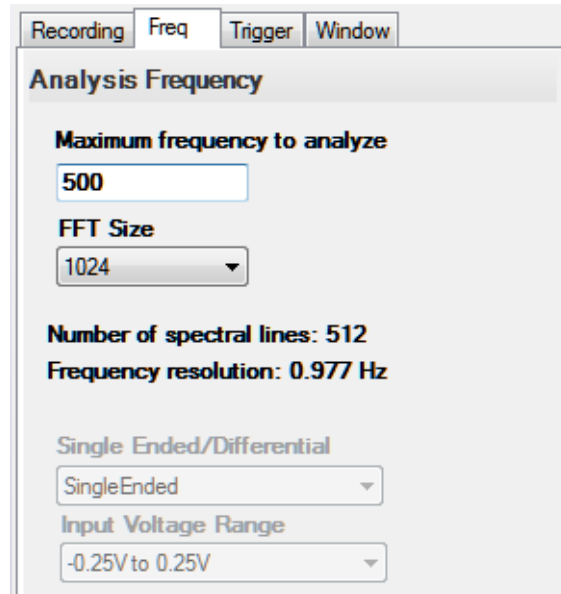

2. In the **Maximum frequency to analyze** text box, enter **500** as the bandwidth or span, in Hz, of the input signals that you want to analyze  
*Internally, the sampling rate of the data acquisition device is set to twice the bandwidth, or 1000 Hz in this example.*
3. In the **FFT Size** text box, select **1024** from the drop-down combo box as the number of data points to use for the FFT calculation.  
*The number of spectral lines and the frequency resolution are displayed.*

## Configure the Trigger Settings

For this example, configure the trigger settings as follows:

1. Click the **Trigger** tab of the Acquisition Config window.

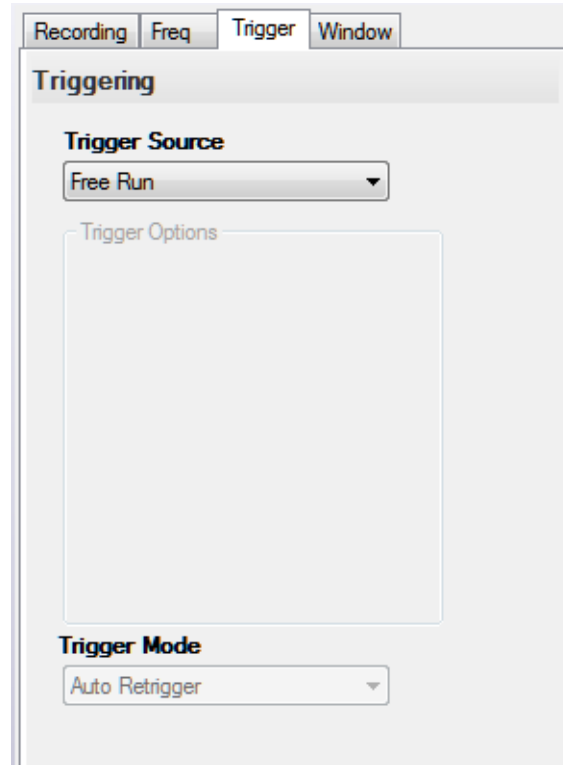

2. For the **Trigger Source**, select **Free Run** to ensure that the measurement starts as soon as the **Record** button is clicked.

## Start the Measurement

Once you have configured the channels, start acquisition and log data to disk by clicking the **Record** toolbar button (  **Record** ).

Results similar to the following are displayed in the Channel Plot window.

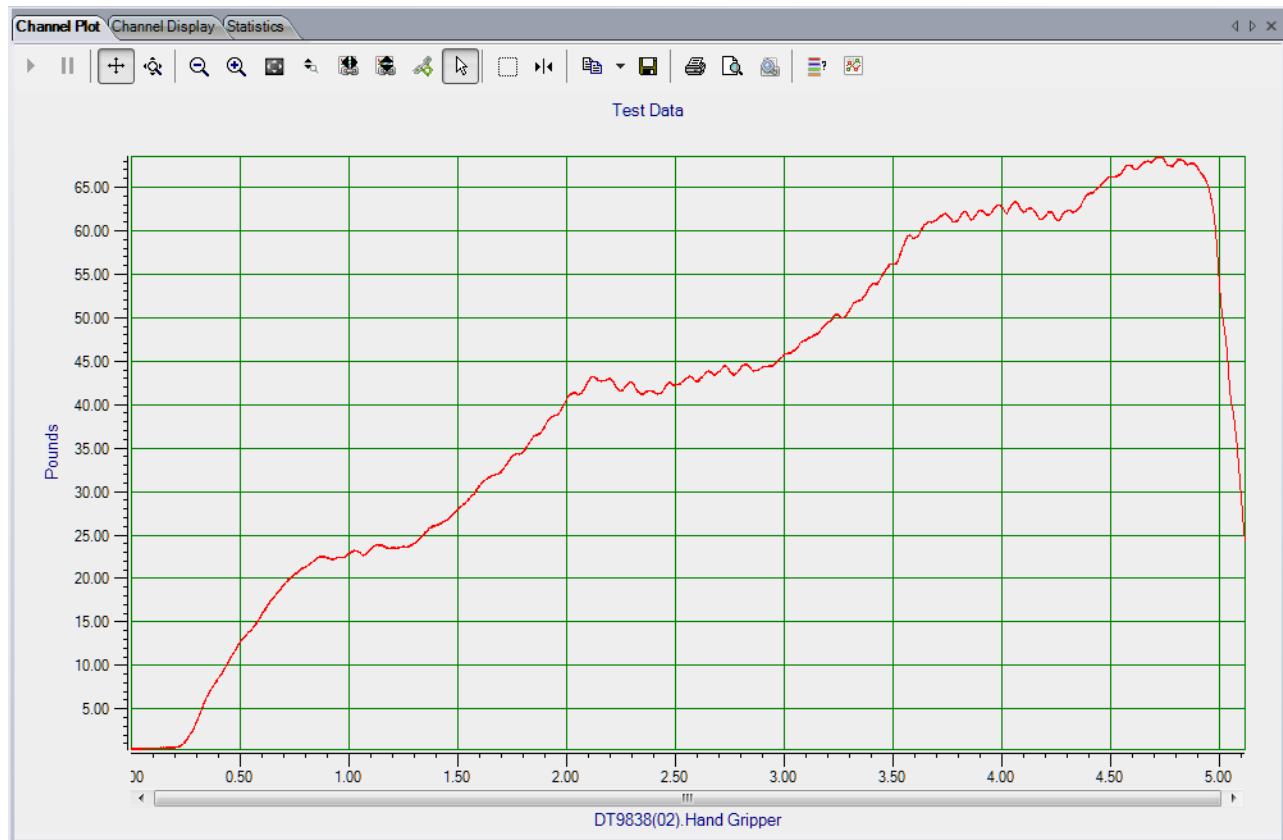

## Export the Data to Excel

You can export the acquired data to Microsoft Excel for further analysis by performing the following steps:

1. Click the **Open Current Data in Excel** toolbar button  .
2. Click **Time Series Data..**

*Microsoft Excel then opens and displays the data that was acquired, as shown in the following example.*

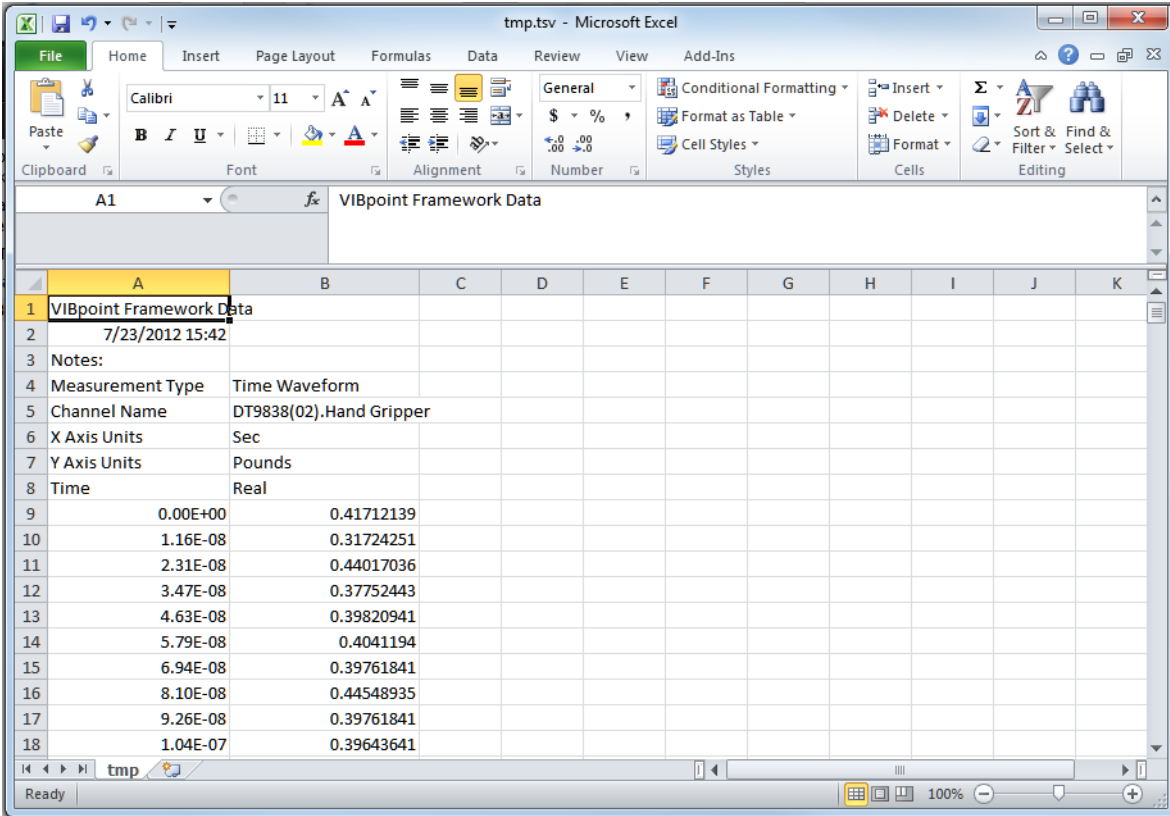

	A	B	C	D	E	F	G	H	I	J	K
1	VIBpoint Framework Data										
2	7/23/2012 15:42										
3	Notes:										
4	Measurement Type	Time Waveform									
5	Channel Name	DT9838(02).Hand Gripper									
6	X Axis Units	Sec									
7	Y Axis Units	Pounds									
8	Time	Real									
9	0.00E+00	0.41712139									
10	1.16E-08	0.31724251									
11	2.31E-08	0.44017036									
12	3.47E-08	0.37752443									
13	4.63E-08	0.39820941									
14	5.79E-08	0.4041194									
15	6.94E-08	0.39761841									
16	8.10E-08	0.44548935									
17	9.26E-08	0.39761841									
18	1.04E-07	0.39643641									



## Free Run Swept Sine Example

If you are using the Advanced FFT Analysis option of QuickDAQ, you can use the following steps to output a swept sine wave from an analog output channel while simultaneously acquiring data on the analog input channels in Free Run trigger mode. Both the waveform output and the analog input operations are continuous.

This example uses a DT9837A and the following equipment:

- The analog output channel of the DT9837A is connected to analog input channel 0 of the DT9837A and to an audio speaker.
- An accelerometer is attached to the audio speaker and connected to analog input channel 1 of the DT9837A.
- A microphone is positioned very close to the audio speaker and connected to analog input channel 2 of the DT9837A.

The FFT Analyzer interface is used.

### Configure the Channels

Configure the channels as follows:

1. Ensure that the proper signals are attached to the analog input channels of your data acquisition device.  
*In this example, the analog output signal is connected to analog input channel 0 and to the audio speaker, an accelerometer is attached to the audio speaker and connected to analog input channel 1, and the microphone is positioned close to the audio speaker and connected to analog input channel 2 of a DT9837A.*
2. Configure each analog input channel by clicking the **Input Channel Configuration** toolbar button (  ) or by clicking the **Configuration** menu and clicking **Input Channel Configuration**.
3. Enable analog input channel 0 by clicking the **Enable** checkbox for analog input channel 0.

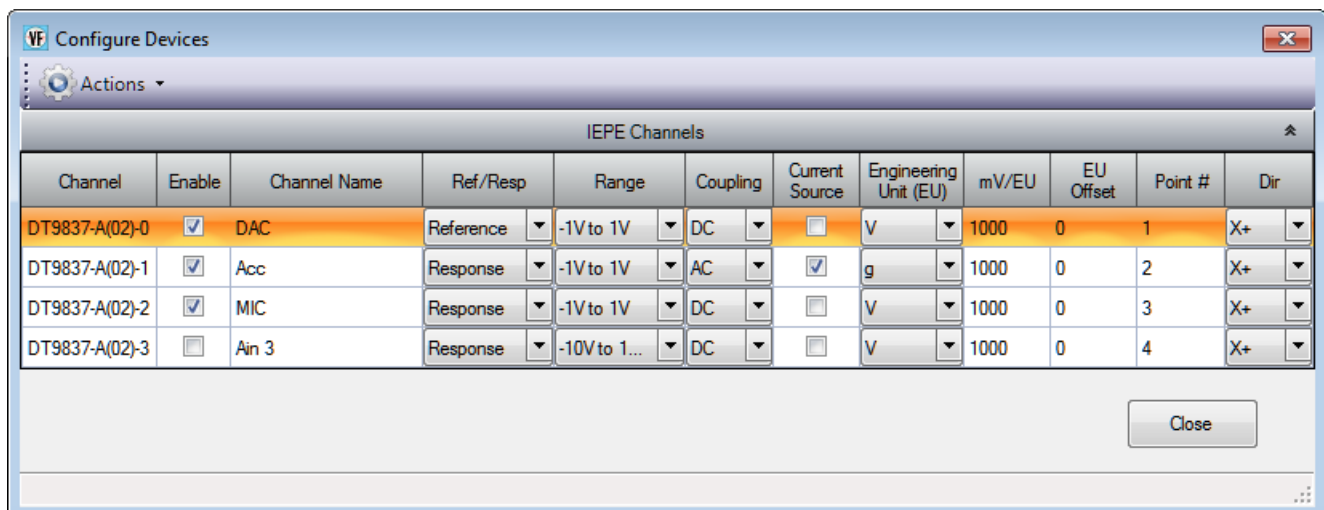

4. Under the **Channel Name** column, enter the following names for the analog input channels:
  - For analog input channel 0, enter **DAC**.
  - For analog input channel 1, enter **Acc**.
  - For analog input channel 2, enter **MIC**.
5. In the **Ref/Resp** column, select **Reference** for analog input channel 0 (DAC), and select **Response** for analog input channels 1 (Acc) and 2 (MIC).
6. Under the **Range** column, select the best effective input range ( $\pm 10$  V or  $\pm 1$  V) for each signal. For example, if your hammer and accelerometer measure 100 mV/g and your signal of interest is less than 100 g, choose the  $\pm 1$  V range; similarly, if your signal of interest is greater than 100 g, choose the  $\pm 10$  V range.  
*In this example,  $\pm 1$  V is used for analog input channels 0 (DAC), 1 (Acc), and 2 (MIC).*
7. Under the **Coupling** column, select the coupling type (AC or DC) for your sensor. For most IEPE accelerometers, you will want to choose **AC** coupling to remove any DC offset from your measurement. Choose **DC** coupling only if the signal source has no offset voltage or if the DC content of the acquired signal is important.  
*In this example, AC is used for analog input channel 1 (Acc), and DC is used for analog input channel 0 (DAC) and analog input channel 2 (MIC).*
8. Under the **Current Source** column, select whether to enable or disable use of the 4 mA current source on the data acquisition device. Since most IEPE accelerometers require a current source of 4 mA and a compliance voltage of at least 18 V to drive their internal circuitry, in most cases, you will want to enable use of the current source for each analog input channel.  
*In this example, the **Current Source** checkbox is checked (enabled) for analog input channel 1 (Acc) and is unchecked (disabled) for analog input channel 0 (DAC) and analog input channel 2 (MIC).*

---

**Note:** If you enable the use of the internal 4 mA excitation current source, it is recommended that you choose AC coupling.

---

9. Under the **Engineering Units** column, select the engineering units for the analog input channels.  
*In this example, V is used for analog input channel 0 (DAC) and analog input channel 2 (MIC), and g is used for analog input channel 1 (Acc).*
10. Using the calibration certificate that was supplied with your accelerometer, enter the calibrated sensitivity for the axis that is connected to the selected analog input channel in the **mV/EU** field.  
*In this example, 1000 mV/g is selected for analog input channel 1 (Acc).*
11. If an offset is specified for the accelerometer, enter the value in the **EU Offset** field.  
*In this example, no offset (0) is specified.*

12. If desired, enter a test point value for each channel.  
*In this example, the following values are used:*
  - Analog input channel 0 (DAC) = 1
  - Analog input channel 1 (Acc) = 2
  - Analog input channel 2 (MIC) = 3
13. If desired, enter a sensor direction for each channel.  
*In this example, the direction is not used (all analog input channels are X+).*
14. Click **Close** to close the Channel Configuration dialog box.

## Configure the Recording Settings

For this example, configure the recording settings as follows:

1. Click the **Recording** tab of the Acquisition Config window.

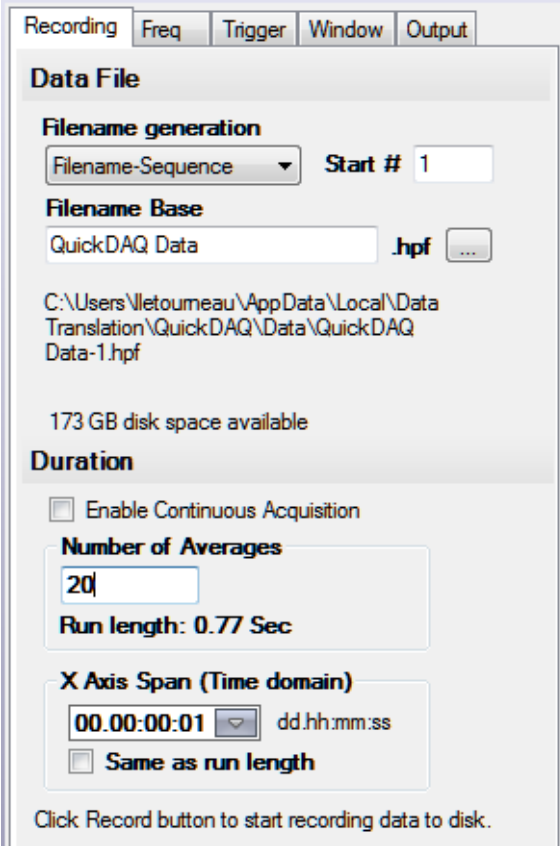

Recording Freq Trigger Window Output

**Data File**

**Filename generation**  
 Filename-Sequence Start # 1

**Filename Base**  
 QuickDAQ Data .hpf ...

C:\Users\Nletoumeau\AppData\Local\Data Translation\QuickDAQ\Data\QuickDAQ Data-1.hpf

173 GB disk space available

**Duration**

Enable Continuous Acquisition

**Number of Averages**  
 20  
 Run length: 0.77 Sec

**X Axis Span (Time domain)**  
 00:00:00:01 dd.hh:mm:ss  
 Same as run length

Click Record button to start recording data to disk.

2. For **Filename generation**, select the **Filename** option.
3. For **Filename**, use the default name for the data file.
4. Leave the **Enable Continuous Acquisition** checkbox unchecked.

- For **Number of Averages**, enter **20** as the number of records to acquire, process, and average before acquisition stops.  
*The number of seconds for the entire run and the amount of available disk space are shown.*
- Select the span you want to use for the time-domain data on the x-axis.

## Configure the Frequency Settings

For this example, configure the frequency settings as follows:

- Click the **Freq** tab of the Acquisition Config window.

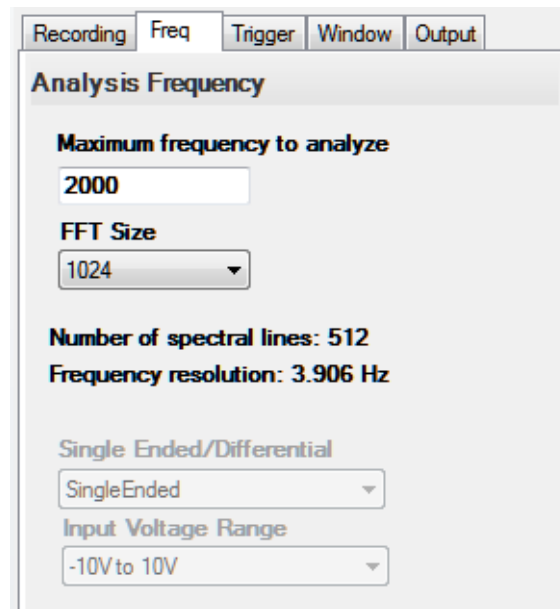

- In the **Maximum frequency to analyze** text box, enter **2000** as the bandwidth or span, in Hz, of the input signals that you want to analyze  
*Internally, the sampling rate of the data acquisition device is set to twice the bandwidth, or 4000 Hz in this example.*
- In the **FFT Size** text box, select **1024** from the drop-down combo box as the number of data points to use for the FFT calculation.  
*The number of spectral lines and the frequency resolution are displayed.*

## Configure the Trigger Settings

For this example, configure the trigger settings as follows:

1. Click the **Trigger** tab of the Acquisition Config window.

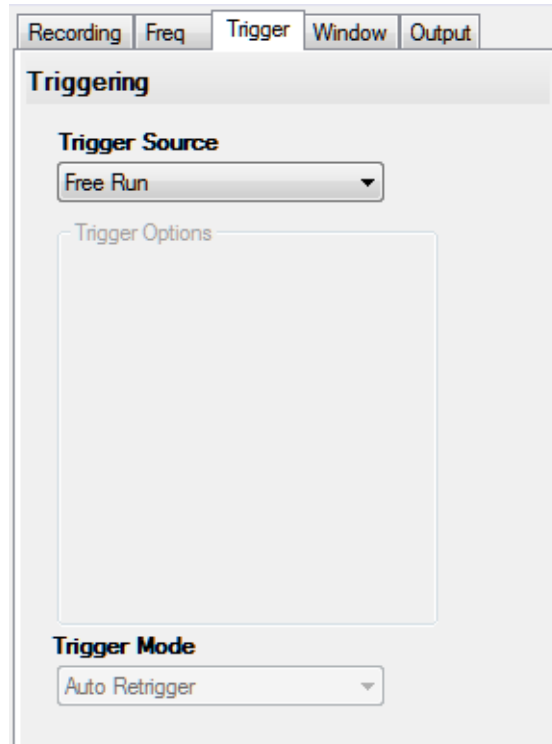

2. For the **Trigger Source**, select **Free Run**.

*This trigger setting ensures that the module acquires contiguous, gap-free, records when you click the **Record** button or press the **F5** key.*

## Configure the Windowing Function

For this example, configure the windowing function as follows:

1. Click the **Window** tab of the Acquisition and Config window.

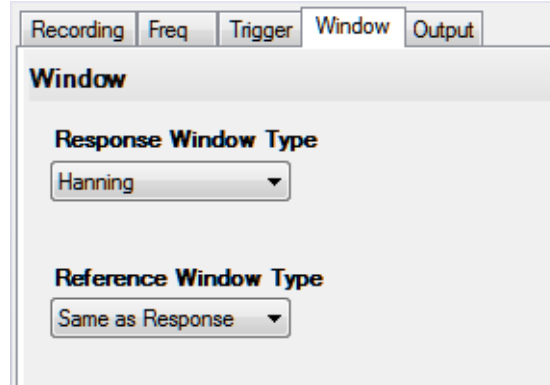

2. For the **Response Window Type**, select **Hanning**.  
*This is a global setting that is applied to the FFTs for all enabled analog input channels that are configured as response channels.*
3. For the **Reference Window Type**, select **Same as Response**.

## Configure the Analog Output Settings

For this example, configure the analog output channel as follows:

1. Click the **Output** tab of the Acquisition and Config window.

Recording	Freq	Trigger	Window	Output
<input checked="" type="checkbox"/>	DT9837-A(02...	Sweep	0.9	0

**Waveform**

**Sweep Mode**  
Single

**Start Frequency**  
100.00 Hz

**Freq Change**  
Log

**End Frequency**  
1500.00 Hz

**Options**

**Sweep On Time**  
5.1200 Sec

**Sweep Off Time**  
0.00000 Sec

Lock to acquisition time  
 Lock to analysis frame time

**Ramp Up Time**  
0.50000 Sec

**Ramp Down Time**  
0.01000 Sec



**Start/Stop Method**  
With Acquisition

**Trigger Source**  
Software

2. Select the **Enable** checkbox to enable the analog output channel on the device.
3. For the **Waveform** type, select **Sweep** to output a swept sine wave.
4. For the **Peak Voltage**, enter **0.9** as the maximum peak voltage for this waveform.  
*The maximum peak voltage of the output waveform will be  $\pm 0.9$  V.*
5. For the **Offset** value, enter 0.
6. For the **Sweep Mode**, select **Single** to output a single waveform.
7. For the **Freq Change**, select **Log** to output a waveform where the frequency increases at a fixed rate of octave change per time (Octave/s).
8. For the **Start Frequency**, enter 100 Hz; for the **End Frequency**, enter 1500 Hz.  
*The output sine wave will start at 100 Hz and sweep to 1500 Hz.*
9. Select the **Lock to acquisition time** checkbox.  
*The waveform will be output in the time that it takes to do all the averages (an acquisition of all the records specified in the **Recording** tab). Note that the **Sweep On Time** is set to the acquisition time, which in this case, is 5.12 s.*
10. For this example, leave the **Sweep Off Time** as **0 s**.  
*In this example, the output signal will be on for 5.12 s and then stop.*
11. For the **Ramp Up Time**, specify **0.5 s**; for the **Ramp Down Time**, specify **0.01 s**.  
*The signal will go up to specified peak voltage in 0.5 s and will go down to 0 V in 0.01 s.*
12. For the **Start/Stop Method**, select **With Acquisition**.  
*The analog output operations will start when you start acquisition.*
13. If desired, hide the Acquisition Config window by clicking the Auto-Hide pin (  ) in the top, right corner of the window.

## Add FFT Channels to the Plot and Data Config Window

The following steps show how to use the FFT Analyzer interface of QuickDAQ to add three FFT channels to the Plot and Data Config window:

1. Click the **Add single channel FFT function** (  ) button and select **DT9837-A(02).DAC**.  
*The DAC-FFT channel is added to the Plot and Data Config window.*
2. Click the **Add single channel FFT function** (  ) button and select **DT9837-A(02).Acc**.  
*The Acc-FFT channel is added to the Plot and Data Config window.*
3. Click the **Add single channel FFT function** (  ) button and select **DT9837-A(02).MIC**.  
*The MIC-FFT channel is added to the Plot and Data Config window.*



## Configure the FFT Channels

The following steps show how to use the FFT Analyzer interface of QuickDAQ to configure the parameters used for the FFT channel:

1. Under the **Channel Name** column in the Plot and Data Config window, hold down the **Ctrl** key and select the FFT channels (**DAC-FFT**, **Acc-FFT**, and **MIC-FFT** in this example) that you want to configure.
2. Click the **Data** tab, and then click the **Function** tab.

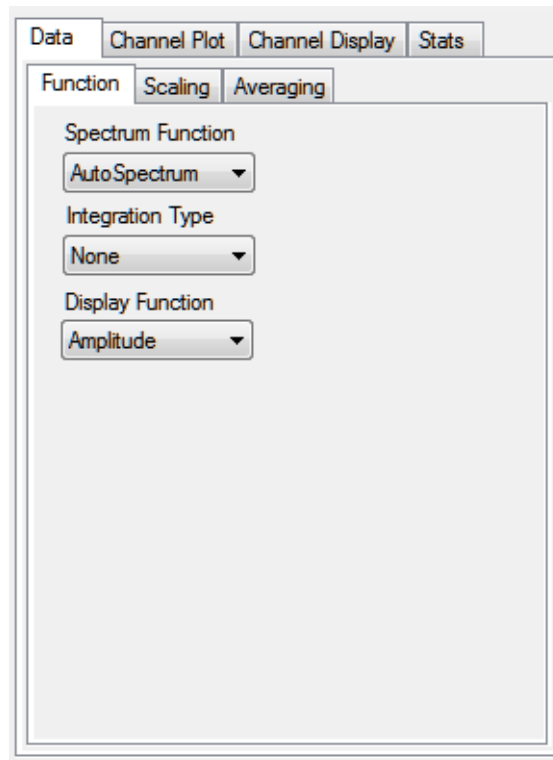

3. For this example, configure the settings of this tab as follows:
  - a. For **Spectrum Function**, select **AutoSpectrum**.
  - b. For **IntegrationType**, select **None**.
  - c. For **Display Function**, select **Amplitude**.

4. Click the **Scaling** tab, and configure the settings of this tab as follows:
  - a. For **dB/Linear**, select **Linear**.
  - b. For **RMS/Peak/PkPk**, select **RMS**.

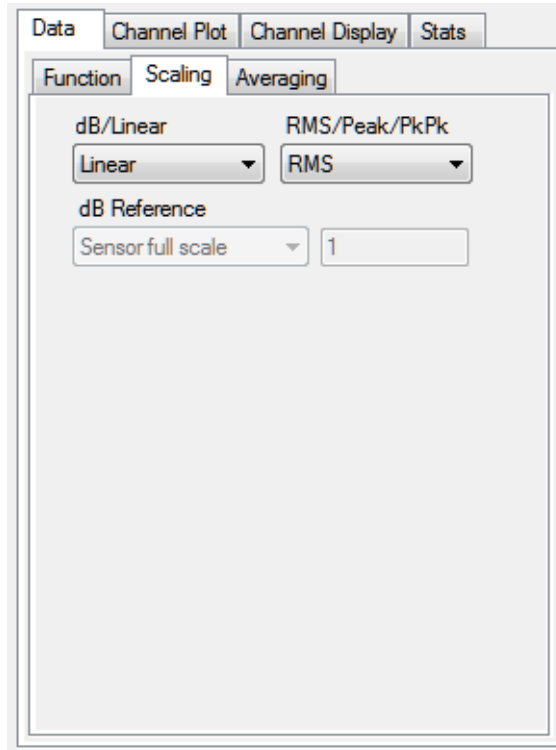

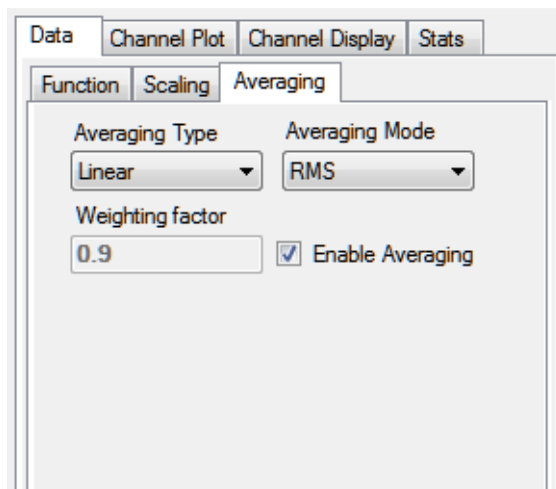

5. Click the **Averaging** tab, and configure the settings of this tab as follows:
  - a. Select the **Enable Averaging** checkbox.
  - b. For **Averaging Type**, select **Linear**.
  - c. For **Averaging Mode**, select **RMS**.



## Add FRF Channels to the Plot and Data Config Window

The following steps show how to use the FFT Analyzer interface of QuickDAQ to add two FRF channels to the Plot and Data Config window to calculate the frequency response of analog input channel 0 (DAC) and analog input channel 1 (Acc), and analog input channel 0 (DAC) and analog input channel 2 (MIC).

1. Click the **Add 2 channel FFT function** (  ) button, select **FRF**, and select **DT9837-A(02).Acc**.  
*The Acc-FRF channel is added to the Plot and Data Config window.*
2. Click the **Add 2 channel FFT function** (  ) button, select **FRF**, and select **DT9837-A(02).MIC**.  
*The MIC-FRF channel is added to the Plot and Data Config window.*

## Configure the FRF Channels

The following steps show how to use the FFT Analyzer interface of QuickDAQ to configure the parameters used to generate the FRF channels for the analog input channels:

1. Under the **Channel Name** column in the Plot and Data Config window, hold down the **Ctrl** key and select the FRF channels (**Acc-FRF** and **MIC-FRF** in this example) that you want to configure.
2. Click the **Data** tab, and then click the **Function** tab.

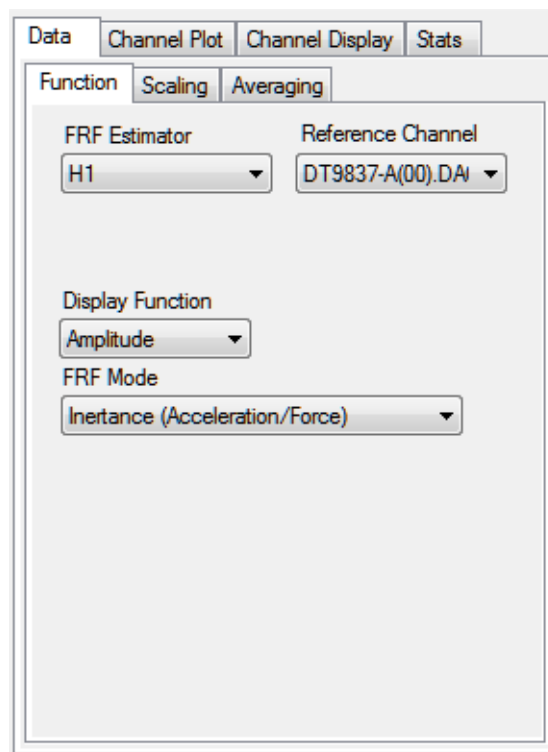

3. For the **Acc-FRF** channel, configure the settings of this tab as follows:
  - a. For **FRF Estimator**, select **H1** (reduces noise on the response channel).
  - b. For **Reference Channel**, select **DAC** (analog input channel 0).
  - c. For **Display Function**, select **Amplitude**.
  - d. For **FRF Mode**, select **Inertance (Acceleration/Force)**.
4. Click the **Scaling** tab, and select **Linear** for **dB/Linear**:

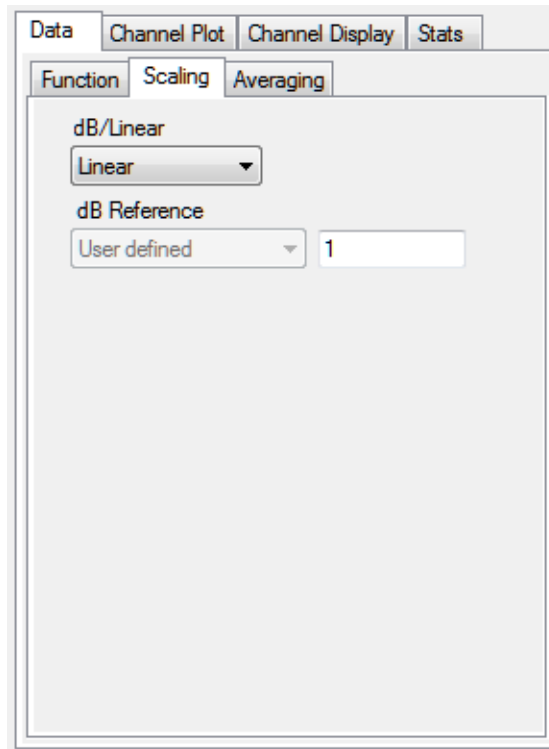

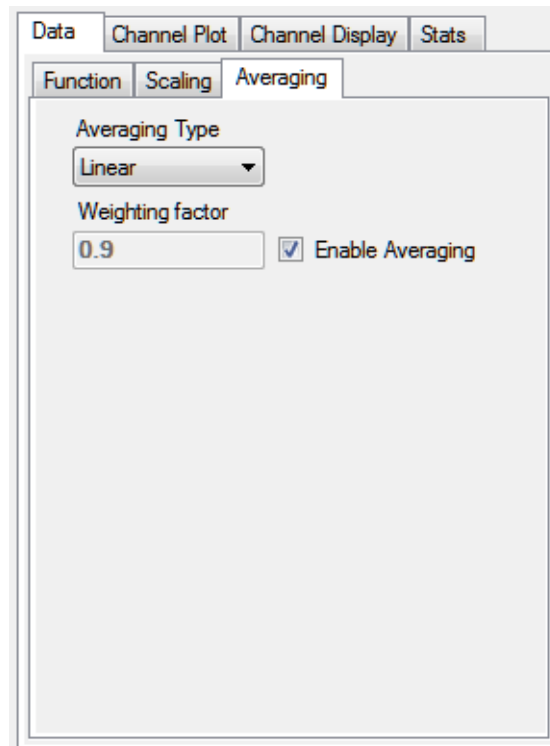

5. Click the **Averaging** tab, select the **Enable Averaging** checkbox, and select **Linear** for **Averaging Type**:



## Add Coherence Channels to the Plot and Data Config Window

The following steps show how to use the FFT Analyzer interface of QuickDAQ to add two Coherence channels to the Plot and Data Config window:

1. Click the **Add 2 channel FFT function** (  ) button, select **Coherence** and select **DT9837-A(02).Acc**.  
*The Acc-Coherence channel is added to the Plot and Data Config window.*
2. Click the **Add 2 channel FFT function** (  ) button, select **Coherence**, and select **DT9837-A(02).MIC**.  
*The MIC-Coherence channel is added to the Plot and Data Config window.*

## Configure the Coherence Channel

The following steps show how to use the FFT Analyzer interface of QuickDAQ to configure the parameters used to generate the Coherence channel for the analog input channels:

1. Under the **Channel Name** column in the Plot and Data Config window, hold down the **Ctrl** key and select the Coherence channels (**Acc-Coherence** and **MIC-Coherence** in this example) that you want to configure.
2. Click the **Data** tab, and then click the **Function** tab.

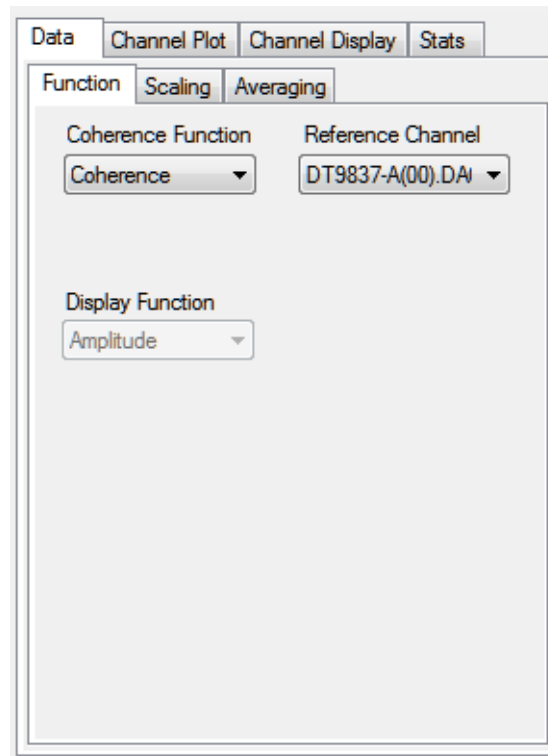

3. For this example, configure the settings of this tab as follows:
  - a. For **Coherence Function**, select **Coherence**.
  - b. For **Reference Channel**, select **DAC** (analog input channel 0).

---

**Note:** **Linear** scaling is selected automatically for Coherence channels under the **Scaling** tab.

---

4. Click the **Averaging** tab, and select **Linear** for **Averaging Type**:

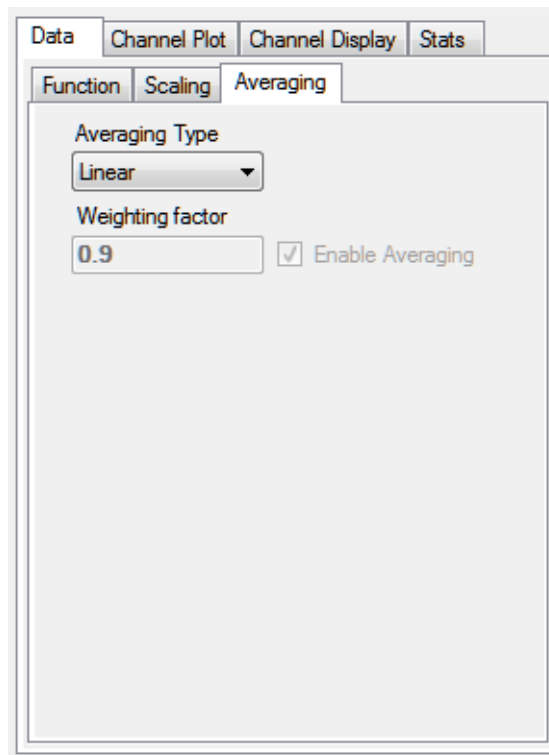

## Configure the Appearance of the Channel Plot Window

Perform the following steps to configure the appearance of the Channel Plot window:

1. Select the **Visible Plot** checkbox for the DAC, DAC-FFT, MIC, MIC-Coherence, MIC-FRF, and MIC-FFT channels.

Channel Name	Visible Plot	Visible Display	Visible Statistics	Show Cursor	Plot Column	Signal Group	Color
DT9837-A(02).DAC	<input checked="" type="checkbox"/>	<input checked="" type="checkbox"/>	<input checked="" type="checkbox"/>	<input type="checkbox"/>	1	A	
DT9837-A(02).DAC-FFT	<input checked="" type="checkbox"/>		<input type="checkbox"/>	<input type="checkbox"/>	1	None	
DT9837-A(02).Acc	<input type="checkbox"/>	<input checked="" type="checkbox"/>	<input checked="" type="checkbox"/>	<input type="checkbox"/>	1	None	
DT9837-A(02).Acc-FFT	<input type="checkbox"/>		<input type="checkbox"/>	<input type="checkbox"/>	1	None	
DT9837-A(02).Acc-FRF	<input type="checkbox"/>		<input type="checkbox"/>	<input type="checkbox"/>	1	None	
DT9837-A(02).Acc-Cohere...	<input type="checkbox"/>		<input type="checkbox"/>	<input type="checkbox"/>	1	None	
DT9837-A(02).MIC	<input checked="" type="checkbox"/>	<input checked="" type="checkbox"/>	<input checked="" type="checkbox"/>	<input type="checkbox"/>	1	A	
DT9837-A(02).MIC-FFT	<input checked="" type="checkbox"/>		<input type="checkbox"/>	<input type="checkbox"/>	1	None	
DT9837-A(02).MIC-FRF	<input checked="" type="checkbox"/>		<input type="checkbox"/>	<input checked="" type="checkbox"/>	2	None	
DT9837-A(02).MIC-Cohere...	<input checked="" type="checkbox"/>		<input type="checkbox"/>	<input type="checkbox"/>	2	None	

2. Select the **Show Cursor** checkbox for the MIC-FRF channel.
3. Under **Plot Column**, select plot column 1 for the DAC, DAC-FFT, MIC, and MIC-FFT channels, and select plot column 2 for the MIC-Coherence and MIC-FRF channels.
4. Under the **Signal Group** column, select group A for the DAC and MIC channels, and leave **None** as the signal group for the rest of the channels.
5. Assign a unique color to each trace for the visible channels.
6. Click the **Channel Plot - Control** tab.



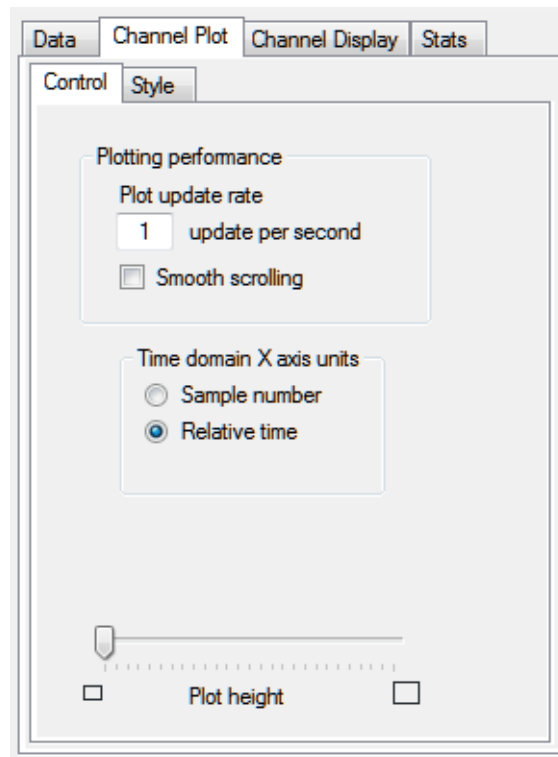

7. Slide the **Plot height** bar to the left until you can see all 5 plots on the Channel Plot window at once.

## Start the Simultaneous Swept Sine and Analog Input Operation

Once you have configured the channels and the parameters for the Channel Plot window, click the **Record** toolbar button (  ) or press the **F5** key.

You will hear the waveform as it is output from the audio speaker as it sweeps from 100 Hz to 1500 Hz. Results similar to the following are displayed in the Channel Plot window.

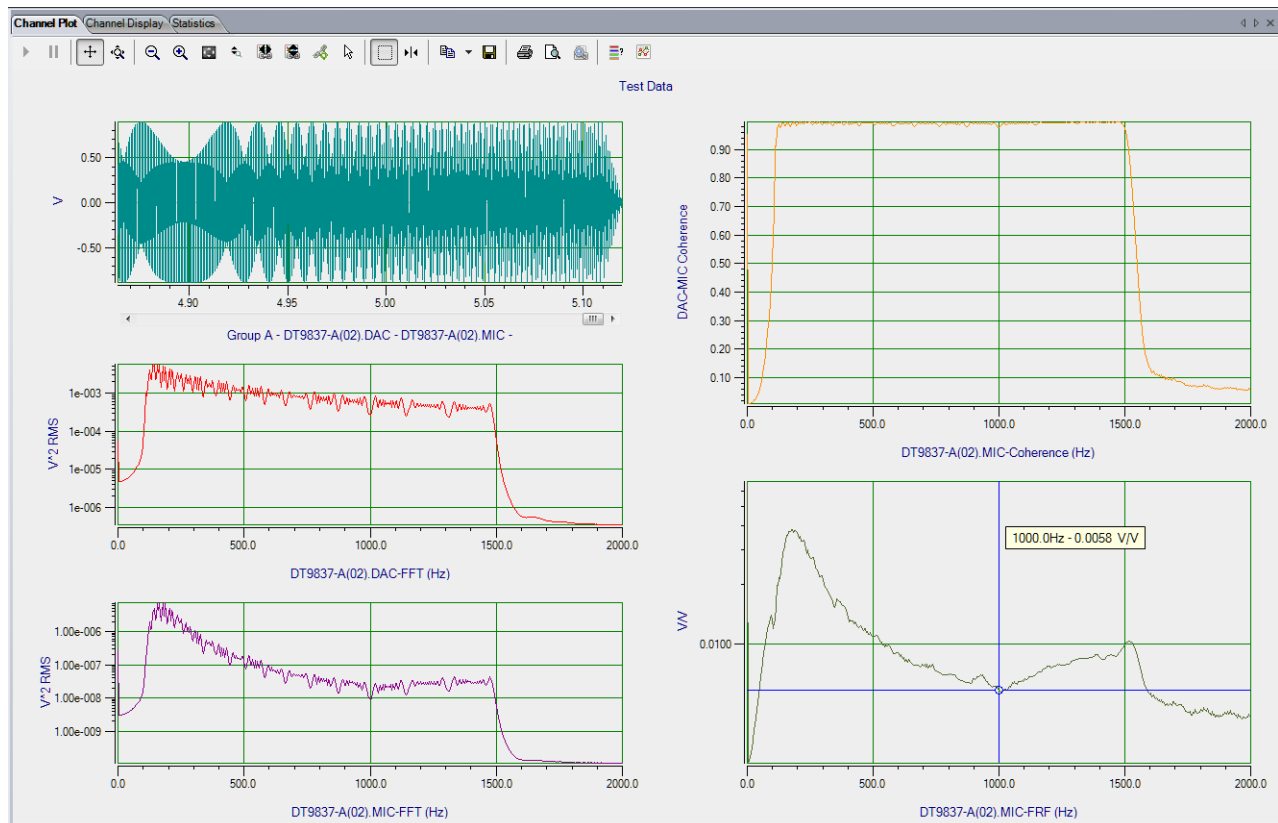

In column 1, you can see the signal that is output from the analog output channel (DAC) and read in as analog input channel 0, and the signal that is measured by the microphone (MIC); this is Group A of the first plot. You can also see the FFT of the analog output channel (DAC) and the FFT of the microphone (MIC).

In column 2, you can see the coherence of the microphone (MIC) and the FRF of the microphone (MIC). In this example, the y-axis of the FRF plot is shown in log10 format (right-click the y-axis, select **Y-Axis Setup...**, and select **Log10** for **Lin/Log**).

---

**Note:** If desired, you can show the data for the Acc, Acc-FFT, Acc-FRF, and Acc-Coherence channels by selecting the **Visible Plot** checkbox in the Channel Plot window.

---

## Triggered Burst Random Example

If you are using the Advanced FFT Analysis option of QuickDAQ, you can use the following steps to output multiple burst random waveforms while simultaneously acquiring data on the analog input channels in Software trigger mode. The duration of each burst random signal corresponds to the duration of one analysis record. Between each burst, the analog input and analog output operations stop, wait the specified delay time, and then repeat the burst.

This example uses a DT9837A and the following equipment:

- The analog output channel of the DT9837A is connected to analog input channel 0 of the DT9837A and to an audio speaker.
- An accelerometer is attached to the audio speaker and connected to analog input channel 1 of the DT9837A.
- A microphone is positioned very close to the audio speaker and connected to analog input channel 2 of the DT9837A.

The FFT Analyzer interface is used.

### Configure the Channels

Configure the channels as follows:

1. Ensure that the proper signals are attached to the analog input channels of your data acquisition device.  
*In this example, the analog output signal is connected to analog input channel 0 and to the audio speaker, an accelerometer is attached to the audio speaker and connected to analog input channel 1, and the microphone is positioned close to the audio speaker and connected to analog input channel 2 of a DT9837A.*
2. Configure each analog input channel by clicking the **Input Channel Configuration** toolbar button (  ) or by clicking the **Configuration** menu and clicking **Input Channel Configuration**.

3. Enable analog input channel 0 by clicking the **Enable** checkbox for analog input channel 0.

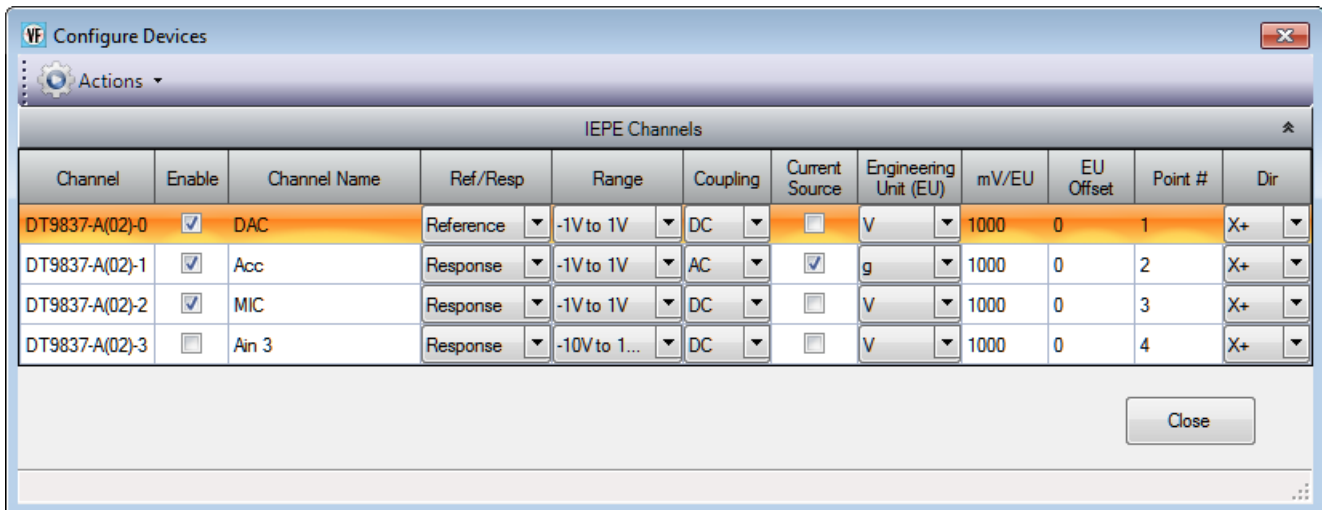

4. Under the **Channel Name** column, enter the following names for the analog input channels:
  - For analog input channel 0, enter **DAC**.
  - For analog input channel 1, enter **Acc**.
  - For analog input channel 2, enter **MIC**.
5. In the **Ref/Resp** column, select **Reference** for analog input channel 0 (DAC), and select **Response** for analog input channels 1 (Acc) and 2 (MIC).
6. Under the **Range** column, select the best effective input range ( $\pm 10$  V or  $\pm 1$  V) for each signal. For example, if your hammer and accelerometer measure 100 mV/g and your signal of interest is less than 100 g, choose the  $\pm 1$  V range; similarly, if your signal of interest is greater than 100 g, choose the  $\pm 10$  V range.  
*In this example,  $\pm 1$  V is used for analog input channels 0 (DAC), 1 (Acc), and 2 (MIC).*
7. Under the **Coupling** column, select the coupling type (AC or DC) for your sensor. For most IEPE accelerometers, you will want to choose **AC** coupling to remove any DC offset from your measurement. Choose **DC** coupling only if the signal source has no offset voltage or if the DC content of the acquired signal is important.  
*In this example, AC is used for analog input channel 1 (Acc), and DC is used for analog input channel 0 (DAC) and analog input channel 2 (MIC).*
8. Under the **Current Source** column, select whether to enable or disable use of the 4 mA current source on the data acquisition device. Since most IEPE accelerometers require a current source of 4 mA and a compliance voltage of at least 18 V to drive their internal circuitry, in most cases, you will want to enable use of the current source for each analog input channel.  
*In this example, the **Current Source** checkbox is checked (enabled) for analog input channel 1 (Acc) and is unchecked (disabled) for analog input channel 0 (DAC) and analog input channel 2 (MIC).*

---

**Note:** If you enable the use of the internal 4 mA excitation current source, it is recommended that you choose AC coupling.

---

9. Under the **Engineering Units** column, select the engineering units for the analog input channels.  
*In this example, V is used for analog input channel 0 (DAC) and analog input channel 2 (MIC), and g is used for analog input channel 1 (Acc).*
10. Using the calibration certificate that was supplied with your accelerometer, enter the calibrated sensitivity for the axis that is connected to the selected analog input channel in the **mV/EU** field.  
*In this example, 1000 mV/g is selected for analog input channel 1 (Acc).*
11. If an offset is specified for the accelerometer, enter the value in the **EU Offset** field.  
*In this example, no offset (0) is specified.*
12. If desired, enter a test point value for each channel.  
*In this example, the following values are used:*
  - Analog input channel 0 (DAC) = 1
  - Analog input channel 1 (Acc) = 2
  - Analog input channel 2 (MIC) = 3
13. If desired, enter a sensor direction for each channel.  
*In this example, the direction is not used (all analog input channels are X+).*
14. Click **Close** to close the Channel Configuration dialog box.

## Configure the Recording Settings

For this example, configure the recording settings as follows:

1. Click the **Recording** tab of the Acquisition Config window.

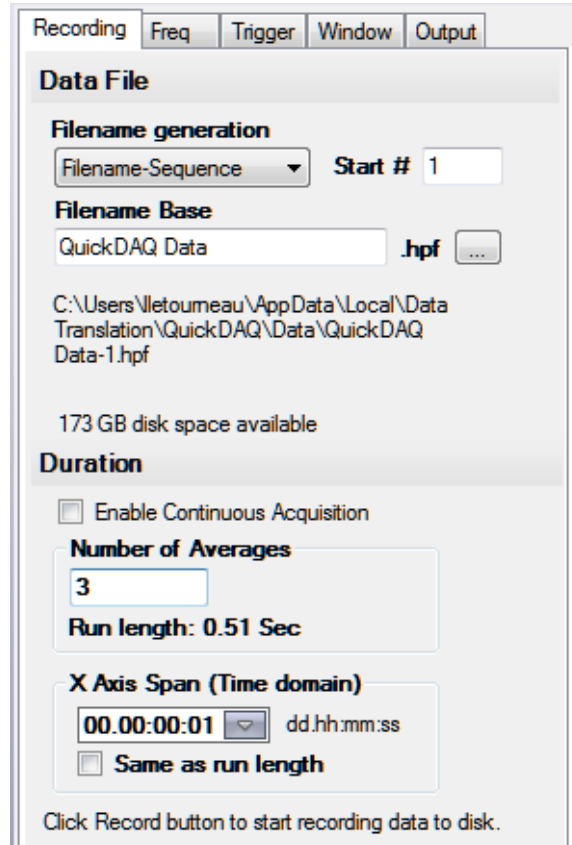

Recording | Freq | Trigger | Window | Output

**Data File**

**Filename generation**  
 Filename-Sequence Start # 1

**Filename Base**  
 QuickDAQ Data .hpf ...

C:\Users\iletoumeau\AppData\Local\Data Translation\QuickDAQ\Data\QuickDAQ Data-1.hpf

173 GB disk space available

**Duration**

Enable Continuous Acquisition

**Number of Averages**  
 3

Run length: 0.51 Sec

**X Axis Span (Time domain)**  
 00:00:00:01 dd.hh:mm:ss

Same as run length

Click Record button to start recording data to disk.

2. For **Filename generation**, select the **Filename** option.
3. For **Filename**, use the default name for the data file.
4. Leave the **Enable Continuous Acquisition** checkbox unchecked.
5. For **Number of Averages**, enter **3** as the number of records to acquire, process, and average before acquisition stops.  
*The number of seconds for the entire run and the amount of available disk space are shown.*
6. Select the span you want to use for the time-domain data on the x-axis.

## Configure the Frequency Settings

For this example, configure the frequency settings as follows:

1. Click the **Freq** tab of the Acquisition Config window.

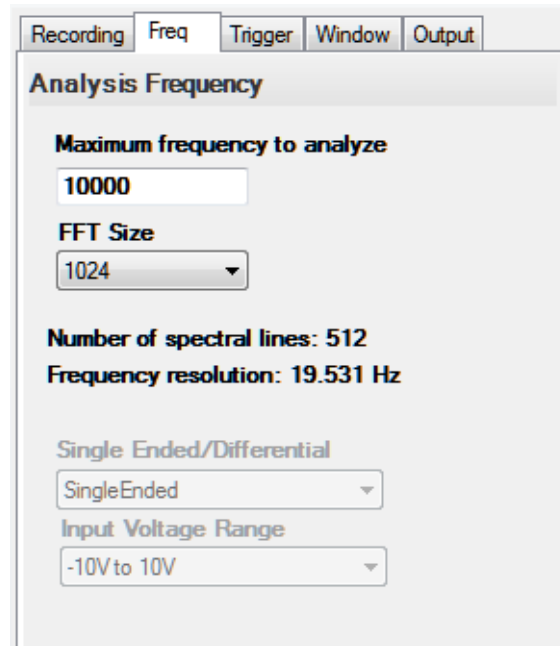

2. In the **Maximum frequency to analyze** text box, enter **10000** as the bandwidth or span, in Hz, of the input signals that you want to analyze  
*Internally, the sampling rate of the data acquisition device is set to twice the bandwidth, or 20000 Hz in this example.*
3. In the **FFT Size** text box, select **1024** from the drop-down combo box as the number of data points to use for the FFT calculation.  
*The number of spectral lines and the frequency resolution are displayed.*

## Configure the Trigger Settings

For this example, configure the trigger settings as follows:

1. Click the **Trigger** tab of the Acquisition Config window.

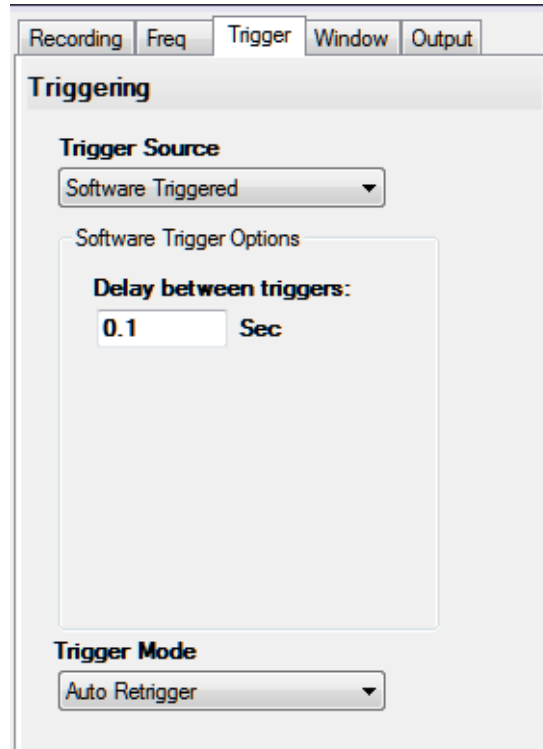

2. For the **Trigger Source**, select **Software Triggered**.
3. For the **Trigger Mode**, select **Auto Retrigger**.
4. For **Delay between triggers**, enter **0.1 s**.

*With these trigger settings, once you click the **Record** button or press the **F5** key, the module acquires a record based on a internal software trigger, waits 0.1 second, and then acquires the next record based on the internal software trigger.*



## Configure the Windowing Function

For this example, configure the windowing function as follows:

1. Click the **Window** tab of the Acquisition and Config window.

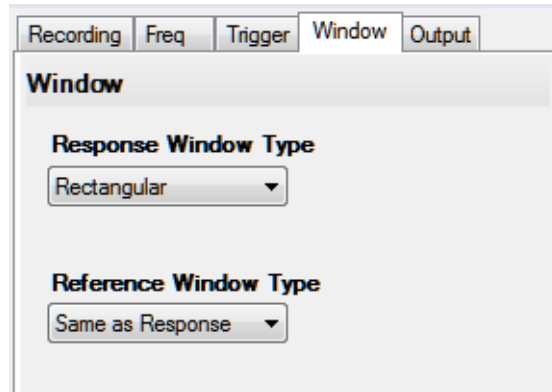

2. For the **Response Window Type**, select **Rectangular**.  
*This is a global setting that is applied to the FFTs for all enabled analog input channels that are configured as response channels.*
3. For the **Reference Window Type**, select **Same as Response**.

## Configure the Analog Output Settings

For this example, configure the analog output channel as follows:

1. Click the **Output** tab of the Acquisition and Config window.

Recording	Freq	Trigger	Window	Output
<input checked="" type="checkbox"/>	DT9837-A(02...	Noise	0.9	0

### Waveform

<b>Noise Type</b> Random	<b>Repeat Method</b> True Random
<b>Output Mode</b> Burst	<b>Start Frequency</b> 0.00 Hz
<input type="checkbox"/> Repeat burst	<b>End Frequency</b> 8000.00 Hz
<input type="checkbox"/> Lock to analysis freq	

### Options

<b>Noise On Time</b> 0.51200 Sec	<b>Noise Off Time</b> 0.00000 Sec
<input type="checkbox"/> Lock to acquisition time	<input checked="" type="checkbox"/> Lock to analysis frame time
<b>Ramp Up Time</b> 0.01000 Sec	<b>Ramp Down Time</b> 0.01000 Sec

**Start/Stop Method**  
With Acquisition

**Trigger Source**  
Software

2. Select the **Enable** checkbox to enable the analog output channel on the device.
3. For the **Waveform** type, select **Noise** to output a noise waveform.

---



**Note:** To output a burst chirp signal, select **Sweep** instead of **Noise** to output a swept sine wave rather than a noise output signal.

---

4. For the **Peak Voltage**, enter **0.9** as the maximum peak voltage for this waveform.  
*The maximum peak voltage of the output waveform will be  $\pm 0.9$  V.*
5. For the **Offset** value, enter 0.
6. For the **Noise Type**, select **Random** to output white noise that is created with a software generator function.
7. For the **Output Mode**, select **Burst** to output the waveform for a specified time.
8. For the **Start Frequency**, select **0 Hz**; this is the starting frequency component of the output waveform.
9. For the **End Frequency**, select **8000 Hz**; this is the ending frequency component of the output waveform.
10. For the **Repeat Method**, select **True Random** to generate a new random noise signal for each burst period.
11. Select the **Lock to analysis frame time** checkbox.  
*The waveform will be output in the time that it takes to do one average (an acquisition of one record). Note that the **Noise On Time** is set to the analysis frame time, which in this case, is 0.5120 s.*
12. For this example, leave the **Noise Off Time** as **0 s**.  
*In this example, the output signal will be on for 0.5120 s and then stop.*
13. For the **Ramp Up Time**, specify **0.01 s**; for the **Ramp Down Time**, specify **0.01 s**.  
*The signal will go up to specified peak voltage in 0.01 s and will go down to 0 V in 0.01 s.*
14. For the **Start/Stop Method**, select **With Acquisition**.  
*The analog output operations will start when you start acquisition.*
15. If desired, hide the Acquisition Config window by clicking the Auto-Hide pin (  ) in the top, right corner of the window.

## Add FFT Channels to the Plot and Data Config Window

The following steps show how to use the FFT Analyzer interface of QuickDAQ to add three FFT channels to the Plot and Data Config window:

1. Click the **Add single channel FFT function** (  ) button and select **DT9837-A(02).DAC**.  
*The DAC-FFT channel is added to the Plot and Data Config window.*
2. Click the **Add single channel FFT function** (  ) button and select **DT9837-A(02).Acc**.  
*The Acc-FFT channel is added to the Plot and Data Config window.*
3. Click the **Add single channel FFT function** (  ) button and select **DT9837-A(02).MIC**.  
*The MIC-FFT channel is added to the Plot and Data Config window.*

## Configure the FFT Channels

The following steps show how to use the FFT Analyzer interface of QuickDAQ to configure the parameters used for the FFT channel:

1. Under the **Channel Name** column in the Plot and Data Config window, hold down the **Ctrl** key and select the FFT channels (**DAC-FFT**, **Acc-FFT**, and **MIC-FFT** in this example) that you want to configure.
2. Click the **Data** tab, and then click the **Function** tab.

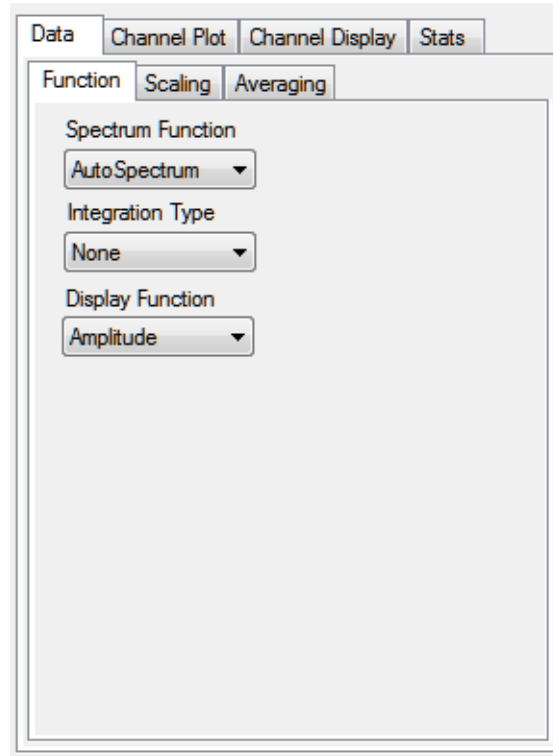

3. For this example, configure the settings of this tab as follows:
  - a. For **Spectrum Function**, select **AutoSpectrum**.
  - b. For **Integration Type**, select **None**.
  - c. For **Display Function**, select **Amplitude**.
4. Click the **Scaling** tab, and configure the settings of this tab as follows:
  - a. For **dB/Linear**, select **Linear**.
  - b. For **RMS/Peak/PkPk**, select **RMS**.

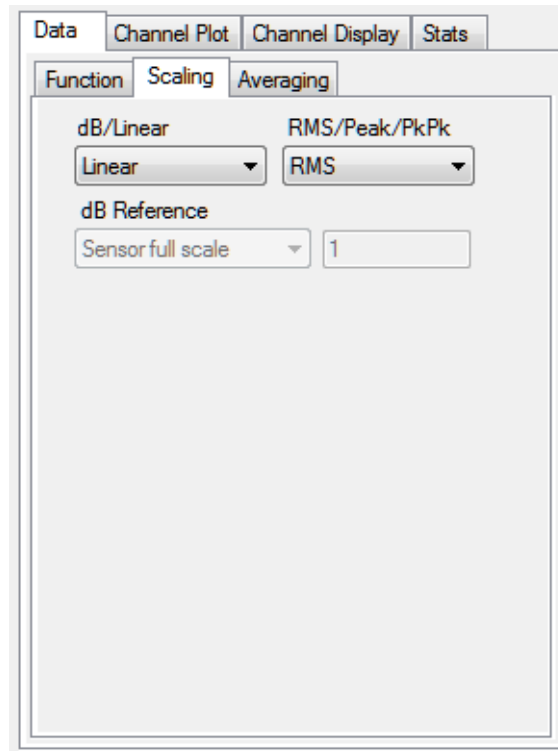

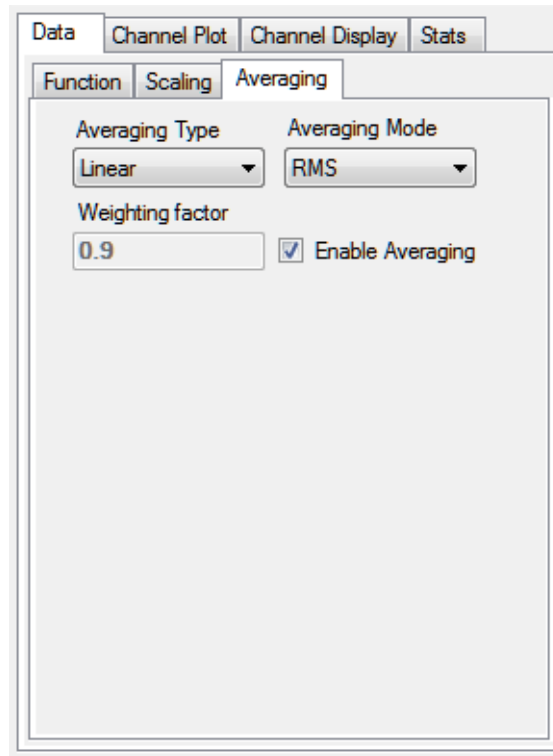

5. Click the **Averaging** tab, and configure the settings of this tab as follows:
  - a. Select the **Enable Averaging** checkbox.
  - b. For **Averaging Type**, select **Linear**.
  - c. For **Averaging Mode**, select **RMS**.



## Add FRF Channels to the Plot and Data Config Window

The following steps show how to use the FFT Analyzer interface of QuickDAQ to add two FRF channels to the Plot and Data Config window to calculate the frequency response of analog input channel 0 (DAC) and analog input channel 1 (Acc), and analog input channel 0 (DAC) and analog input channel 2 (MIC).

1. Click the **Add 2 channel FFT function** (  ) button, select **FRF**, and then select **DT9837-A(02).Acc**.  
*The Acc-FRF channel is added to the Plot and Data Config window.*
2. Click the **Add 2 channel FFT function** (  ) button, select **FRF**, and then select **DT9837-A(02).MIC**.  
*The MIC-FRF channel is added to the Plot and Data Config window.*

## Configure the FRF Channels

The following steps show how to use the FFT Analyzer interface of QuickDAQ to configure the parameters used to generate the FRF channels for the analog input channels:

1. Under the **Channel Name** column in the Plot and Data Config window, hold down the **Ctrl** key and select the FRF channels (**Acc-FRF** and **MIC-FRF** in this example) that you want to configure.
2. Click the **Data** tab, and then click the **Function** tab.

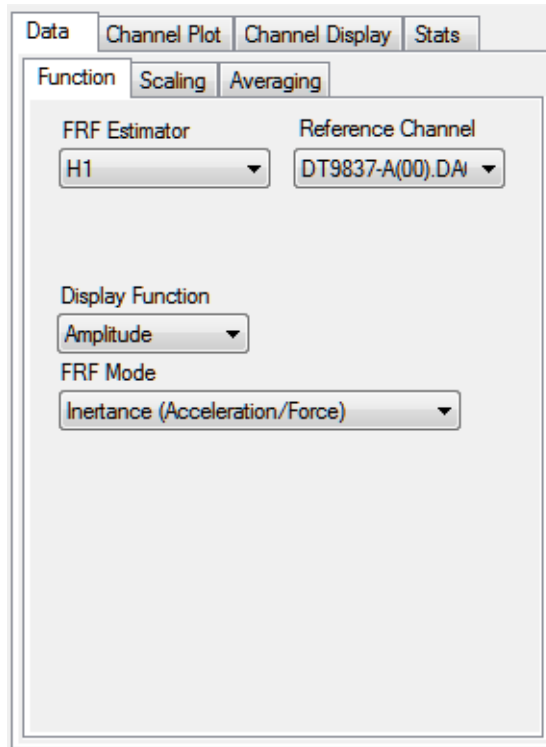

3. For the **Acc-FRF** channel, configure the settings of this tab as follows:
  - a. For **FRF Estimator**, select **H1** (reduces noise on the response channel).
  - b. For **Reference Channel**, select **DAC** (analog input channel 0).
  - c. For **Display Function**, select **Amplitude**.
  - d. For **FRF Mode**, select **Inertance (Acceleration/Force)**.
4. Click the **Scaling** tab, and select **Linear** for **dB/Linear**:

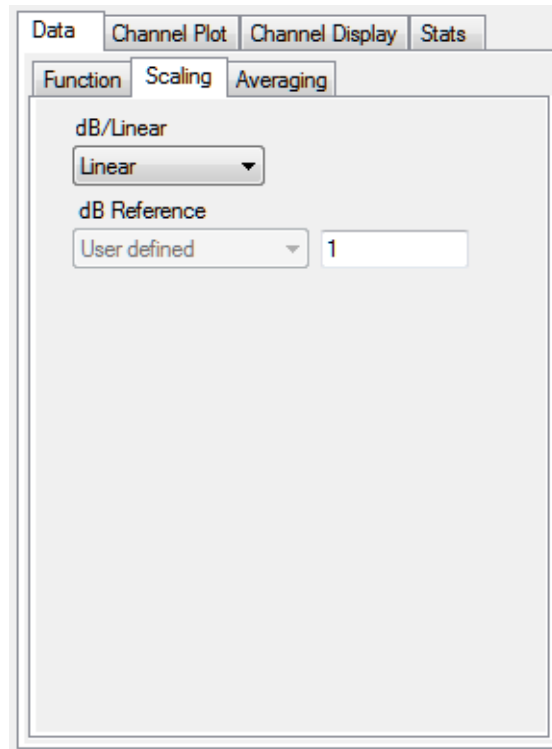

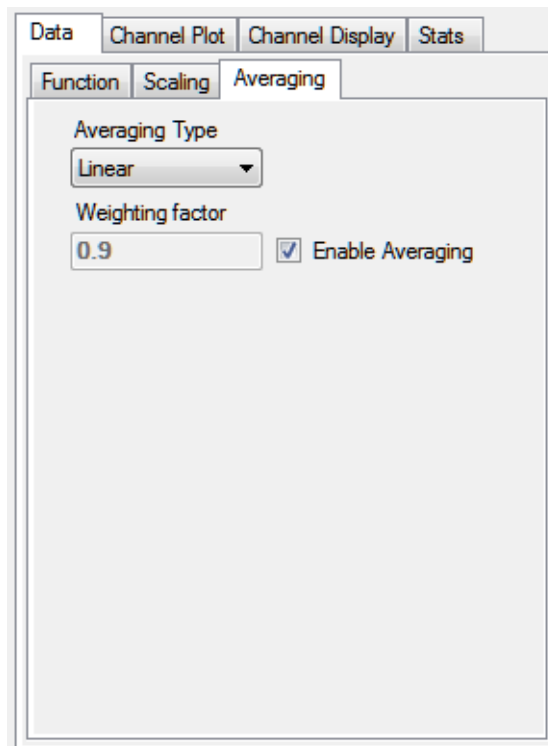

5. Click the **Averaging** tab, select the **Enable Averaging** checkbox, and select **Linear** for **Averaging Type**:





## Add Coherence Channels to the Plot and Data Config Window

The following steps show how to use the FFT Analyzer interface of QuickDAQ to add Coherence channels to the Plot and Data Config window:

1. Click the **Add 2 channel FFT function** (  ) button, select **Coherence**, and select **DT9837-A(02).Acc**.  
*The Acc-Coherence channel is added to the Plot and Data Config window.*
2. Click the **Add 2 channel FFT function** (  ) button, select **Coherence**, and select **DT9837-A(02).MIC**.  
*The MIC-Coherence channel is added to the Plot and Data Config window.*

## Configure the Coherence Channel

The following steps show how to use the FFT Analyzer interface of QuickDAQ to configure the parameters used to generate the Coherence channels for the analog input channels:

1. Under the **Channel Name** column in the Plot and Data Config window, hold down the **Ctrl** key and select the Coherence channels (**Acc-Coherence** and **MIC-Coherence** in this example) that you want to configure.
2. Click the **Data** tab, and then click the **Function** tab.

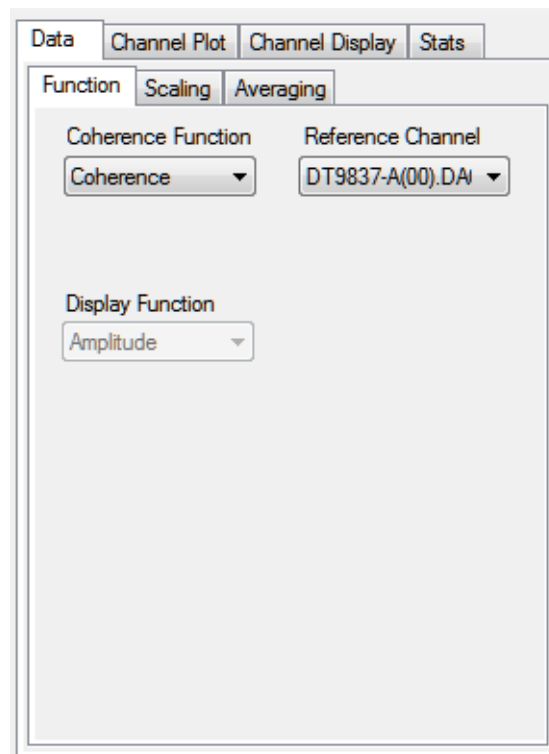

3. For this example, configure the settings of this tab as follows:
  - a. For **Coherence Function**, select **Coherence**.
  - b. For **Reference Channel**, select **DAC** (analog input channel 0).

---

**Note:** **Linear** scaling is selected automatically for Coherence channels under the **Scaling** tab.

---

4. Click the **Averaging** tab, and select **Linear** for **Averaging Type**:

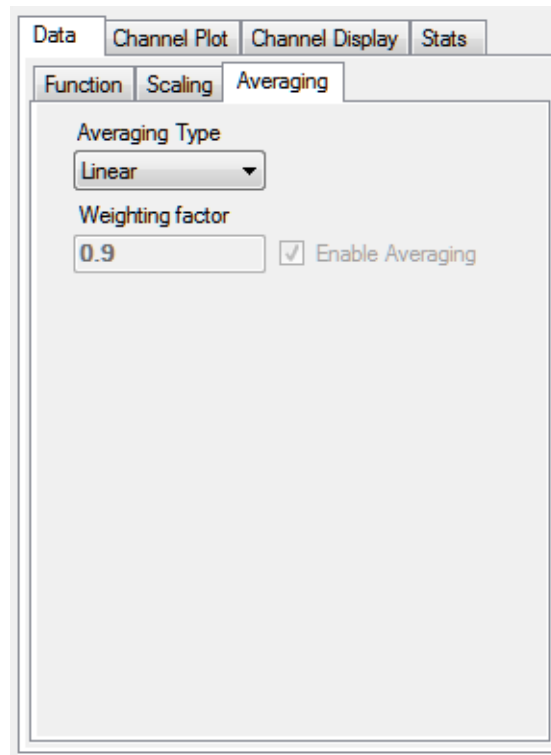

## Configure the Appearance of the Channel Plot Window

Perform the following steps to configure the appearance of the Channel Plot window:

1. Select the **Visible Plot** checkbox for the DAC, DAC-FFT, MIC, MIC-Coherence, MIC-FRF, and MIC-FFT channels.

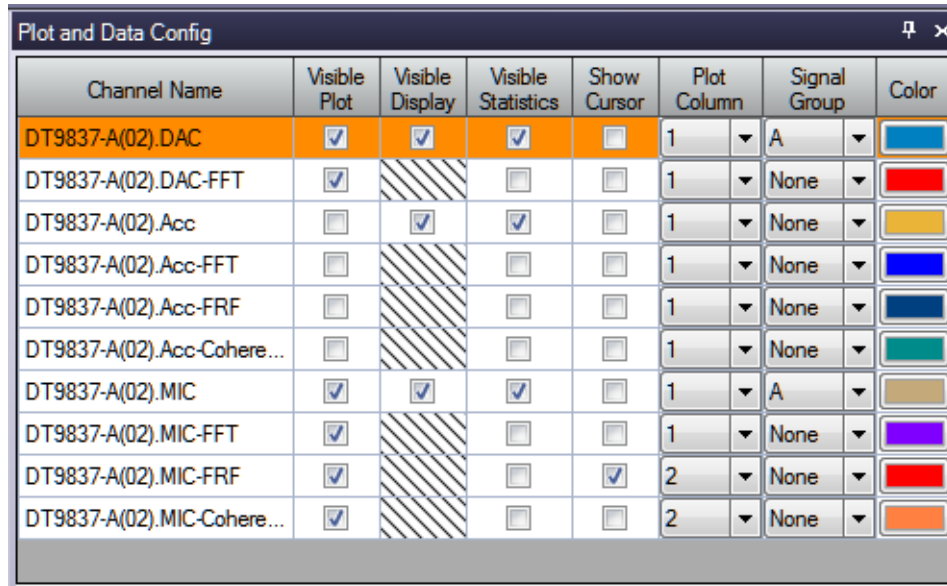

Channel Name	Visible Plot	Visible Display	Visible Statistics	Show Cursor	Plot Column	Signal Group	Color
DT9837-A(02).DAC	<input checked="" type="checkbox"/>	<input checked="" type="checkbox"/>	<input checked="" type="checkbox"/>	<input type="checkbox"/>	1	A	Blue
DT9837-A(02).DAC-FFT	<input checked="" type="checkbox"/>	<input type="checkbox"/>	<input type="checkbox"/>	<input type="checkbox"/>	1	None	Red
DT9837-A(02).Acc	<input type="checkbox"/>	<input checked="" type="checkbox"/>	<input checked="" type="checkbox"/>	<input type="checkbox"/>	1	None	Yellow
DT9837-A(02).Acc-FFT	<input type="checkbox"/>	<input type="checkbox"/>	<input type="checkbox"/>	<input type="checkbox"/>	1	None	Blue
DT9837-A(02).Acc-FRF	<input type="checkbox"/>	<input type="checkbox"/>	<input type="checkbox"/>	<input type="checkbox"/>	1	None	Dark Blue
DT9837-A(02).Acc-Coherence...	<input type="checkbox"/>	<input type="checkbox"/>	<input type="checkbox"/>	<input type="checkbox"/>	1	None	Teal
DT9837-A(02).MIC	<input checked="" type="checkbox"/>	<input checked="" type="checkbox"/>	<input checked="" type="checkbox"/>	<input type="checkbox"/>	1	A	Gold
DT9837-A(02).MIC-FFT	<input checked="" type="checkbox"/>	<input type="checkbox"/>	<input type="checkbox"/>	<input type="checkbox"/>	1	None	Purple
DT9837-A(02).MIC-FRF	<input checked="" type="checkbox"/>	<input type="checkbox"/>	<input type="checkbox"/>	<input checked="" type="checkbox"/>	2	None	Red
DT9837-A(02).MIC-Coherence...	<input checked="" type="checkbox"/>	<input type="checkbox"/>	<input type="checkbox"/>	<input type="checkbox"/>	2	None	Orange

2. Select the **Show Cursor** checkbox for the MIC-FRF channel.
3. Under **Plot Column**, select plot column 1 for the DAC, DAC-FFT, MIC, and MIC-FFT channels, and select plot column 2 for the MIC-Coherence and MIC-FRF channels.
4. Under the **Signal Group** column, select group **A** for the DAC and MIC channels, and leave **None** as the signal group for the rest of the channels.
5. Assign a unique color to each trace for the visible channels, if desired.
6. Click the **Channel Plot - Control** tab.

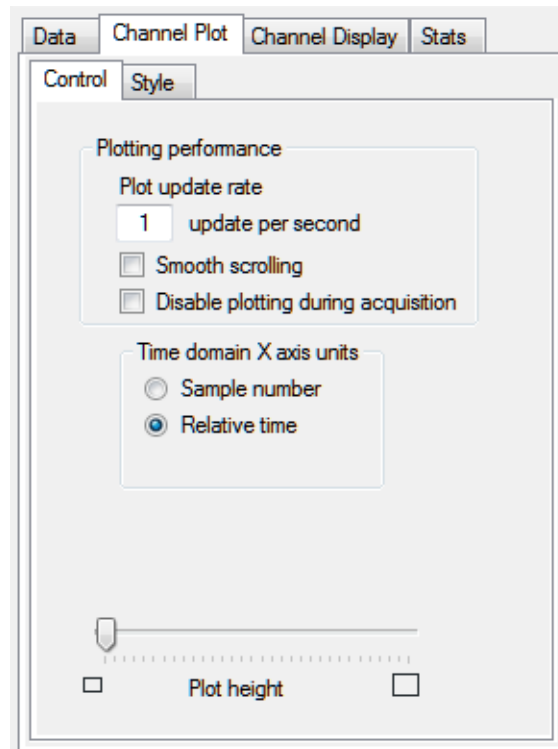

7. Slide the **Plot height** bar to the left until you can see all 5 plots on the Channel Plot window at once.

## Start the Simultaneous Burst Random Output and Analog Input Operation

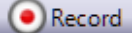
Once you have configured the channels and the parameters for the Channel Plot window, click the **Record** toolbar button (  ) or press the F5 key.

You will hear the waveform three times as it is output from the audio speaker. Results similar to the following are displayed in the Channel Plot window.

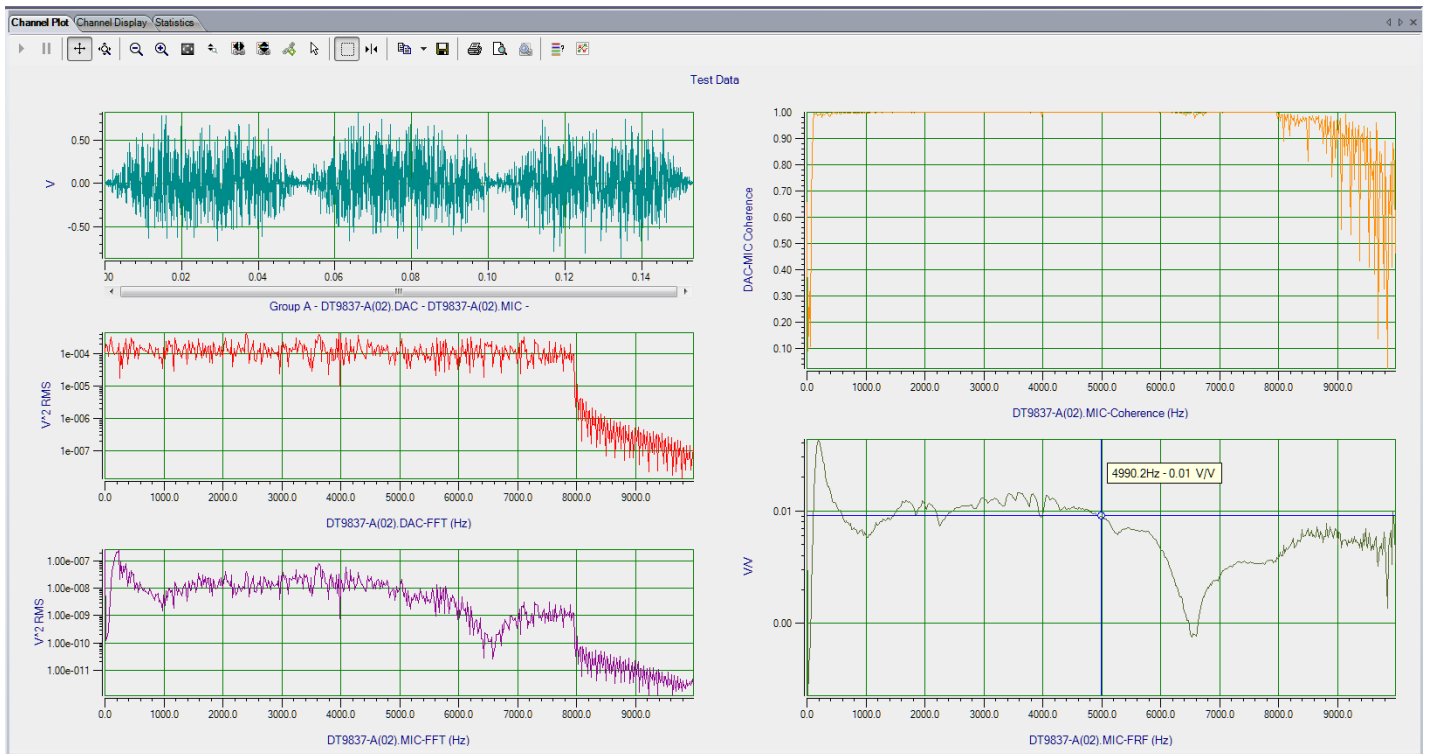

In column 1, you can see the signal that is output from the analog output channel (DAC) and read in as analog input channel 0, and the signal that is measured by the microphone (MIC); this is Group A of the first plot. You can also see the FFT of the analog output channel (DAC) and the FFT of the microphone (MIC).

In column 2, you can see the coherence of the microphone (MIC) and the FRF of the microphone (MIC). In this example, the y-axis of the FRF plot is shown in log10 format (right-click the y-axis, select **Y-Axis Setup...**, and select **Log10** for **Lin/Log**).

---

**Note:** If desired, you can show the data for the Acc, Acc-FFT, Acc-FRF, and Acc-Coherence channels by selecting the **Visible Plot** checkbox in the Channel Plot window.

---

## ***Example of Monitoring an Analog Output Signal***

If you are using the FFT Analysis option or Advanced FFT Analysis option of QuickDAQ, you can use the following steps to monitor the output of an analog output signal on the device using an analog input channel.

In this example, a 3 V sine wave is output on analog output channel 0 of a DT9847-1-1 module. The analog output channel is connected to analog input channel 0 on the DT9847-1-1 module. The FFT Analyzer interface is used.

### **Configure the Analog Output Settings**

For this example, configure the analog output channel as follows:

1. Click the **Output** tab of the Acquisition and Config window.

Recording	Freq	Trigger	Window	Output
Enable	Channel Name	Waveform	Peak Voltage	Offset
<input checked="" type="checkbox"/>	DT9847-1-1(0...	Fixed	3	0

### Waveform

**Signal Type**  
Sine

**Frequency**  
100.00 Hz

**Output Mode**  
Continuous

Repeat burst

### Options

**Burst On Time**  
0.05000 Sec

**Burst Off Time**  
0.001198 Sec

Lock to acquisition time  
 Lock to analysis frame time

**Ramp Up Time**  
0.00000 Sec

**Ramp Down Time**  
0.01000 Sec

### Start/Stop Method

With Acquisition

### Trigger Source

Software

2. Select the **Enable** checkbox to enable the analog output channel on the module.
3. For the **Waveform** type, select **Fixed**.
4. For **Peak Voltage**, enter 3 to output a  $\pm 3$  V signal.

5. For **Offset**, enter 0.
6. For **Signal Type**, select **Sine** to output a sine wave.
7. For **Output Mode**, select **Continuous** to output a waveform that repeats continuously.
8. For **Frequency**, select **100 Hz**; this is the frequency of the output waveform.
9. For **Ramp Up Time**, enter 0.
10. For the **Start/Stop Method**, select **With Acquisition**.  
*The analog output operation will start when you start acquisition.*
11. If desired, hide the Acquisition Config window by clicking the Auto-Hide pin (  ) in the top, right corner of the window.

## Configure the Analog Input Channel

Configure the analog input channel as follows:

1. Ensure that the output from analog output channel 0 is connected to the input of analog input channel 0.
2. Configure the analog input channel by clicking the **Input Channel Configuration** toolbar button (  ) or by clicking the **Configuration** menu and clicking **Input Channel Configuration**.
3. Enable analog input channel 0 by clicking the **Enable** checkbox next to the channel.

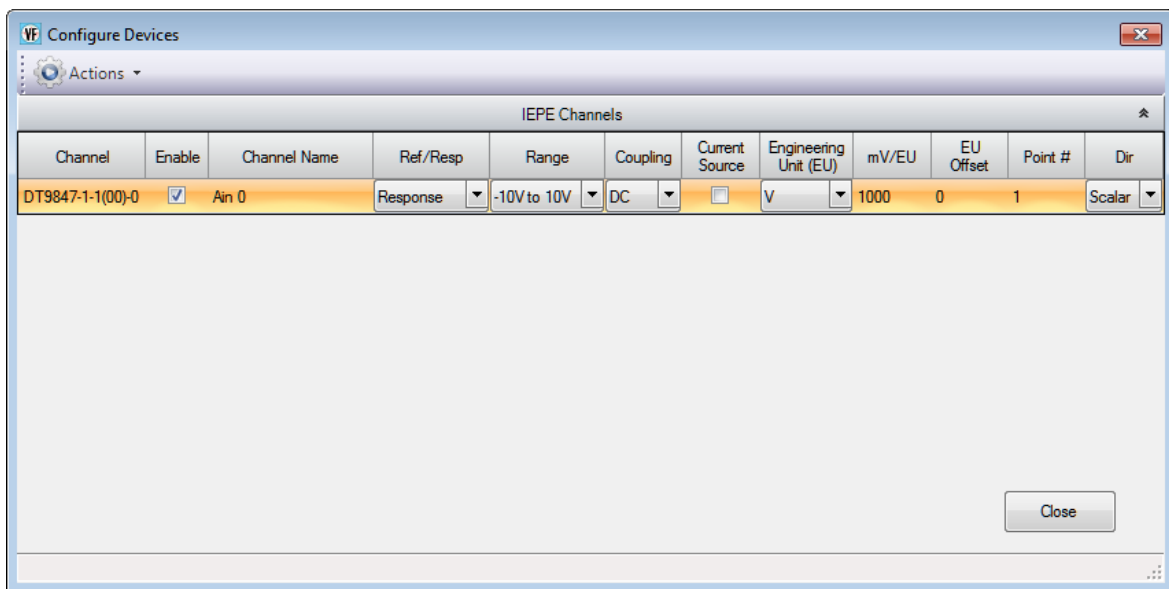

4. Under the **Channel Name** column, leave the default channel name as Ain 0.
5. Under the **Ref/Resp** column, select **Response** for the analog input channel.
6. Under the **Range** column, select the input range for analog input channel.  
*In this example,  $\pm 10$  V is used.*



7. Under the **Coupling** column, select the coupling type (AC or DC) for your sensor.  
*Since this example is monitoring a voltage input, **DC** is used.*
8. Under the **Current Source** column, select whether to enable or disable use of the 4 mA current source on the data acquisition device.  
*Since this example is monitoring a voltage input, the **Current Source** checkbox is not checked (disabled) for the analog input channel.*
9. Under the **Engineering Units** column, select the engineering units for the input.  
*In this example, **V** is used.*
10. Enter the number of mV per engineering unit in the **mV/EU** field.  
*In this example, **1000** is used.*
11. If an offset is specified for the input, enter the value in the **EU Offset** field.  
*In this example, no offset (**0**) is specified.*
12. If desired, enter a test point value for the channel.  
*In this example, **0** is used.*
13. If desired, enter a sensor direction for each channel.  
*In this example, **Scalar** is used.*
14. Click **Close** to close the Configure Devices dialog box.

## Configure the Recording Settings

For this example, configure the recording settings as follows:

1. Click the **Recording** tab of the Acquisition Config window.

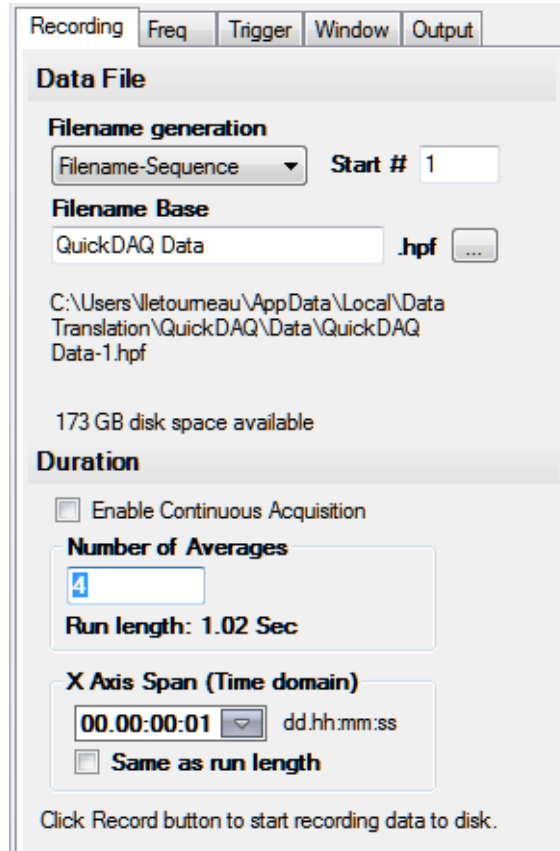

Recording | Freq | Trigger | Window | Output

**Data File**

**Filename generation**  
 Filename-Sequence ▼ Start # 1

**Filename Base**  
 QuickDAQ Data .hpf ...

C:\Users\letoumeau\AppData\Local\Data Translation\QuickDAQ\Data\QuickDAQ Data-1.hpf

173 GB disk space available

**Duration**

Enable Continuous Acquisition

**Number of Averages**  
 4

Run length: 1.02 Sec

**X Axis Span (Time domain)**  
 00:00:00:01 ▼ dd.hh:mm:ss

Same as run length

Click Record button to start recording data to disk.

2. For **Filename generation**, use the **Filename** option.
3. For **Filename**, use the default name for the data file.
4. Leave the **Enable Continuous Acquisition** checkbox unchecked.
5. For **Number of Averages**, enter 4 as the number of records to acquired, process, and average before acquisition stops.  
*The number of seconds for the total run and the amount of available disk space are shown.*
6. Select the span you want to use for the time-domain data on the x-axis.

## Configure the Frequency Settings

For this example, configure the frequency settings as follows:

1. Click the **Freq** tab of the Acquisition Config window.

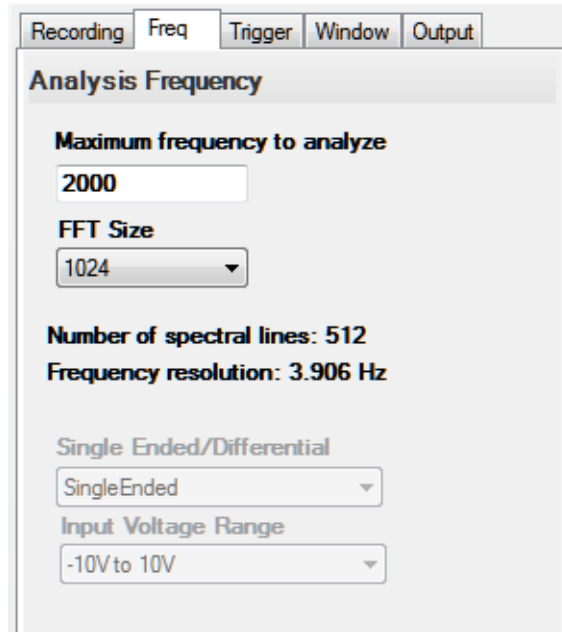

2. In the **Maximum frequency to analyze** text box, enter **2000** as the bandwidth or span, in Hz, of the input signals that you want to analyze  
*Internally, the sampling rate of the data acquisition device is set to twice the bandwidth, or 4000 Hz in this example.*
3. In the **FFT Size** text box, select **1024** from the drop-down combo box as the number of data points to use for the FFT calculation.  
*The number of spectral lines and the frequency resolution are displayed.*

## Configure the Trigger Settings

For this example, configure the trigger settings as follows:

1. Click the **Trigger** tab of the Acquisition Config window.

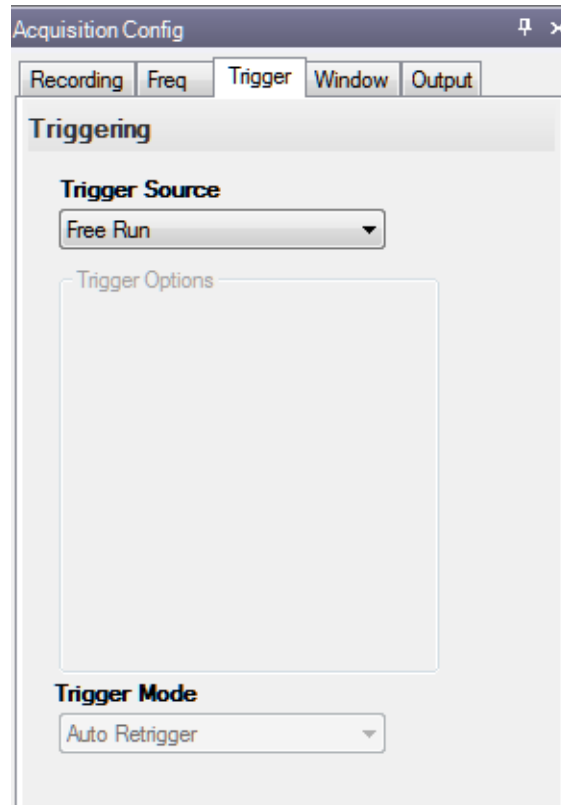



2. For the **Trigger Source**, select **Free Run** to ensure that the measurement starts as soon as the **Record** button is clicked.

## Configure the Windowing Function

For this example, configure the windowing function as follows:

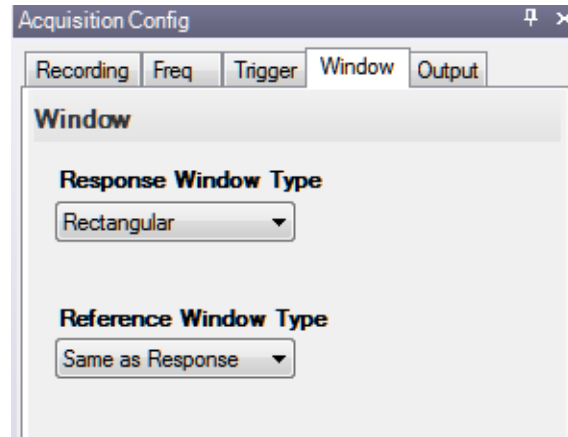
1. Click the **Window** tab of the Acquisition and Config window.  
*The Window tab for the Advanced FFT Analysis option of QuickDAQ is shown. The FFT Analysis option does not use the response and reference window terms and does not support the reference window type.*



2. For the **Response Window Type** (Advanced FFT Analysis option) or **Window Type** (FFT Analysis option), select **Rectangular**.  
*This is a global setting that is applied to the FFTs for all enabled analog input channels.*
3. If you are using the Advanced FFT Analysis option, select **Same As Response** for the **Reference Window Type**.  
*This example does not use reference channels.*
4. If desired, hide the Acquisition Config window by clicking the Auto-Hide pin (  ) in the top, right corner of the window.

## Configure the Appearance of the Statistics Window

In this example, we want to look at the dynamic performance statistics of the analog output signal that is monitored by the analog input channel.

To configure the appearance of the statistics window, perform the following steps:

1. Click the **Statistics** tab and drag it to the lower section of the display area under the Channel Plot window, resizing it as desired:

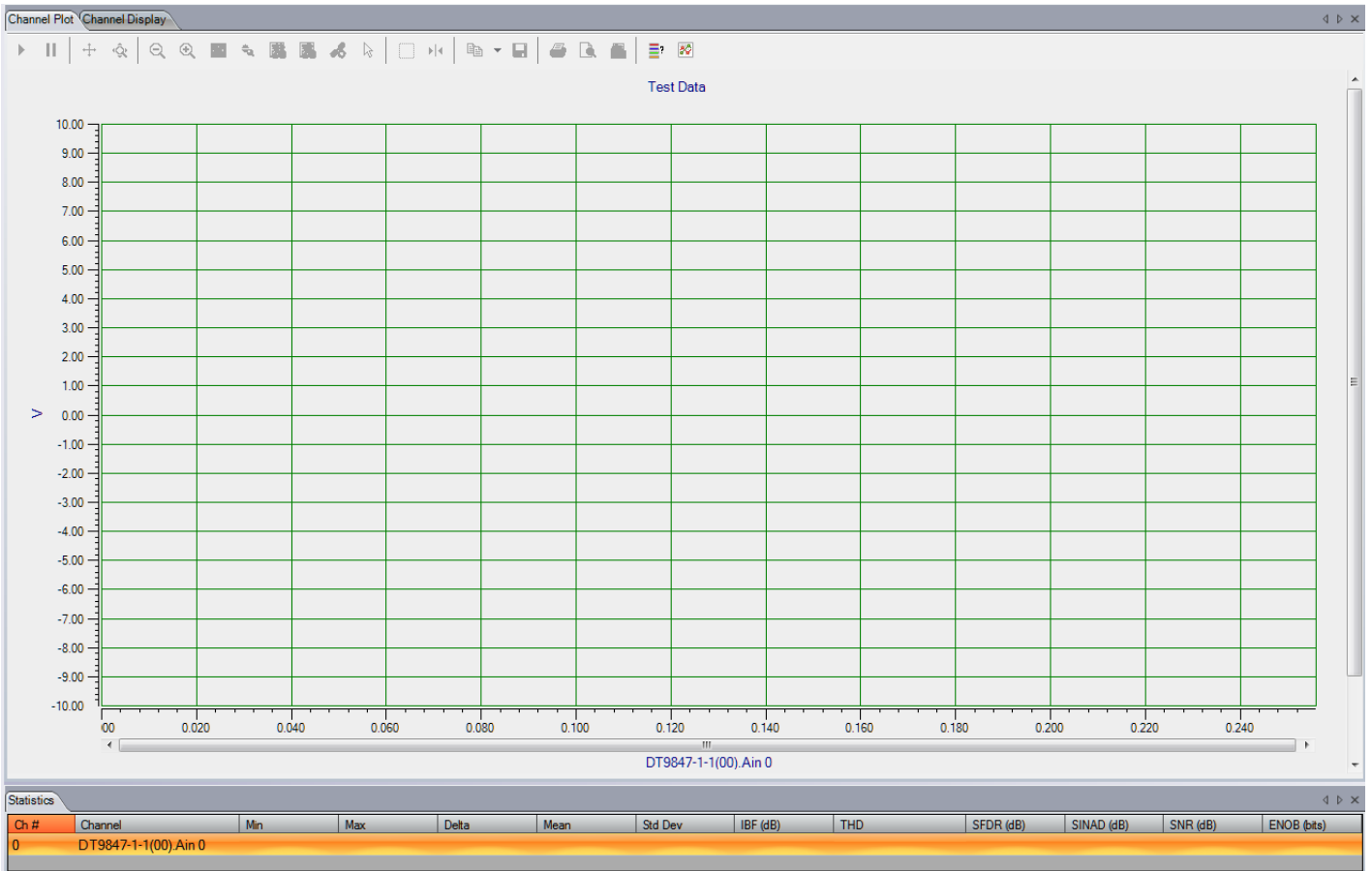

2. In the Plot and Data Config window, check the **Visible Plot** and **Visible Statistics** checkboxes.

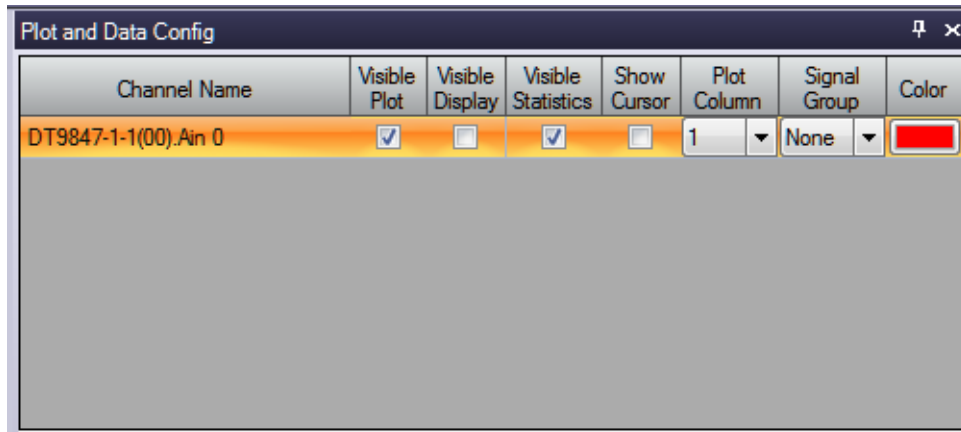

3. Click the Stats tab, and configure it as follows:
  - a. Select the **Show Dynamic Performance Stats** checkbox.
  - b. Select the **Show Min/Max/Mean Stats** checkbox.

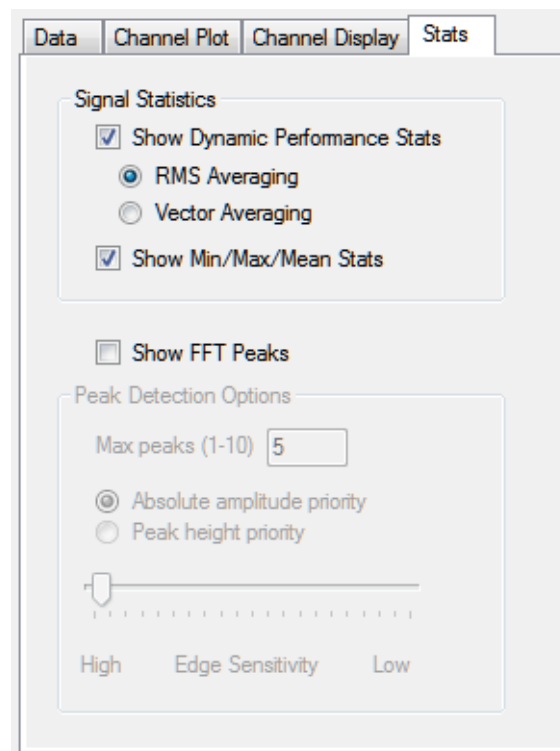

## Start the Operation

Once you have configured the channels and the application parameters, click the **Record** toolbar button (  ) or press the **F5** key to start the operation.

Results similar to the following are displayed in the Channel Plot window, showing the output of analog output channel 0 as measured by analog input channel 0, and the statistics for the channel.

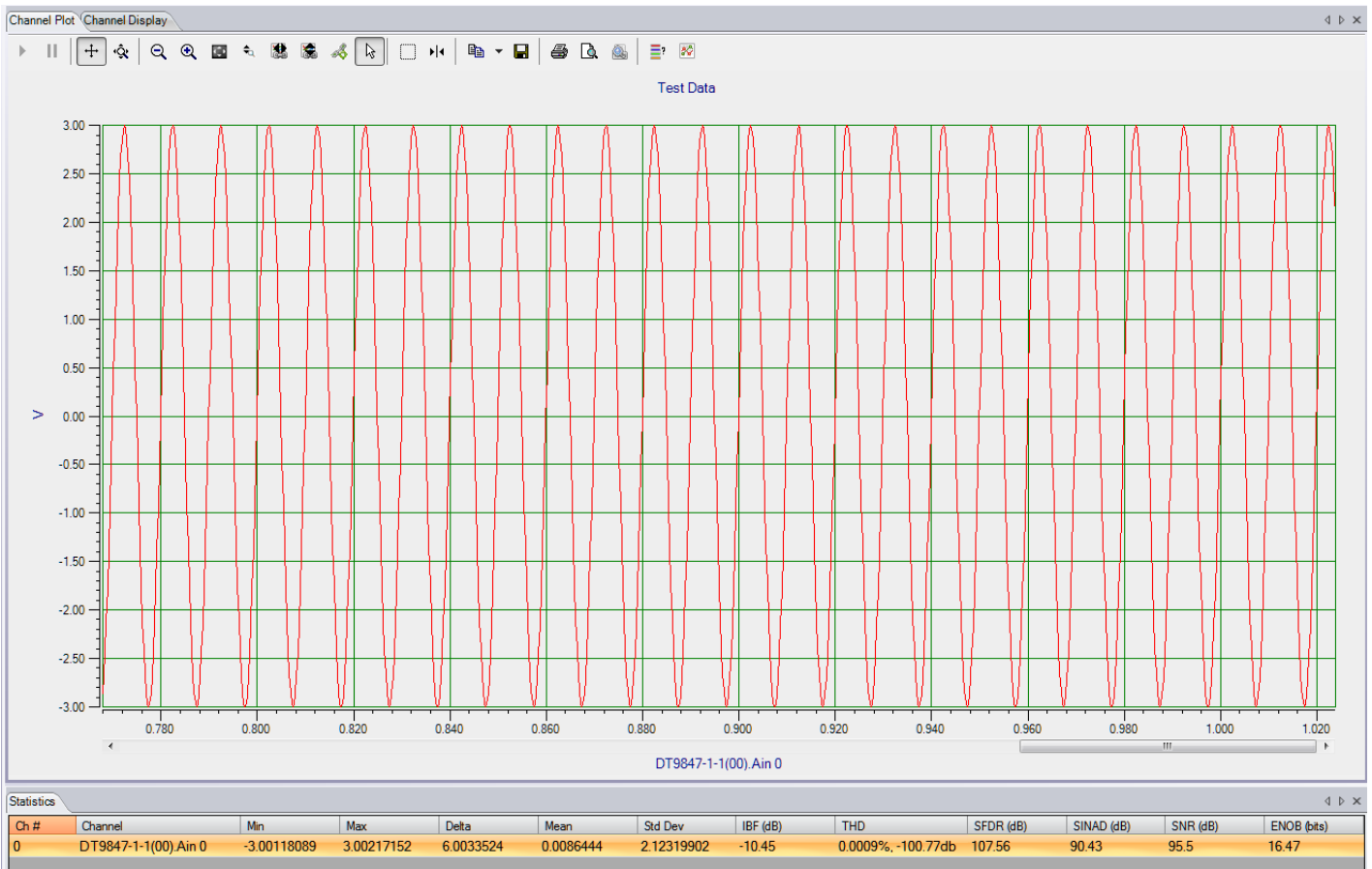



## Example of Using a Digital Filter

This example shows how to use a low-pass digital filter to eliminate unwanted high-frequency signals from your data.

In this example, a function generator, which is generating a 1 kHz output signal with an amplitude of approximately 6 V, is attached to analog input 0 of a DT9837A module.

### Configure the Input Channel

To configure the input channel, perform the following steps:

1. Click the **Input Channel Configuration** toolbar button (  ) or click the **Configuration** menu and click **Input Channel Configuration**.
2. Enable analog input channel 0 by clicking the **Enable** checkbox for this channel.

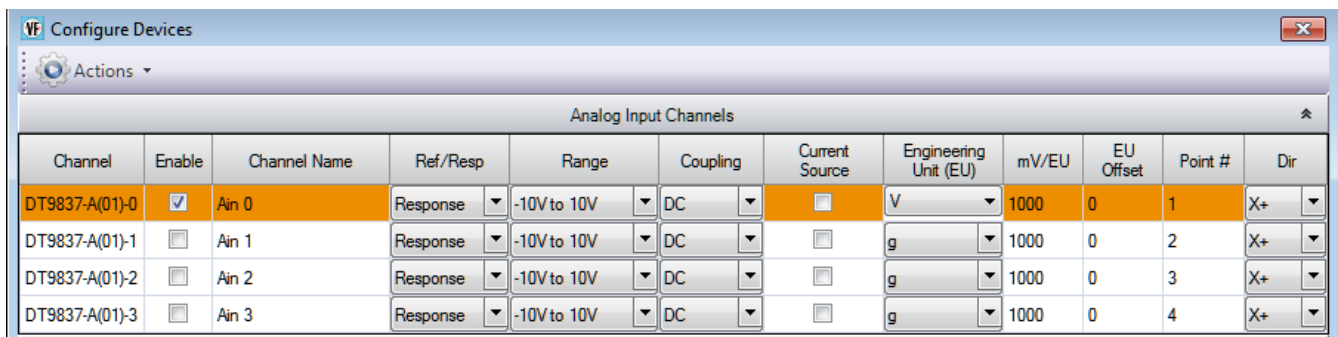

Channel	Enable	Channel Name	Ref/Resp	Range	Coupling	Current Source	Engineering Unit (EU)	mV/EU	EU Offset	Point #	Dir
DT9837-A(01)-0	<input checked="" type="checkbox"/>	Ain 0	Response	-10V to 10V	DC	<input type="checkbox"/>	V	1000	0	1	X+
DT9837-A(01)-1	<input type="checkbox"/>	Ain 1	Response	-10V to 10V	DC	<input type="checkbox"/>	g	1000	0	2	X+
DT9837-A(01)-2	<input type="checkbox"/>	Ain 2	Response	-10V to 10V	DC	<input type="checkbox"/>	g	1000	0	3	X+
DT9837-A(01)-3	<input type="checkbox"/>	Ain 3	Response	-10V to 10V	DC	<input type="checkbox"/>	g	1000	0	4	X+

3. Under the **Range** column, select the an input range of  $\pm 10$  V for the signal.
4. Under the **Engineering Unit (EU)** column, select **V** for voltage.
5. Leave the remainder of the settings at their default values.
6. Click **Close**.

## Configure the Recording Settings

For this example, configure the recording settings as follows:

1. Click the **Recording** tab of the Acquisition Config window.

The screenshot shows the 'Recording' tab of the Acquisition Config window. It features several sections for configuring data file settings and acquisition parameters.

- Data File**
  - Filename generation:** A dropdown menu is set to 'Filename-Sequence' and a 'Start #' field is set to '1'.
  - Filename Base:** A text field contains 'QuickDAQ Data' followed by a '.hpf' extension and a browse button ('...').
  - The full file path is displayed as: C:\Users\Nletoumeau\AppData\Local\Data Translation\QuickDAQ\Data\QuickDAQ Data-1.hpf
  - A status message indicates '173 GB disk space available'.
- Duration**
  - The 'Enable Continuous Acquisition' checkbox is checked.
  - The 'Number of Averages' is set to '50', resulting in a 'Run length: 12.8 Sec'.
  - The 'X Axis Span (Time domain)' is set to '00:00:00:01' in 'dd.hh:mm:ss' format.
  - The 'Same as run length' checkbox is unchecked.

At the bottom, a note states: 'Click Record button to start recording data to disk.'

2. For **Filename generation**, use the **Filename-Sequence** option.
3. For **Filename**, use the default name for the data file.
4. Check the **Enable Continuous Acquisition** checkbox.
5. Select the span you want to use for the time-domain data on the x-axis.

## Configure the Frequency Settings

Configure the frequency settings as follows:

1. Click the **Freq** tab of the Acquisition Config window.

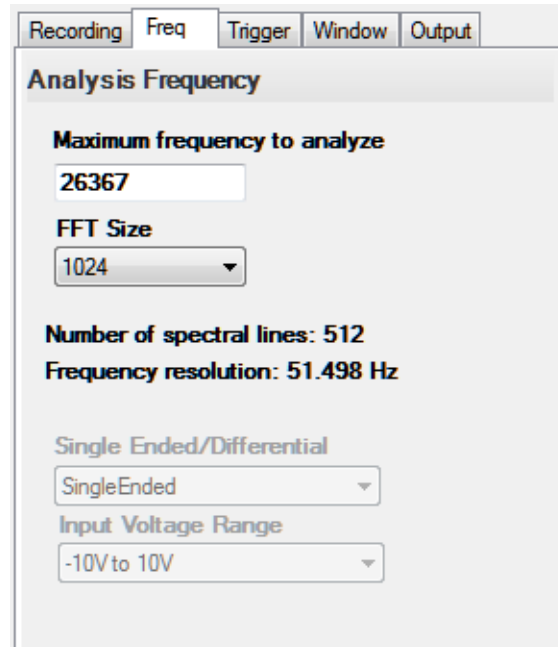

The screenshot shows the 'Analysis Frequency' configuration window in the FFT Analyzer interface. The window has a tabbed interface with 'Recording', 'Freq', 'Trigger', 'Window', and 'Output' tabs. The 'Freq' tab is selected. The window contains the following settings:

- Maximum frequency to analyze:** 26367
- FFT Size:** 1024
- Number of spectral lines:** 512
- Frequency resolution:** 51.498 Hz
- Single Ended/Differential:** SingleEnded
- Input Voltage Range:** -10V to 10V

2. In the **Maximum frequency to analyze** text box, enter **26367** as the bandwidth or span, in Hz, of the input signals that you want to analyze  
*Internally, the sampling rate of the data acquisition device is set to twice the bandwidth, or the maximum rate of the module (52734 Hz) in this example.*
3. In the **FFT Size** text box, select **1024** from the drop-down combo box as the number of data points to use for the FFT calculation.  
*The number of spectral lines and the frequency resolution are displayed.*

## Configure the Trigger Settings

For this example, configure the trigger settings as follows:

1. Click the **Trigger** tab of the Acquisition Config window.

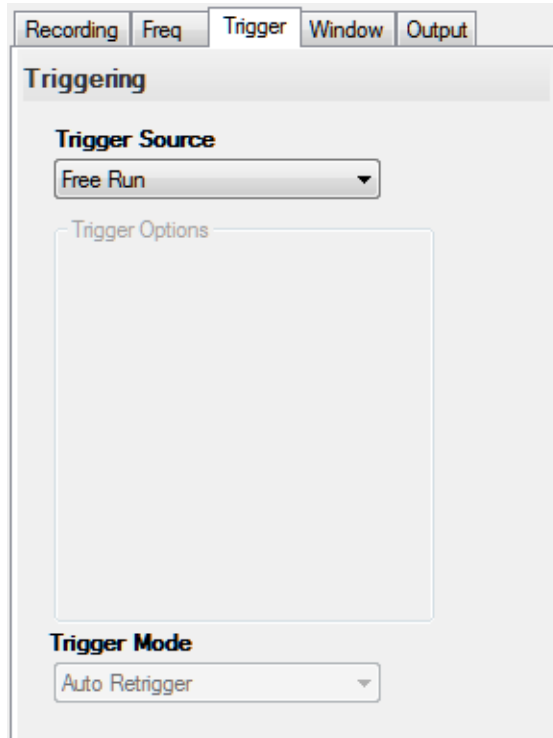

2. For the **Trigger Source**, select **Free Run** to ensure that the measurement starts as soon as the **Record** button is clicked.  
*In this mode, the Trigger Mode is not used.*

## Open the Digital Filter Configuration Dialog

For this example, open the Digital Filter Configuration dialog by clicking the **Digital Filter Configuration** toolbar button (  ) or by clicking the **Configuration** menu and clicking **Digital Filter Configuration**.

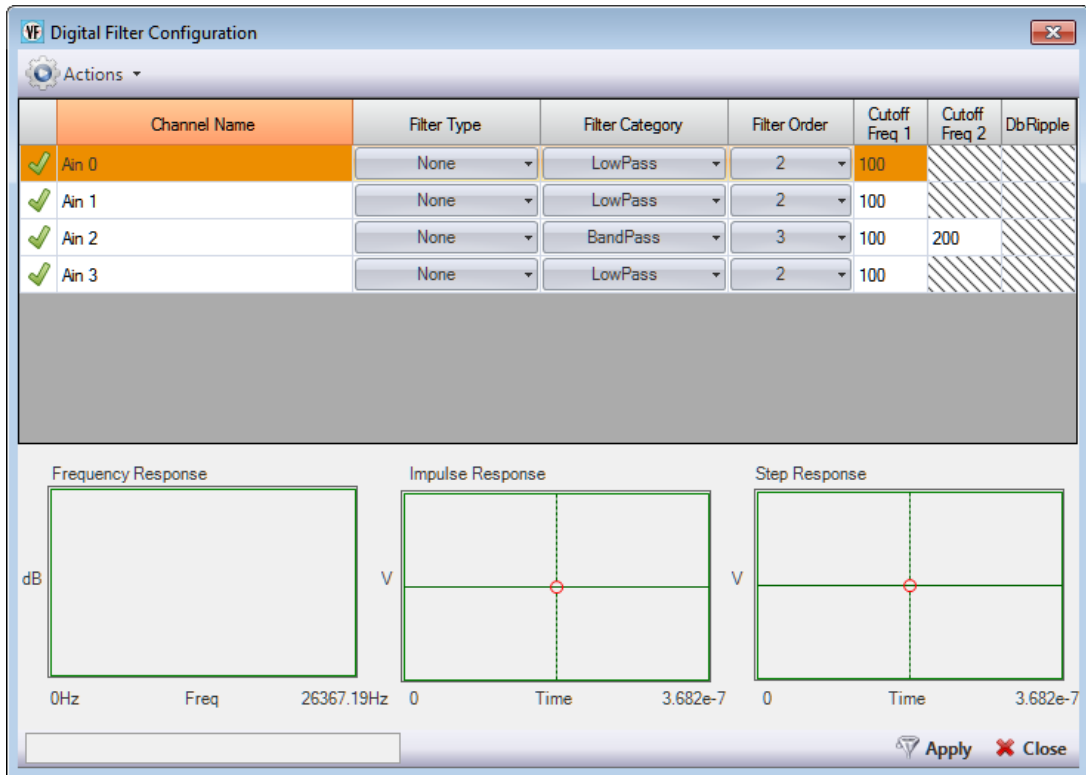

	Channel Name	Filter Type	Filter Category	Filter Order	Cutoff Freq 1	Cutoff Freq 2	Db Ripple
✓	Ain 0	None	LowPass	2	100		
✓	Ain 1	None	LowPass	2	100		
✓	Ain 2	None	BandPass	3	100	200	
✓	Ain 3	None	LowPass	2	100		

Frequency Response: dB vs Freq (0Hz to 26367.19Hz)

Impulse Response: V vs Time (0 to 3.682e-7)

Step Response: V vs Time (0 to 3.682e-7)

Apply Close

For now, leave the default settings for analog input channel 0, so that no digital filter is applied.

Leave this dialog open.

## Start the Acquisition

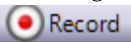
Once you have configured analog input channel 0 and the application parameters, click the **Record** toolbar button (  ) or press the **F5** key to start the operation.

Results similar to the following are displayed in the Channel Plot window, showing the unfiltered 1 kHz signal that is generated by the function generator.

Let acquisition continue to run, and go to the next step.

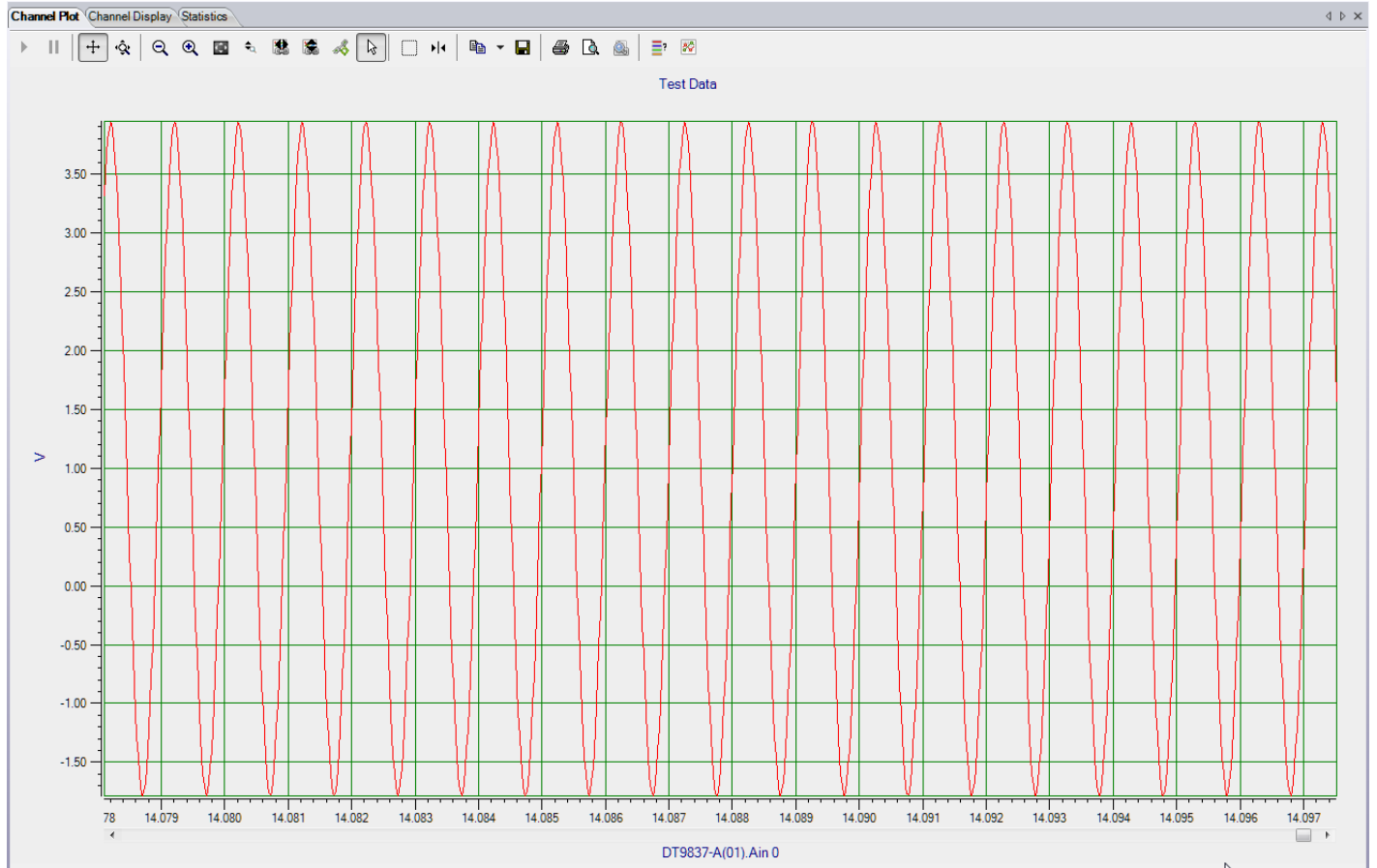

**Figure 43: Unfiltered 1 kHz Signal**

## Configure the Digital Filter Configuration Dialog

While acquisition is running, change the settings in the Digital Filter Configuration dialog to configure a Bessel low-pass filter for analog input channel 0.

Channel Name	Filter Type	Filter Category	Filter Order	Cutoff Freq 1	Cutoff Freq 2	DbRipple
Ain 0	Bessel	LowPass	4	500		
Ain 1	None	LowPass	2	100		
Ain 2	None	BandPass	3	100	200	
Ain 3	None	LowPass	2	100		

Configure the filter as follows:

1. Under the **Filter Type** column, select **Bessel**.
2. Under the **Filter Category** column, select **LowPass**.
3. Under the **Filter Order** column, select **4**.
4. Under the **Cutoff Freq 1** column, enter **500**. This is the frequency above which the signals will be attenuated.
5. Click **Apply**.

The attenuated signal is displayed. In this example, a low-pass filter is used so that all frequencies above 500 Hz are attenuated.

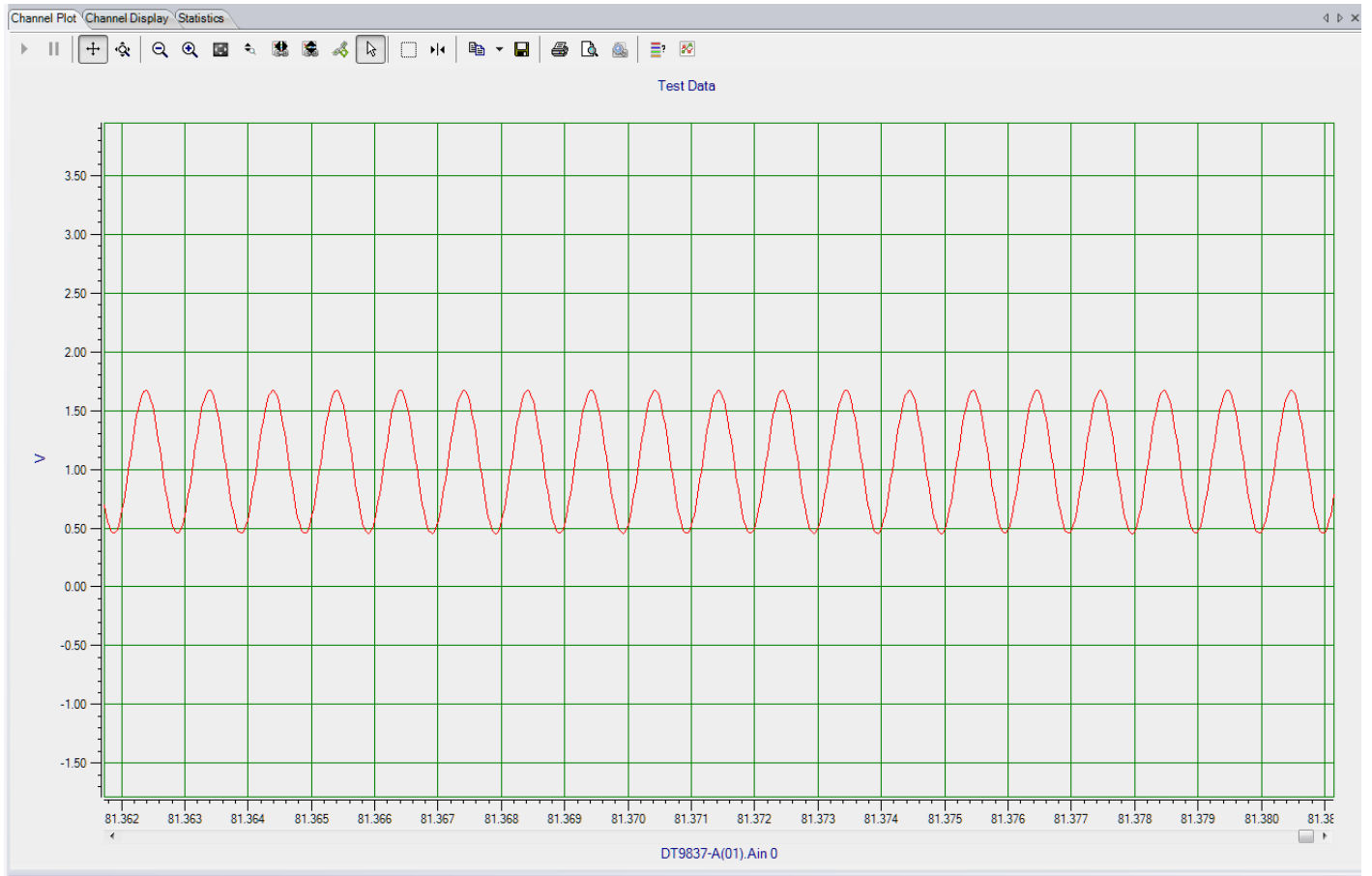

**Figure 44: Attenuated 1 kHz Signal Using a Bessel Low-Pass Filter (500 Hz Cutoff Frequency)**





## ***Support***

Troubleshooting .....	386
Technical Support.....	387

## Troubleshooting

If you are performing an acquisition for a long duration, you may see that acquisition stops if your computer's power options are not set correctly. If this problem occurs, do the following to change the power options of your computer:

1. Go to the Control Panel application for your computer.
2. Select **Power Options**.
3. For the **Put the Computer to Sleep** option, select **Never**.

Should you experience other problems using QuickDAQ, do the following:

1. Read all the appropriate sections of this manual, including any "Read This First" information.
2. Check for a README file on the CD. If present, read this file for the latest installation and usage information.
3. Check that you have installed your data acquisition devices properly. For information, refer to the documentation supplied with your devices.
4. Check that you have installed the latest device drivers for your data acquisition devices. For information, refer to the documentation supplied with your devices.
5. Check that you have installed your software properly. For information, refer to [page 26](#)
6. Search the Data Translation web site ([www.mccdaq.com](http://www.mccdaq.com)) for information about QuickDAQ.
7. Search the Knowledgebase in the Support section of the Data Translation web site (at [www.mccdaq.com](http://www.mccdaq.com)) for an answer to your problem.

If you are still having problems, Data Translation's Technical Support Department is available to provide technical assistance to licensed users.

---

## Technical Support

If you have any difficulty using QuickDAQ, Data Translation's Technical Support Department is available to provide technical assistance.

To request technical support, go to our web site at <http://www.mccdaq.com> and click on the **Support** link.

---

**Note:** Any unhandled exceptions that occur when running QuickDAQ are captured and displayed in a dialog box; these exceptions are also appended to a file called QuickDAQErrLog.log off the root directory (C:\QuickDAQErrLog.log). If you receive an unhandled exception, please email the QuickDAQErrLog.log file to the Data Translation Technical Support Department at [info@mccdaq.com](mailto:info@mccdaq.com).

---

When requesting technical support, be prepared to provide the following information:

- The version of QuickDAQ that you are using
- The serial number of your data acquisition device



# Glossary

## Absolute Amplitude of Peak

The largest peak measured from the reference value to the top of the peak. An example follows:

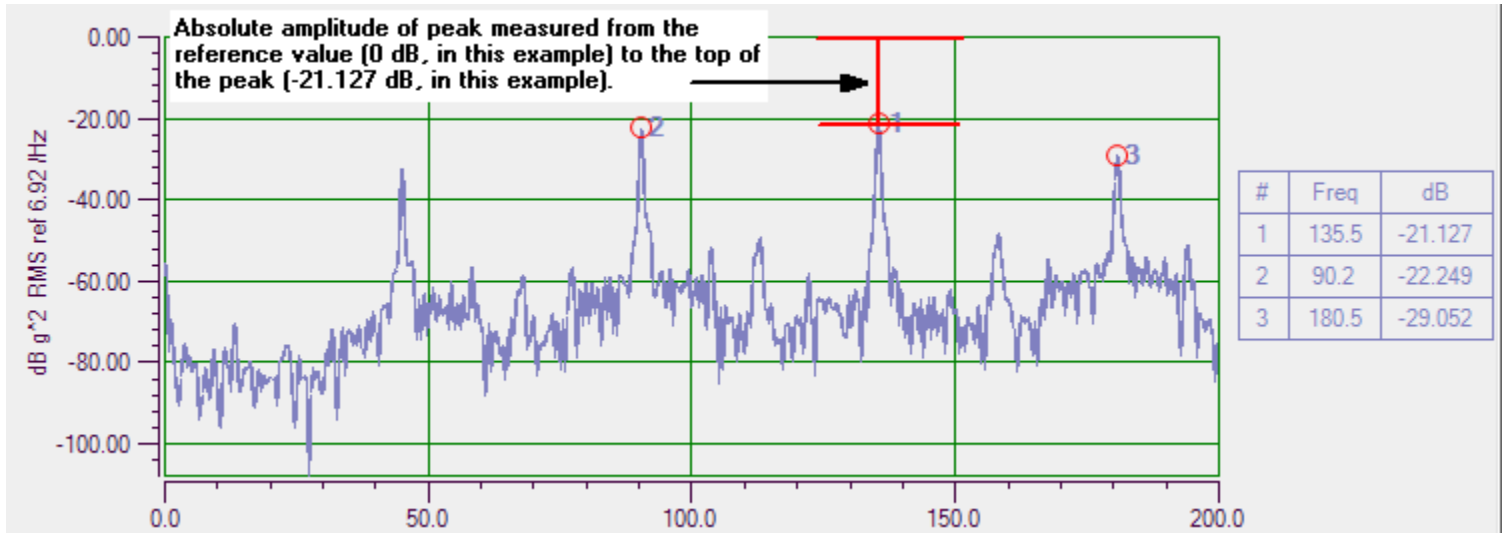

## Accelerometer

A type of sensor that produces an output voltage that is proportional to acceleration.

## Acquisition

Data from a specified list of analog input, tachometer, and/or counter channels is collected by a data acquisition device at a specified rate.

## Amplitude Display Function

Plots the length of the frequency response.

## Apparent Mass

An FRF mode that is calculated as the Force of the Reference Channel/ Acceleration of the Response Channel. It is the reciprocal function of Inertance.

## Auto Spectrum

A single-channel display function that plots the power of a periodic frequency component at a discrete frequency. For an accelerometer, for example, the units for **Auto Spectrum** are represented as  $g^2$ . Typically, **Auto Spectrum** is best for narrowband, deterministic signals.

## Average

A series of measurements that are combined to create a result. The results from the last completed measurement are combined, point by point, with the results from the previous measurement. The combined results are retained and displayed as they are updated.

## Bartlett Window

Triangular window.

**Blackman Window**

Similar to the Hanning and Hamming windows, this window has slightly wider central lobes and less sideband leakage.

**Blackman Harris Window**

Similar to Hanning window, this window has a slightly wider main lobe but much better dynamic range. It is optimized to provide the minimum side lobe level.

**dB**

Decibels. The decibel scale is a transformation of the linear scale into a logarithmic scale. A decibel is defined as follows:

$$\text{dB} = 20 * \log_{10} (\text{Voltage}/\text{RefVolt})$$

where *RefVolt* is the dB Reference value.

**dB Reference**

The reference value (*RefVolt*) that is used when computing values into the decibel scale:

$$\text{dB} = 20 * \log_{10} (\text{Voltage}/\text{RefVolt})$$

*dB Reference* is expressed in the selected engineering units, such a *V* for voltage.

**Channel**

In QuickDAQ, a channel is either a single input of a data acquisition device that is sampled periodically to generate data, the resultant FFT on the data from an input channel, or the result of an FRF, coherence, or cross spectrum function on the data from an input channel.

**Chirp**

A signal in which the frequency increases (sometimes called an up-chirp) or decreases (sometimes called a down-chirp) with time.

**Coherence Function**

A two-channel display function that evaluates the linearity between the input (reference) signal and the output (response) signal at each frequency, and generates a value between 0.0 and 1.0, where 0 is consistently not linear and 1.0 is consistently linear.

**Compliance**

An FRF mode that is calculated as the Displacement of the Response Channel/Force of the Reference Channel.

**Cosine Taper**

This window allows you to specify the percentage of the period to allow the signal to come through unaltered before smoothing the signal ends to zero.

**Cross Spectrum Function**

A two-channel display function of the frequency domain. It contains a building block that is used in FRF and other more advanced functions. It is the product of the complex Fourier spectrum of the response channel multiplied by the complex conjugate of the Fourier spectrum of the reference channel.

---

### **Dynamic Stiffness**

An FRF mode that is calculated as the Force of the Reference Channel/Displacement of the Response Channel.

### **Double Integration**

Double integration results in displacement (the engineering units change and are denoted with “~~”).

### **ENOB**

Effective Number of Bits, returned in bits, represents the quality of a digitized signal. The input signal is typically sinusoidal and should be near full-scale to properly characterize the A/D converter and/or system. Refer to [page 246](#) for more information.

### **EU**

Engineering Unit.

### **Exponential Averaging**

With exponential averaging, new FFT data is weighted differently than older FFT data.

You specify the weighting factor to apply, which either increases or decreases the effect of the new FFT data on the average. This is a continuous averaging mode.

### **Exponential Window**

Typically applied to the response channel in impact testing applications, this window is equal to 1.0 at the beginning of the record and decays exponentially to a smaller value at the end of the record. You can specify a value between 0 and 1 as the *Exp Factor*. This value indicates how much to decay the signal, allowing you to tailor the resultant FFT to the relevant data in the record.

### **FFT**

Fast Fourier Transform (FFT). A technique for calculating the frequency components in a time-domain waveform based on digitized voltage measurements. The result is a display of amplitude versus frequency and phase versus frequency.

### **FFT Window Type**

FFT windows are frequency weighting functions that are applied to the time domain data. An FFT window is typically applied to reduce spectral leakage errors that are associated with finite-duration time signals.

By multiplying each data frame by a suitable time-domain weighting window, an FFT window smooths the data, creating peaks in the middle frequencies and decreasing to zero at the edges.

The following table provides general information about each window type to help you choose which to use:

**Table 3: FFT Window Types**

Window	Description
Rectangular	No window. Recommended for use when your signal content contains random noise (white noise) or closely spaced sine waves.
Hanning	Bell-shaped cosine window typically used to analyze continuous signals. Recommended for use when your signal content contains sine waves, a combination of sine waves, vibration data consisting of narrowband random signals, or unknown content.
Hamming	Bell-shaped cosine window optimized to minimize the maximum (nearest) side lobe. Recommended for use when your signal content consists of closely spaced sine waves.
Bartlett	Triangular window.
Blackman	Similar to the Hanning and Hamming windows, this window has slightly wider central lobes and less sideband leakage.
Blackman Harris	Similar to Hanning window, this window has a slightly wider main lobe but much better dynamic range. It is optimized to provide the minimum side lobe level.
Flat Top	Optimized for measuring peak amplitudes of discrete spectral components that are separated by several spectral lines. Recommended for use when your signal content consists of sine waves and amplitude accuracy is important.
Exponential	Typically applied to the response channel in impact testing applications, this window is equal to 1.0 at the beginning of the record and decays exponentially to a smaller value at the end of the record. You can specify a value between 0 and 1 as the <i>Exp Factor</i> . This value indicates how much to decay the signal, allowing you to tailor the resultant FFT to the relevant data in the record.
Cosine Taper	This window allows you to specify the percentage of the period to allow the signal to come through unaltered before smoothing the signal ends to zero.
Force	<p>Typically applied to the reference window in impact testing applications, allows you to specify the percentage of the signal period to which the rectangular window is applied. Data outside the selected percentage is forced to zero.</p> <p>You can enter the percentage of the period at which the rectangular window starts, as well as the percentage of the signal period at which the rectangular window stops.</p> <p>By applying this window to the output of a transducer, you can avoid collecting extraneous signals, such as forces from the retraction of a hammer, that are not important to the measurement.</p>

**Flat Top Window**

Optimized for measuring peak amplitudes of discrete spectral components that are separated by several spectral lines. Recommended for use when your signal content consists of sine waves and amplitude accuracy is important.

**Force Window**

Typically applied to the reference window in impact testing applications, allows you to specify the percentage of the signal period to which the rectangular window is applied. Data outside the selected percentage is forced to zero.

You can enter the percentage of the period at which the rectangular window starts, as well as the percentage of the signal period at which the rectangular window stops.



---

By applying this window to the output of a transducer, you can avoid collecting extraneous signals, such as forces from the retraction of a hammer, that are not important to the measurement.

### Frequency Domain

When plotted, amplitudes are graphed in relation to frequency. Also see *Time Domain*.

### FRF (Frequency Response Function)

A two-channel function that represents the complex ratio between the output (response) signal and the input (reference) signal as a function of frequency. By choosing a FRF estimator, you can determine how the FRF is calculated.

### FRF Estimator

The **FRF Estimator** determines how the frequency response is calculated. You can choose one of the following settings for **FRF Estimator**:

- **H1** – Reduces noise on the response channel. It is calculated as follows:

$$H_1 = S_{xf}/S_{ff}$$

where,

$S_{xf}$  represents the average cross power spectrum between the response and the reference signals.

$S_{ff}$  represents the average auto power spectrum of the reference signal.

- **H2** – Reduces noise on the reference channel. It is calculated as follows:

$$H_2 = S_{xx}/S_{fx}$$

where,

$S_{xx}$  represents the average auto spectrum of the response signal.

$S_{fx}$  represents the average cross power spectrum between the response and the reference signals.

- **H3** – Reduces noise on both the reference and response channels. H3 is computed as follows:

$$H_3 = (H_1 + H_2)/2$$

### g

Acceleration in relation to earth's gravity, where  $1g = 980 \text{ cm/s}^2$  or  $32.2 \text{ ft/s}^2$ .

### Gain

The factor by which to amplify a signal to allow greater resolution.

### Hamming Window

Bell-shaped cosine window optimized to minimize the maximum (nearest) side lobe. Recommended for use when your signal content consists of closely spaced sine waves

### Hanning Window

Bell-shaped cosine window typically used to analyze continuous signals. Recommended for use when your signal content contains sine waves, a combination of sine waves, vibration data consisting of narrowband random signals, or unknown content.

**H1**

This FRF Estimator mode reduces noise on the response channel. It is calculated as follows:

It is calculated as follows:

$$H_1 = S_{xf}/S_{ff}$$

where,

$S_{xf}$  represents the average cross power spectrum between the response and the reference signals.

$S_{ff}$  represents the average auto power spectrum of the reference signal.

**H2**

This FRF Estimator mode reduces noise on the reference channel. It is calculated as follows:

$$H_2 = S_{xx}/S_{fx}$$

where,

$S_{xx}$  represents the average auto spectrum of the response signal.

$S_{fx}$  represents the average cross power spectrum between the response and the reference signals.

**H3**

This FRF Estimator mode reduces noise on both the reference and response channels. H3 is computed as follows:

$$H_3 = (H_1 + H_2)/2$$

**IBF**

Input below full-scale, in dB, represents the level of the main signal component relative to the full-scale voltage. Refer to [page 239](#) for more information.

**Inertance**

An FRF mode that is calculated as the Acceleration of the Response Channel/Force of the Reference Channel.

**Impedance**

An FRF mode that is calculated as the Force of the Reference Channel/Velocity of the Response Channel.

**Integration**

Integration is calculated by dividing each element of the function by  $(jw)^n$ , where  $j$  is the square root of  $-1$ ;  $w$  is the product of  $2\pi$  times the frequency of the block element; and  $n$  is an integer from  $+2$  to  $-2$ .

If you specify an accelerometer as the sensor type, single integration results in velocity (the engineering units change and are denoted with “~”), and double integration results in displacement (the engineering units change and are denoted with “~~”).

### Linear

Data in the FFT is plotted in the engineering units of the specified signal, such as  $V$  for voltage or  $g$  for acceleration.

### Linear Averaging

Data from each FFT is averaged with the data from the other FFTs; all data contributes equally to the average.

### Magnitude

The FFT of a real signal is a complex number, having a real and an imaginary part. The magnitude is the square root of the sum of the squares of the real and imaginary parts.

### Mobility

An FRF mode that is calculated as the Velocity of the Response Channel/Force of the Reference Channel.

### Nyquist Display Function

This display function plots the resultant data in complex form, with real components on the x-axis and imaginary components on the y-axis. It used to assess the stability and performance of a closed loop system by analyzing the contour of the frequency response function on the complex plane.

### Peak Height

The largest peak measured from the bottom of the peak to the top of the peak:

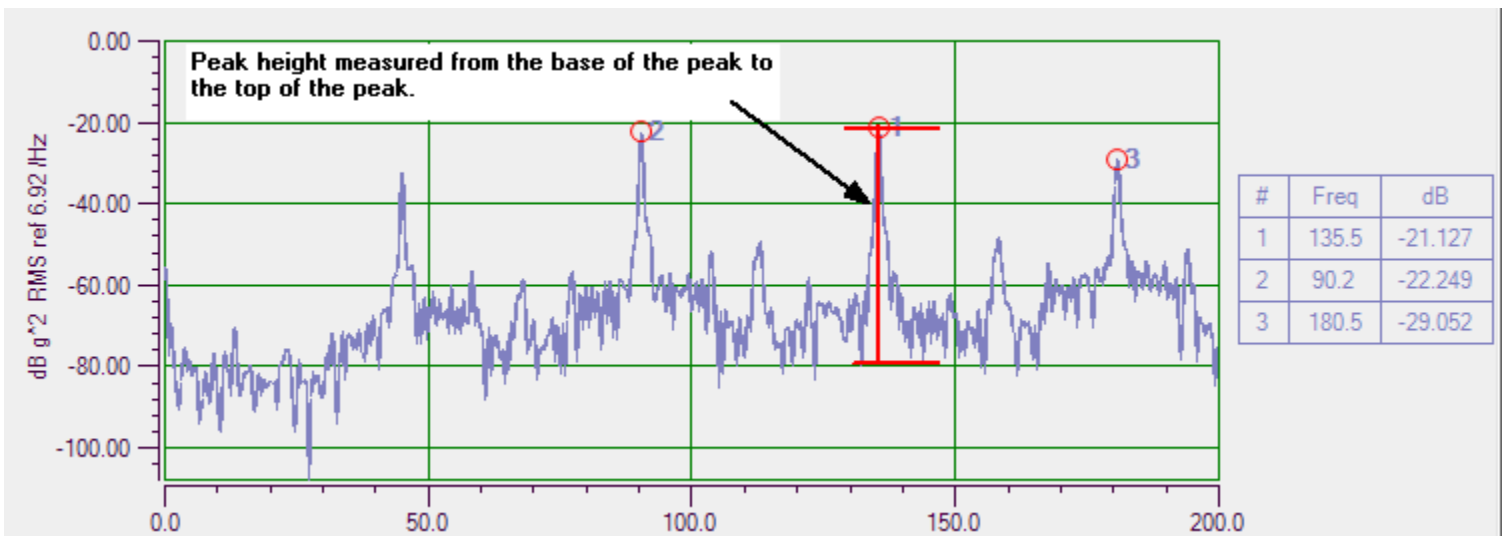

**Peak Scaling**

The absolute value of the data from zero to the peak.

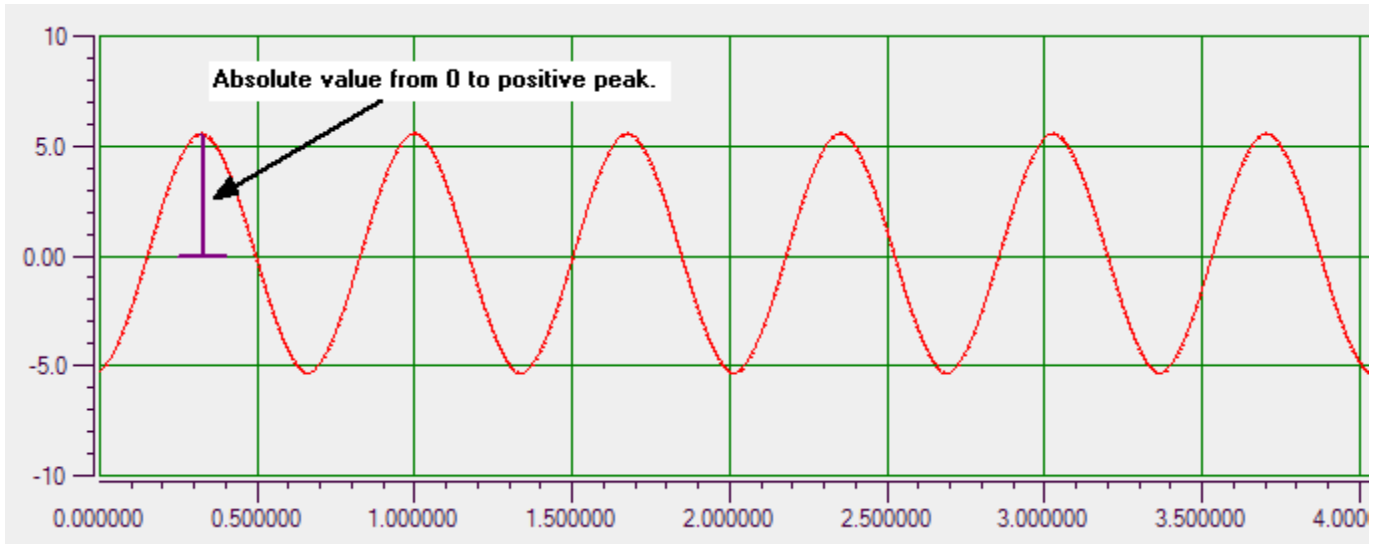

For example, the FFT plot for the above signal, appears as follows, where the peak height is just over 5 V:

**Peak Hold Averaging**

Each new FFT data point is compared with the current FFT data point, and the highest amplitude (peaks) from each FFT are retained. This is a continuous operation that combines the results of several measurements into a final FFT measurement.

**Phase Display Function**

Plots the frequency response phase shift (angle).

**Pink Noise**

Pink noise is sometimes referred to as  $1/f$  or flicker noise. In the frequency domain, the response is not flat. The power spectral density is inversely proportional to the frequency. Therefore, as the frequency increases, the power density decreases.

## Pk-Pk Scaling

The absolute value of the data from the negative peak to the positive peak.

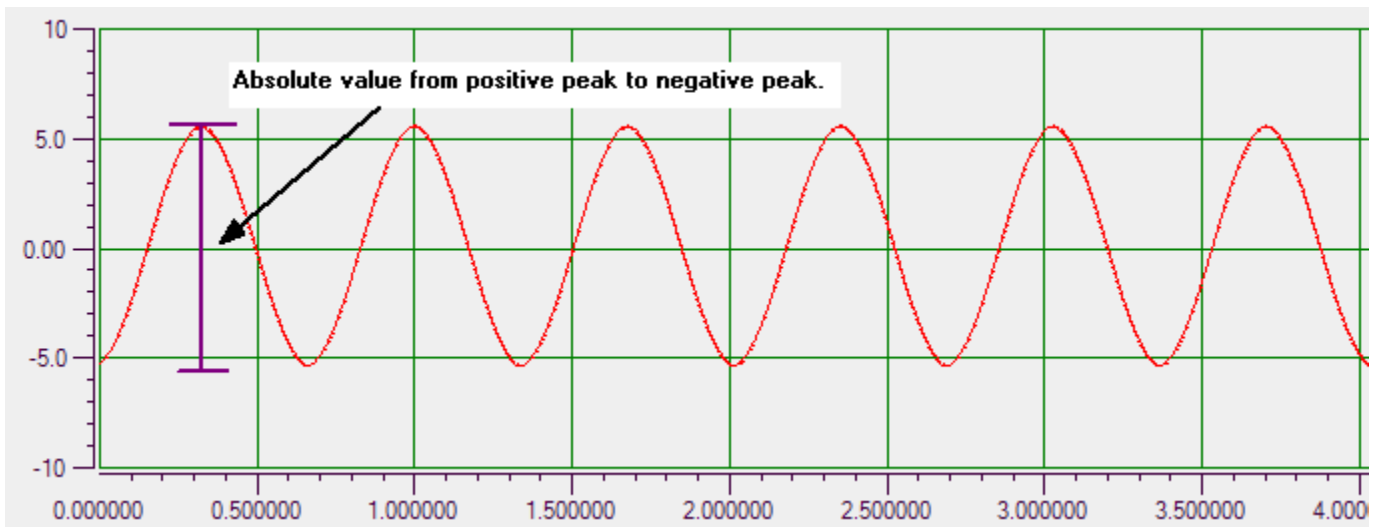

## Power

The power in each frequency component represented by the FFT is calculated by squaring the magnitude of the frequency component.

## Power Spectral Density (PSD)

The power of random vibration intensity as “mean-square acceleration per frequency unit.” The spectrum is computed by squaring the magnitude of each frequency component in the FFT, and dividing this number by the change in frequency multiplied by the equivalent noise bandwidth of the windowing function (ENBW). For an accelerometer, for example, the units for PSD are represented as  $g^2/Hz$ . Typically, **PSD** is best for wideband, continuous signals.

## Ramp Waveform

A non-sinusoidal waveform that ramps up and then drops sharply. This is sometimes called a sawtooth waveform.

## Random Noise

White noise that is created with a software generator function. With white noise, the signal has a flat response in the frequency domain; it has an equal power in any band of a given bandwidth (power spectral density). In the time domain, the amplitudes of the signal form a flat histogram since all amplitude values are equally probable.

## Random Normal Noise

White noise whose amplitude in the time domain has a Gaussian or normal distribution. The frequency content is the same as the Random noise type, having a flat response in the frequency domain.

## Record

A block of data whose length is equal to the size of the FFT.

## Rectangular Window

No window. Recommended for use when your signal content contains random noise (white noise) or closely spaced sine waves.

**RMS**

Root Mean Square. The square root of the average of the square of the value of the function taken throughout one period.

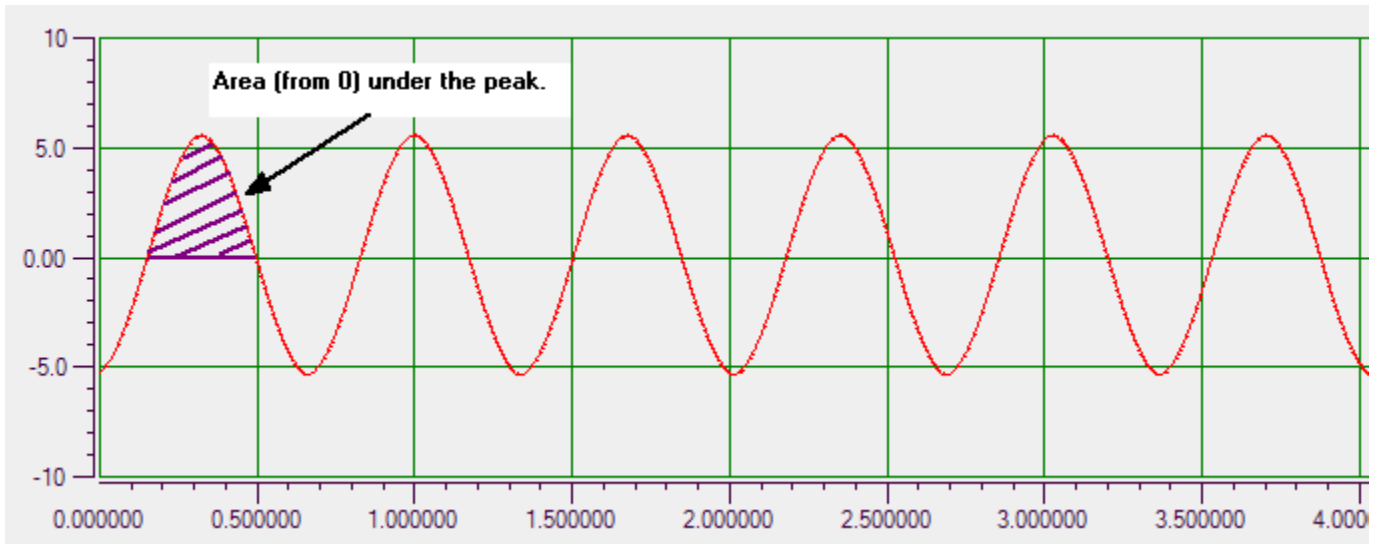
**SFDR**

Spurious free dynamic range, returned in dB, represents the level of the full-scale range to the greatest noise or distortion component. Refer to [page 242](#) for more information.

**SINAD**

Signal-to-noise and distortion ratio, returned in dB, represents the level of the main signal component relative to the total noise,  $V_{RMS}$ , including harmonics. Refer to [page 243](#) for more information.

**Sine Waveform**

A sinusoidal, periodic waveform.

**Single Integration**

If you specify an accelerometer as the sensor type, single integration results in velocity (the engineering units change and are denoted with “~”).

**SNR**

Signal-to-noise ratio, returned in dB, represents the level of the main signal component relative to the total noise,  $V_{RMS}$ . Refer to [page 245](#) for more information.

---

## Spectral Density

The spectral density describes how the variance of time-series data is distributed with frequency. It is computed as follows:

$$\frac{\text{Spectrum}}{\text{Change in Frequency} \times \text{ENBW}}$$

where,

*ENBW* is the Equivalent Noise Bandwidth of the Windowing function.

For example, if you select **PSD (Power Spectral Density)** for the Spectrum Function setting when configuring the FFT parameters, the spectrum is computed by squaring the magnitude of each frequency component in the FFT, dividing this number by the change in frequency multiplied by the *ENBW*, and plotting the results. For example, if measuring acceleration with these settings, the units for power spectral density are represented as  $g^2/\text{Hz}$ .

## Spectral Leakage

When the signal being analyzed is not periodic, energy from a signal at a specified frequency can leak into nearby spectral bins causing spectral amplitude inaccuracies; this is called spectral leakage.

Applying a windowing function controls, but doesn't completely eliminate, the error by multiplying each data frame by a suitable time-domain weighting window.

## Spectrum

The frequency spectrum is a representation of a time-domain signal in the frequency domain. It is generated by performing an FFT on the signal.

For example, if you select **Spectrum** for the Spectrum Function setting when configuring the FFT parameters, the spectrum is computed by taking the magnitude of each frequency component in the FFT and plotting the results. For example, if measuring acceleration with these settings, the units are in *g*. Typically, **Spectrum** is best for narrowband, deterministic signals.

## Square Waveform

A non-sinusoidal waveform that is shaped like a square, alternating between two levels.

## Sweep Waveforms

A sine wave whose frequency changes over time. Swept sine waves provide the ability to test a device over a wide frequency range to determine if any resonances occur.

## THD

Total harmonic distortion, returned in dB and %, represents the level of the harmonic distortion of the first five harmonics relative to the main signal component. Refer to [page 240](#) for more information.

## Time Domain

When plotted, amplitudes are graphed in relation to time. Also see *Frequency Domain*.

**Triangle Waveform**

A non-sinusoidal waveform that is shaped like a triangle.

**Trigger**

An event that starts data acquisition. QuickDAQ supports a number of trigger types, including a software trigger, external TTL trigger, and a hardware or software threshold trigger.



## A

- A coefficients
  - RTD 95
  - thermistor 97
- About menu option 49
- absolute amplitude priority 228
- AC coupling 100
- acceleration 210, 217, 221
- acceleration measurement example 268
- Accept button 84, 136
- Acquisition Config window
  - Acquisition tab (Data Logger interface) 127
  - Freq tab (FFT Analyzer interface) 61, 130
  - Output tab 58, 63, 140
  - Recording tab (Data Logger interface) 121
  - Recording tab (FFT Analyzer interface) 59, 124
  - Trigger tab (FFT Analyzer interface) 62, 133
  - Window tab (Advanced FFT Analyzer option) 63, 138
  - Window tab (FFT Analysis option) 63, 137
- acquisition duration 122
- acquisition mode 20
- Acquisition Status window
  - Data Logger interface 84
  - FFT Analyzer interface 84
- Acquisition tab (Data Logger interface) 57, 127
- adding channels
  - Advanced FFT Analysis option 204
  - Coherence 206
  - Cross Spectrum 206
  - FFT Analysis option 204
  - Frequency Response Function (FRF) 206
  - single-channel FFT 205
  - time-domain channel 207
  - two-channel FFT 206
  - windowed time-domain channel 206
- Advanced FFT Analysis option 19
- amplitude display 210, 216, 221
- amplitude priority 228
- analog input channel settings
  - A coefficient, RTD 95
  - A coefficient, thermistor 97
  - B coefficient, RTD 95
  - B coefficient, thermistor 97
  - bridge type 109
  - C coefficient, RTD 96
  - C coefficient, thermistor 97
  - calibrate 105, 110
  - channel name 90
  - Configuration and Calibration wizard 102
  - coupling type 100
  - current 99
  - current source 100
  - direction 101
  - enable termination resistor 92, 99
  - enabling channels 89
  - engineering units 91, 93, 96, 97, 98, 99, 100, 105, 109, 114
  - excitation voltage 105, 109
  - gage factor 109
  - IEPE 100
  - input type 90
  - lead wire resistance 105, 109
  - maximum range 109
  - minimum range 109
  - nominal gage 105, 109
  - point # 92, 93, 96, 97, 98, 99, 101, 115
  - Poisson ratio 110
  - range 90, 100
  - reference channel 90
  - remote sense lines 105, 109
  - resistance 97
  - resistance range 97
  - response channel 90
  - RTD R0 coefficient 95
  - RTDs 93
  - sensor offset value 91, 93, 96, 97, 98, 99, 101, 115
  - sensor scaling factor 91, 101
  - sensor scaling value 115
  - sensor type 90, 92, 93, 97
  - sensor wiring 96, 97, 98
  - shunt resistor 102
  - strain 102
  - thermistors 96
  - thermocouples 92
  - transducer capacity 105
  - transducer rated output 105
  - voltage 90
- analog threshold negative edge trigger 128, 134
- analog threshold positive edge trigger 128, 134
- apparent mass 217
- AppData folder 36
- Apply settings to current data button 209

- auto retrigger [136](#)
- auto spectrum function [210](#)
- Auto-Hide pin [54](#)
- Auto-reprocess on parameter change checkbox [209](#)
- average [126](#)
- averaging mode [214](#)
- Averaging tab
  - Coherence channel [226](#)
  - Cross Spectrum channel [223](#)
  - FFT channels [213](#)
  - FRF channels [219](#)
- averaging type [214](#), [219](#), [223](#), [226](#)
- Axes Scroll control [73](#)
- Axes Zoom control [73](#)
- axis color
  - Data Logger interface [181](#)
  - FFT Analyzer interface [202](#)
- Axis Mouse Mode [47](#)
  - Scroll [47](#)
  - Zoom [47](#)

## B

- B coefficients
  - RTD [95](#)
  - thermistor [97](#)
- background color
  - Channel Display window (Data Logger interface) [186](#)
  - Channel Display window (FFT Analyzer interface) [234](#)
  - Channel Plot window (Data Logger interface) [181](#)
  - Channel Plot window (FFT Analyzer interface) [202](#)
- backup configuration file [45](#)
- band power cursor style [76](#)
- bands, signal
  - Data Logger interface [176](#)
  - FFT Analyzer interface [198](#)
- bandwidth [130](#)
- Bartlett window [137](#), [138](#)
- Base [18](#)
- Bessel filter [165](#)
- Blackman window [137](#), [138](#)
- BlackmanHarris window [137](#), [138](#)
- bridge configuration
  - Full Bridge Axial Poisson [109](#)
  - Full Bridge Bending [109](#)
  - Full Bridge Bending Poisson [109](#)
  - Half Bridge Bending [109](#)
  - Half Bridge Poisson [109](#)

- Quarter Bridge [109](#)
- Quarter Bridge Temp Comp [109](#)
- bridge type [109](#)
- bridge-based sensor example [316](#)
- burst output mode [144](#), [159](#)
- burst random example [347](#)
- Butterworth filter [165](#)
- buttons [50](#)

## C

- C coefficient [95](#)
- C coefficients
  - RTD [96](#)
  - thermistor [97](#)
- calibrate [105](#), [110](#)
- channel configuration [129](#), [131](#)
- Channel Display - Control tab
  - Data Logger interface [184](#)
  - FFT Analyzer interface [232](#)
- Channel Display - Style tab
  - Data Logger interface [186](#)
  - FFT Analyzer interface [234](#)
- Channel Display window [81](#)
  - background color (Data Logger interface) [186](#)
  - background color (FFT Analyzer interface) [234](#)
  - columns (Data Logger interface) [185](#)
  - columns (FFT Analyzer interface) [233](#)
  - Data Logger interface [182](#)
  - data reduction method (Data Logger interface) [185](#)
  - data reduction method (FFT Analyzer interface) [234](#)
  - display update rate (Data Logger interface) [185](#)
  - display update rate (FFT Analyzer interface) [233](#)
  - displaying channels (Data Logger interface) [182](#)
  - displaying channels (FFT Analyzer interface) [230](#)
  - FFT Analyzer interface [230](#)
  - foreground color (Data Logger interface) [186](#)
  - foreground color (FFT Analyzer interface) [234](#)
  - indicator style (Data Logger interface) [187](#)
  - indicator style (FFT Analyzer interface) [235](#)
  - label color (Data Logger interface) [186](#)
  - label color (FFT Analyzer interface) [234](#)
  - precision (Data Logger interface) [184](#)
  - precision (FFT Analyzer interface) [233](#)
- channel name [90](#), [142](#)
  - Configure Devices dialog [90](#), [142](#)
  - Plot and Data Config window [236](#)
  - Plot and Data Config window (Data Logger interface) [171](#), [182](#)

- Plot and Data Config window (FFT Analyzer interface) 193, 230
- Channel Plot - Control tab
  - Data Logger interface 179
  - FFT Analyzer interface 201
- Channel Plot - Style tab
  - Data Logger interface 181
  - FFT Analyzer interface 202
- Channel Plot window 68
  - axis color (FFT Analyzer interface) 202
  - background color (FFT Analyzer interface) 202
  - controls 72, 73, 74, 75, 76, 77
  - Data Logger interface 171
  - displaying channels (Data Logger interface) 171
  - displaying channels (FFT Analyzer interface) 193
  - displaying data cursors (FFT Analyzer interface) 195
  - FFT Analyzer interface 193
  - grid line color (FFT Analyzer interface) 202
  - grouping signal bands (Data Logger interface) 176
  - grouping signal bands (FFT Analyzer interface) 198
  - specifying plot columns (Data Logger interface) 174
  - specifying plot columns (FFT Analyzer interface) 196
  - specifying the trace color (Data Logger interface) 178
  - specifying the trace color (FFT Analyzer interface) 200
  - trace thickness (FFT Analyzer interface) 202
  - Undo 79
  - View Plot Full Screen 79
  - x-axis label (FFT Analyzer interface) 203
  - y-axis label (FFT Analyzer interface) 203
  - Zoom Full Out 79
  - Zoom In X 79
  - Zoom In Y 79
- channel visibility
  - Channel Display window (Data Logger interface) 183
  - Channel Display window (FFT Analyzer interface) 231
  - Data Logger interface 172, 183
  - FFT Analyzer interface 194, 231, 237
  - Statistics window (Data Logger interface) 188
  - Statistics window (FFT Analyzer interface) 237
- channels, enabling 89
- Chebyshev filter 165
- clock prescale 119
- Close Hpf Data menu option 37
- Coherence channels
  - adding 206
  - configuring 224
- coherence function 225
- Coherent Output Power function 225
- color
  - axis (Data Logger interface) 181
  - axis (FFT Analyzer interface) 202
  - background of Channel Display window (Data Logger interface) 186
  - background of Channel Display window (FFT Analyzer interface) 234
  - background of Channel Plot window (FFT Analyzer interface) 202
  - background of the Channel Plot window (Data Logger interface) 181
  - foreground of Channel Display window (Data Logger interface) 186
  - foreground of Channel Display window (FFT Analyzer interface) 234
  - grid line (Data Logger interface) 181
  - grid line (FFT Analyzer interface) 202
  - label for the Channel Display window (Data Logger interface) 186
  - label for the Channel Display window (FFT Analyzer interface) 234
  - trace (Data Logger interface) 178
  - trace (FFT Analyzer interface) 200
- Color column
  - Data Logger interface 178
  - FFT Analyzer interface 200
- Comma Delimited Text file format 38, 41
- compliance 217
- Config folder 44
- Configuration and Calibration wizard 102
- configuration file 44
  - saving and loading 120
- Configuration menu 47
- configuring channels in the Plot and Data config window
  - Coherence channels 224
  - Cross Spectrum channels 220
  - FRF channels 215
  - single FFT 209
- configuring digital filters 164
- configuring input channels 86
  - analog input channels (current) 99
  - analog input channels (IEPE) 100
  - analog input channels (resistance) 97
  - analog input channels (RTDs) 93

- analog input channels (strain) 102
  - analog input channels (thermistors) 96
  - analog input channels (thermocouples) 92
  - analog input channels (voltage) 90
  - changing the channel name 90
  - counter channels 117
  - digital input 115
  - enabling channels 89
  - enabling termination resistor 92, 99
  - engineering units 91, 93, 96, 97, 98, 99
  - quadrature decoder channels 119
  - resistance range 97
  - selecting the input type 90
  - sensor offset value 91, 93, 96, 97, 98, 99
  - sensor scaling factor 91
  - sensor type 90, 92, 93, 97
  - sensor wiring 98
  - tachometer channels 115
  - test point number 92, 93, 96, 97, 98, 99
  - configuring statistic for FFT plots 227
  - configuring the plot style
    - Data Logger interface 181
    - FFT Analyzer interface 202
  - continuous acquisition 122, 125
  - continuous output mode 144, 159
  - Control tab
    - Channel Display (Data Logger interface) 184
    - Channel Display (FFT Analyzer interface) 232
    - Channel Plot (Data Logger interface) 179
    - Channel Plot (FFT Analyzer interface) 201
  - controls of the Channel Plot window 72
    - Axes Scroll 73
    - Axes Zoom 73
    - Copy to Clipboard 76
    - Data Cursor 75
    - Link Cursors to Selected 74
    - Link X Axes to Selected 74
    - Link Y Axes to Selected 74
    - Page Setup 77
    - Preview 77
    - Print 77
    - Save Plot Image 77
    - Select 75
    - Show Data Point Markers 77
    - Show Legend 77
    - Tracking Pause 73
    - Tracking Resume 72
    - Zoom All to Fit in View Y 73
    - Zoom Box 75
    - Zoom-In All 73
    - Zoom-Out All 73
  - conventions used 16
  - COP function 225
  - Copy plot data to clipboard menu option 45
  - Copy plot image to clipboard 45
  - Copy to Clipboard control 76
  - cosine taper window 139
  - counter settings 117
    - engineering units 117
    - mSec per Hz 117
    - start edge 118
    - stop edge 118
  - coupling type 100
  - cross power spectral density function 221
  - Cross Spectrum channels
    - adding 206
    - configuring 220
  - cross spectrum function 221
  - csv file format 38, 41
  - current source 100
  - cursor style
    - band power 76
    - frequency 75
    - peak-peak 75
    - period 75
    - value-XY 75
  - custom FRF mode 217
  - cutoff frequency 166
- ## D
- dash line style 76
  - dashdot line style 76
  - Data Cursor control 75
  - data cursors
    - Data Logger interface 173
    - FFT Analyzer interface 195
  - data file 36, 50
  - data file name 39, 42, 121, 122, 125
  - Data folder 39, 42, 43, 44, 77
  - Data Logger interface
    - Acquisition Config window 56
    - Acquisition Status window 84
    - Export Data 37
    - Lock to acquisition time 144, 148, 159
    - Open Current Data in Excel 43
    - Plot and Data Config window 65
    - Recording tab 121
  - Data Logger menu option 48
  - data reduction method
    - Data Logger interface 185
    - FFT Analyzer interface 234

- data-cursor control
  - Data Logger interface [173](#)
  - FFT Analyzer interface [195](#)
- dB reference [212, 222](#)
- dB ripple [167](#)
- dB scaling [211, 218, 222](#)
- DC coupling [100](#)
- Device Selection window [27](#)
- device status [84](#)
- differential channel configuration [129, 131](#)
- Digital Filter Configuration button [51](#)
- Digital Filter Configuration menu option [164](#)
- Digital Filter Configuration toolbar button [164](#)
- digital filter example [377](#)
- digital filters [164](#)
- digital input settings [115](#)
- digits after decimal point [69, 71](#)
- disable plotting during acquisition
  - FFT Analyzer interface [201](#)
- disable plotting during acquisition (Data Logger interface) [179](#)
- displacement [210, 217, 221](#)
- Display Day checkbox (Data Logger interface) [180](#)
- display function
  - Advanced FFT Analysis option [210](#)
  - Cross Spectrum channel [221](#)
  - FFT Analysis option [210](#)
  - FFT channel [210](#)
  - FRF channel [216](#)
- display update rate
  - Data Logger interface [185](#)
  - FFT Analyzer interface [233](#)
- displaying channels
  - Channel Display window (Data Logger interface) [182](#)
  - Channel Display window (FFT Analyzer interface) [230](#)
  - Channel Plot window (Data Logger interface) [171](#)
  - Channel Plot window (FFT Analyzer interface) [193](#)
- displaying data cursors
  - Data Logger interface [173](#)
  - FFT Analyzer interface [195](#)
- docking windows [53](#)
- dot line style [76](#)
- dynamic performance statistics [238](#)
- dynamic stiffness [217](#)
- edge sensitivity [228](#)
- edge, counters [118](#)
- Edit menu [45](#)
  - Copy plot data to clipboard [45](#)
  - Copy plot image to clipboard [45](#)
- editing label of x-axis [71](#)
- effective number of bits [246](#)
- enable averaging [214, 219, 223, 226](#)
- enable termination resistor [92, 99](#)
- enabling channel display
  - Channel Display window (Data Logger interface) [183](#)
  - Channel Display window (FFT Analyzer interface) [231](#)
  - Channel Plot window (Data Logger interface) [172](#)
  - Channel Plot window (FFT Analyzer interface) [194](#)
  - Statistics window (Data Logger interface) [188](#)
  - Statistics window (FFT Analyzer interface) [237](#)
- enabling channels [89](#)
- enabling output channels [142](#)
- engineering unit offset [91, 93, 96, 97, 98, 99, 101, 115](#)
- engineering unit scaling [115](#)
- engineering units [91, 93, 96, 97, 98, 99](#)
  - analog input [100, 105, 109, 114](#)
  - counter [117](#)
  - quadrature decoder [119](#)
  - tachometer [115](#)
- ENOB [246](#)
- examples [267](#)
  - acceleration measurement [268](#)
  - bridge-based sensor [316](#)
  - digital filter [377](#)
  - free run swept sine [329](#)
  - impact testing [283](#)
  - strain gage [303](#)
  - triggered burst random [347](#)
- excitation voltage [105, 109](#)
- Exit menu option [45](#)
- Exit without saving current configuration menu option [45](#)
- exponential averaging [214, 219, 223, 226](#)
- exponential frequency change (sweep) [147](#)
- exponential window [139](#)
- Export Data button [50](#)
- Export Data menu option [37](#)
  - Data Logger interface [37](#)
  - FFT Analyzer interface [40](#)
- external TTL negative-edge trigger [128](#)
- external TTL positive-edge trigger [128, 134](#)

## E

edge of tachometer [116](#)

**F**

- features 18
- FFT Analysis option 18
- FFT Analyzer interface
  - Acquisition Config window 59
  - Acquisition Status window 84
  - Export Data 40
  - Lock to acquisition time 144, 148, 159
  - Lock to analysis frame time 144, 159
  - Open Current Data in Excel 43
  - Plot and Data Config window 66
  - Recording tab 124
- FFT Analyzer menu option 48
- FFT size 131
- file formats
  - csv 38, 41
  - txt 38, 41
  - uff 41
- File menu 36
  - Close Hpf Data File menu 37
  - Exit 45
  - Exit without saving current configuration 45
  - Export Data menu 37, 40
  - Load Configuration 44
  - New Hpf Data File 36
  - Open Current Data in Excel 43
  - Open Export Data Folder 44
  - Open Hpf Data File 36
  - Open Hpf Data Folder 44
  - Page Setup 45
  - Print 45
  - Print Preview 45
  - Save Configuration 44
  - Save Current Plot Image 43
- file reader mode 20
- filename base 122, 125
- filename generation 39, 42, 121, 125
- filter status indicator 165
- filter type 128, 132
- filters
  - band-pass 166
  - band-stop 166
  - Bessel 165
  - Butterworth 165
  - category 166
  - channels 165
  - Chebyshev 165
  - cutoff frequency 166
  - dB ripple 167
  - filter order 166
  - frequency response 167
  - high-pass 166
  - IIR 164
  - impulse response 167, 168
  - low-pass 166
  - status indicators 165
  - types 165
- fixed waveforms 143
- flat top window 138
- force window 139
- foreground color
  - Channel Display window (Data Logger interface) 186
  - Channel Display window (FFT Analyzer interface) 234
- format of axis
  - x-axis 71
  - y-axis 70
- free run swept sine example 329
- free run trigger 134
- Freq tab (FFT Analyzer interface) 61, 130
- frequency cursor style 75
- frequency of acquisition 127
- frequency response 167
- FRF channels
  - adding 206
  - configuring 215
- FRF estimator 216
- FRF mode 217
- Full Bridge Axial Poisson configuration 109
- Full Bridge Bending configuration 109
- Full Bridge Bending Poisson configuration 109
- full-bridge-based sensor parameters 104
- Function tab
  - Coherence channel 224
  - Cross Spectrum channel 220
  - FFT channels 209
  - FRF channels 216

**G**

- gage factor 109
- Gaussian distribution 155
- getting started 27
- glossary 389
- grid line color
  - Data Logger interface 181
  - FFT Analyzer interface 202
- gridlines
  - x-axis 71
  - y-axis 69

grouping signal bands

- Data Logger interface [176](#)
- FFT Analyzer interface [198](#)

## H

- H1 [216](#)
- H2 [216](#)
- H3 [216](#)
- Half Bridge Bending configuration [109](#)
- Half Bridge Poisson configuration [109](#)
- hammer impact test [283](#)
- Hamming window [137](#), [138](#)
- Hanning window [137](#), [138](#)
- hardware TEDS [104](#)
- header
  - Channel Plot window (Data Logger interface) [181](#)
  - Channel Plot window (FFT Analyzer interface) [202](#)
- height of the plot
  - Data Logger interface [180](#)
  - FFT Analyzer interface [202](#)
- Help button [52](#)
- Help menu [49](#)
  - About [49](#)
  - License Info [49](#)
  - User Manual [49](#)
- Hide Unused Channels checkbox
  - Data Logger interface [184](#)
  - FFT Analyzer interface [232](#)
- Hide/show columns button
  - Color (Data Logger interface) [178](#)
  - Color (FFT Analyzer interface) [200](#)
  - Plot Column (Data Logger interface) [176](#)
  - Plot Column (FFT Analyzer interface) [197](#)
  - Show Cursor (Data Logger interface) [174](#)
  - Show Cursor (FFT Analyzer interface) [196](#)
  - Signal Group (Data Logger interface) [177](#)
  - Signal Group (FFT Analyzer interface) [199](#)
  - Visible Display (Data Logger interface) [183](#)
  - Visible Display (FFT Analyzer interface) [231](#)
  - Visible Plot (Data Logger interface) [172](#)
  - Visible Plot (FFT Analysis interface) [194](#)
  - Visible Statistics (Data Logger interface) [189](#)
  - Visible Statistics (FFT Analyzer interface) [237](#)
- hiding columns
  - Color column (Data Logger interface) [178](#)
  - Color column (FFT Analyzer interface) [200](#)
  - Plot column (Data Logger interface) [176](#)
  - Plot column (FFT Analyzer interface) [197](#)
  - Show Cursor column (Data Logger interface) [174](#)

- Show Cursor column (FFT Analyzer interface) [196](#)
  - Signal Group column (Data Logger interface) [177](#)
  - Signal Group column (FFT Analyzer interface) [199](#)
  - Visible Display column (Data Logger interface) [183](#)
  - Visible Display column (FFT Analyzer interface) [231](#)
  - Visible Plot column (Data Logger interface) [172](#)
  - Visible Statistics column (Data Logger interface) [189](#)
  - Visible Statistics column (FFT Analyzer interface) [237](#)
- hiding windows [54](#)

## I

- IBF [239](#)
- IIR filters [164](#)
- imaginary display [210](#), [216](#), [221](#)
- impact testing example [283](#)
- impedance [217](#)
- impulse response [167](#), [168](#)
- index mode [119](#)
- indicator style
  - Channel Display window (Data Logger interface) [187](#)
  - Channel Display window (FFT Analyzer interface) [235](#)
- inertance [217](#)
- input below full-scale [239](#)
- Input Channel Configuration button [51](#)
- Input Channel Configuration menu option [86](#)
- Input Channel Configuration toolbar button [86](#)
- input type [90](#)
  - Configure Devices dialog [90](#)
- input voltage range [90](#), [100](#), [129](#), [131](#)
- installing the software [26](#)
- integration type [210](#), [217](#), [221](#)
- interface [34](#)
- interval [123](#), [130](#)
- IP address [28](#)

## L

- label
  - X-axis (Data Logger interface) [181](#)
  - X-axis (FFT Analyzer interface) [203](#)
  - Y-axis (Data Logger interface) [181](#)
  - Y-axis (FFT Analyzer interface) [203](#)

- label color
    - Channel Display window (Data Logger interface) 186
    - Channel Display window (FFT Analyzer interface) 234
  - label for x-axis, editing 71
  - LAN triggers 134
  - lead wire resistance 105, 109
  - left edge 79
  - License Info menu option 49
  - licensing requirements 21
  - lin/log scaling
    - x-axis 71
    - y-axis 70
  - line style
    - dash 76
    - dashdot 76
    - dot 76
    - solid 76
  - linear averaging 214, 219, 223, 226
  - linear frequency change (sweep) 147
  - linear scaling 211, 218, 222, 225
  - Link Cursors to Selected control 74
  - Link Time Series Data checkbox 84, 229
  - Link X Axes to Selected control 74
  - Link Y Axes to Selected control 74
  - Load Configuration menu option 44
  - Lock to acquisition time 161
    - Data Logger interface 144, 148, 159
    - FFT Analyzer interface 144, 148, 159
  - Lock to analysis frame time 144, 148, 159, 161
  - Lock to analysis freq 160
  - log10 scaling 211, 218, 222, 225
  - logarithmic frequency change (sweep) 147
  - loop sweep mode 147
  - LXI triggers 134
- M**
- maximum number of peaks to detect 228
  - maximum range 109
  - maximum RPM value 115
  - maximum value 246
  - mean value 246
  - menus 36
    - Configuration 47
    - Edit 45
    - File 36
    - Help 49
    - Mode 48
    - Plot 46
    - Record 46
    - Windows 48
  - minimum range 109
  - minimum value 246
  - mobility 217
  - Mode menu 48
    - Data Logger 48
    - FFT Analyzer interface 48
  - modes of operation 20
    - acquisition 20
    - file reader 20
  - monitoring the analog output signal 259, 366
  - moving columns
    - Color column (Data Logger interface) 178
    - Color column (FFT Analyzer interface) 200
    - Plot column (Data Logger interface) 176
    - Plot column (FFT Analyzer interface) 197
    - Show Cursor column (Data Logger interface) 174
    - Show Cursor column (FFT Analyzer interface) 196
    - Signal Group column (Data Logger interface) 177
    - Signal Group column (FFT Analyzer interface) 200
    - Visible Display column (Data Logger interface) 183
    - Visible Display column (FFT Analyzer interface) 231
    - Visible Plot column (Data Logger interface) 172
    - Visible Plot column (FFT Analyzer interface) 194
    - Visible Statistics column (Data Logger interface) 189
    - Visible Statistics column (FFT Analyzer interface) 237
  - moving windows 53
  - Multi-channel Actions button
    - Disable all Channels 89
    - Disable all Selected Channels 89
    - Enable all Channels 89
    - Enable all Selected Channels 89
    - Selected channels hidden in Channel Display (Data Logger interface) 183
    - Selected channels hidden in Channel Display (FFT Analyzer interface) 231
    - Selected channels hidden in Channel Plot (Data Logger interface) 172
    - Selected channels hidden in Channel Plot (FFT Analyzer interface) 194
    - Selected channels hidden in Statistics Display (Data Logger interface) 188
    - Selected channels hidden in Statistics Display (FFT Analyzer interface) 237



Selected channels Plot Column (Data Logger interface) 175

Selected channels Plot Column (FFT Analyzer interface) 197

Selected channels Signal Group (Data Logger interface) 177

Selected channels Signal Group (FFT Analyzer interface) 199

Selected channels visible in Channel Display (Data Logger interface) 183

Selected channels visible in Channel Display (FFT Analyzer interface) 231

Selected channels visible in Channel Plot (Data Logger interface) 172

Selected channels visible in Channel Plot (FFT Analyzer interface) 194

Selected channels visible in Statistics Display (Data Logger interface) 188

Selected channels visible in Statistics Display (FFT Analyzer interface) 237

Selected data cursors hidden 173, 195

Selected data cursors visible 173, 195

Set all Channel Coupling 100

Set all Channel Current Source 100

Set all Channel Units 101

Set all Filter Types 166

Set all Multi-Range Channels 91

Set all RTD Channels 94

Set all Selected Channel Units 91, 101

Set all Thermocouple Channels 92

Set all Voltage Channel Units 91

muting the output signal 162

mV per engineering unit 91, 101

## N

naming channels 90, 142, 236

- Data Logger interface 171, 182
- FFT Analyzer interface 193, 230

New HPF Data File button 50

New Hpf Data menu option 36

noise waveforms 152

nominal gage 105, 109

number of averages 126, 130

number of poles 166

number of records 126

number of scans 123, 130

Nyquist display 210, 216, 221

## O

offset 91, 93, 96, 97, 98, 99, 101, 115, 142

offset nulling 105, 110

Open Current Data in Excel button 50

Open Current Data in Excel menu option

- Data Logger interface 43
- FFT Analyzer interface 43

Open Current Data in Excel toolbar button 43

Open Export Data Folder menu option 44

Open HPF Data File button 50

Open Hpf Data Folder menu option 44

Open Hpf Data menu option 36

order of filter 166

output frequency 143, 160

output frequency change 147

output mode 144, 159

Output tab 140

- channel name 142
- Data Logger interface 58
- enabling channels 142
- FFT Analyzer interface 63
- muting and unmuting the output signal 162
- offset 142
- peak voltage 142
- Start methods 161
- Stop methods 161
- waveform types 142

## P

page left 79

page right 79

Page Setup control 77

Page Setup menu option 45

Pause menu option 46

pause tracking 72

peak detection 228

peak hold averaging 214

peak scaling 212, 222

peak to peak scaling 212, 222

peak voltage 142

peak-peak cursor style 75

period cursor style 75

phase display 210, 216, 221

pink noise 157

Plot and Data Config window 65

- adding channels using the Advanced FFT Analysis option 204
- adding channels using the FFT Analysis option 204
- Data Logger interface 65

- FFT Analyzer interface 66
- removing channels 208
- Plot Area Mouse Mode 46
  - Cursor 47
  - Select 46
  - Zoom 46
- plot columns
  - changing the value for all channels at once (Data Logger interface) 175
  - changing the value for all channels at once (FFT Analyzer interface) 197
- Data Logger interface 174
- FFT Analyzer interface 196
- moving (Data Logger interface) 176
- moving (FFT Analyzer interface) 197
- showing or hiding (Data Logger interface) 176
- showing or hiding (FFT Analyzer interface) 197
- plot header
  - Data Logger interface 181
  - FFT Analyzer interface 202
- plot height
  - Data Logger interface 180
  - FFT Analyzer interface 202
- Plot menu 46
  - Cursor (Plot Area Mouse Mode) 47
  - Scroll (Axis Mouse Mode) 47
  - Select (Plot Area Mouse Mode) 46
  - Zoom (Axis Mouse Mode) 47
  - Zoom (Plot Area Mouse Mode) 46
- plot style
  - Data Logger interface 181
  - FFT Analyzer interface 202
- plot update rate
  - Data Logger interface 179
  - FFT Analyzer interface 201
- point # 92, 93, 96, 97, 98, 99, 101, 115
- Poisson ratio 110
- poles, filter 166
- power options 386
- power spectral density function 210
- precision
  - Channel Display window (Data Logger interface) 184
  - Channel Display window (FFT Analyzer interface) 233
  - x-axis 71
  - y-axis 69
- pre-trigger data 136
- Preview control 77
- Print control 77
- Print menu option 45

- Print Preview menu option 45
- priority, absolute amplitude 228
- PSD 210
- pseudo random noise 160

## Q

- quadrature decoder channel settings 119
- quadrature decoder settings 119
  - clock prescale 119
  - engineering units 119
  - index mode 119
  - pulses/rev 119
  - X4 scaling 119
- Quarter Bridge configuration 109
- Quarter Bridge Temp Comp configuration 109
- QuickDAQ options
  - Advanced FFT Analysis 19
  - Base 18
  - FFT Analysis 18

## R

- R0 coefficients 95
- ramp down time 144, 149, 160
- ramp up time 144, 149, 160
- ramp wave 143
- random noise 153
- random normal noise 155
- range 90, 100
- real display 210, 216, 221
- record 126
- Record button 51
- Record menu 46
  - Pause 46
  - Record 46
  - Stop 46
  - View 46
- Record menu option 46
- Record Number 84, 229
- Recording tab
  - Data Logger interface 56, 121
  - FFT Analyzer interface 59, 124
- rectangular window 137, 138
- reference channel 90, 216, 221, 225
- reference integration 221
- Reject button 84, 136
- related documents 16
- remote sense lines 105, 109
- removing channels 208
- requirements, licensing 21

- Reset Windows Layout to Default Layout menu
    - option [35, 48](#)
  - Reset Windows Layout to Last Saved menu option [48](#)
  - resetting the window layout [55](#)
  - resistance range [97](#)
  - resizing windows [53](#)
  - resolution [23](#)
  - response channels [90](#)
  - response integration [221](#)
  - resume tracking [72](#)
  - retrigger [136](#)
  - right edge [79](#)
  - ripple, dB [167](#)
  - RMS averaging [214, 238](#)
  - RMS scaling [212, 222](#)
  - RPM multiplier [116](#)
  - RPM value [115](#)
  - RTD channels
    - A coefficient [95](#)
    - B coefficient [95](#)
    - C coefficient [95](#)
    - R0 coefficient [95](#)
- ## S
- sample hpf file [36, 50](#)
  - sample interval [123, 130](#)
  - sample rate [123, 130](#)
  - sampling frequency [127](#)
  - sampling rate [130](#)
  - Save Configuration menu option [44](#)
  - Save Current Plot Image menu option [43](#)
  - Save Plot Image control [77](#)
  - scaling [115](#)
    - x-axis [71](#)
    - y-axis [69](#)
  - Scaling tab
    - Coherence function [225](#)
    - Cross Spectrum channel [222](#)
    - FFT channels [211](#)
    - FRF channels [218](#)
  - scans [123, 130](#)
  - scroll here [79](#)
  - scroll left [79](#)
  - scroll right [80](#)
  - scrollbar, x-axis [46, 51, 72, 73](#)
  - scrolling options [79](#)
    - left edge [79](#)
    - page left [79](#)
    - page right [79](#)
    - right edge [79](#)
    - scroll here [79](#)
    - scroll left [79](#)
    - scroll right [80](#)
  - scrolling through FFTs [229](#)
  - seeing hidden files [36](#)
  - Select control [75](#)
  - selecting the type of input for the channel [90](#)
  - sensitivity, edge [228](#)
  - sensor direction [101](#)
  - sensor offset value [91, 93, 96, 97, 98, 99, 101, 115](#)
  - sensor scaling factor [91, 101](#)
  - sensor scaling value [115](#)
  - sensor type [90, 92, 93, 97](#)
  - sensor wiring [96, 97, 98](#)
  - setting up the x-axis [70](#)
  - setting up the y-axis [69](#)
  - SFDR [242](#)
  - Show Cursor column
    - Data Logger interface [173](#)
    - FFT Analyzer interface [195](#)
  - show data cursors [173](#)
    - Data Logger interface [173](#)
    - FFT Analyzer interface [195](#)
  - Show Data Point Markers control [77](#)
  - Show Dynamic Performance Stats [238](#)
  - show FFT peaks [227](#)
  - Show Legend control [77](#)
  - Show Min/Max/Mean Stats [246](#)
  - Show trigger markers in plot [136](#)
  - showing columns
    - Color column (Data Logger interface) [178](#)
    - Color column (FFT Analyzer interface) [200](#)
    - Plot column (Data Logger interface) [176](#)
    - Plot column (FFT Analyzer interface) [197](#)
    - Show Cursor column (Data Logger interface) [174](#)
    - Show Cursor column (FFT Analyzer interface) [196](#)
    - Signal Group (Data Logger interface) [177](#)
    - Signal Group (FFT Analyzer interface) [199](#)
    - Visible Display (Data Logger interface) [183](#)
    - Visible Display (FFT Analyzer interface) [231](#)
    - Visible Plot column (Data Logger interface) [172](#)
    - Visible Plot column (FFT Analyzer interface) [194](#)
    - Visible Statistics column (Data Logger interface) [189](#)
    - Visible Statistics column (FFT Analyzer interface) [237](#)
  - shunt calibration [105, 110](#)
  - shunt resistor [102](#)

- signal bands
    - Data Logger interface [176](#)
    - FFT Analyzer interface [198](#)
  - Signal Group column
    - changing the value for all selected channels at once (Data Logger interface) [177](#)
    - changing the value for all selected channels at once (FFT Analyzer interface) [199](#)
    - Data Logger interface [176](#)
    - FFT Analyzer interface [198](#)
    - moving (Data Logger interface) [177](#)
    - moving (FFT Analyzer interface) [200](#)
    - showing or hiding column (Data Logger interface) [177](#)
    - showing or hiding column (FFT Analyzer interface) [199](#)
  - signal-to-noise and distortion ratio [243](#)
  - signal-to-noise ratio [245](#)
  - SINAD [243](#)
  - sine wave [143](#)
  - single sweep mode [147](#)
  - single-channel FFTs
    - adding [205](#)
    - configuring [209](#)
  - single-ended channel configuration [129](#), [131](#)
  - smooth scrolling
    - Data Logger interface [179](#)
    - FFT Analyzer interface [201](#)
  - SNR [245](#)
  - software trigger [128](#)
  - software triggered [134](#)
  - solid line style [76](#)
  - span [130](#)
  - specifying plot columns of the Channel Plot window
    - Data Logger interface [174](#)
    - FFT Analyzer interface [196](#)
  - specifying the trace color
    - Data Logger interface [178](#)
    - FFT Analyzer interface [200](#)
  - spectrum function [210](#)
  - spurious free dynamic range [242](#)
  - square wave [143](#)
  - standard deviation [246](#)
  - start edge, counters [118](#)
  - Statistics window [82](#)
    - Data Logger interface [188](#)
    - displaying channels (FFT Analyzer interface) [236](#)
    - FFT Analyzer interface [236](#)
  - statistics, configuring [227](#)
  - Stats tab [227](#), [237](#)
  - status [84](#)
  - status indicator, filters [165](#)
  - Stop button [51](#)
  - stop edge, counters [118](#)
  - Stop menu option [46](#)
  - strain
    - maximum [109](#)
    - minimum [109](#)
  - strain gage example [303](#)
  - strain gage parameters [108](#)
  - Style button [52](#)
  - Style tab
    - Channel Display (Data Logger interface) [186](#)
    - Channel Display (FFT Analyzer interface) [234](#)
    - Channel Plot (Data Logger interface) [181](#)
    - Channel Plot (FFT Analyzer interface) [202](#)
  - support [387](#)
  - supported devices [19](#)
  - sweep mode [147](#)
  - sweep off time [148](#)
  - sweep on time [148](#)
  - sweep output frequencies [148](#)
  - sweep waveforms [146](#)
  - swept sine example [329](#)
- ## T
- Tab Delimited Text file format [38](#), [41](#)
  - tabs
    - Acquisition (Data Logger interface) [57](#)
    - Recording (Data Logger interface) [56](#)
  - tachometer settings [115](#)
    - edge [116](#)
    - engineering units [115](#)
    - mSec per Hz [116](#)
    - RPM multiplier [116](#)
    - RPM value [115](#)
    - ticks per revolution [115](#)
  - technical support [387](#)
  - TEDS [104](#)
  - temperature units [129](#), [131](#)
  - test point number [92](#), [93](#), [96](#), [97](#), [98](#), [99](#), [101](#), [115](#)
  - THD [240](#)
  - threshold channel [135](#)
  - threshold trigger [128](#), [134](#)
  - threshold value [135](#)
  - ticks per revolution [115](#)
  - time-domain channels, adding [207](#)
  - time-domain x-axis units
    - Data Logger interface [180](#)
    - FFT Analyzer interface [201](#)

toolbar buttons [50](#)  
   Digital Filter Configuration [51](#)  
   Export Data [50](#)  
   Help [52](#)  
   Input Channel Configuration [51](#)  
   New HPF Data File [50](#)  
   Open Current Data in Excel [43, 50](#)  
   Open HPF Data File [50](#)  
   Record [51](#)  
   Stop [51](#)  
   Style [52](#)  
   View [51](#)  
 total harmonic distortion [240](#)  
 trace color  
   Data Logger interface [178](#)  
   FFT Analyzer interface [200](#)  
 trace thickness  
   Data Logger interface [181](#)  
   FFT Analyzer interface [202](#)  
 tracking  
   Pause [72, 73](#)  
   Resume [72](#)  
 transducer capacity [105](#)  
 transducer rated output [105](#)  
 triangle wave [143](#)  
 triaxial accelerometer [268](#)  
 trigger mode [136](#)  
 trigger sources  
   analog threshold negative edge [128, 134](#)  
   analog threshold positive edge [128, 134](#)  
   external TTL negative-edge [128](#)  
   external TTL positive edge [134](#)  
   external TTL positive-edge [128](#)  
   free run [134](#)  
   LAN [134](#)  
   LXI [134](#)  
   software [128](#)  
   software triggered [134](#)  
 Trigger tab (FFT Analyzer interface) [62, 133](#)  
 triggered burst random example [347](#)  
 troubleshooting checklist [386](#)  
 true random noise [160](#)  
 two-channel FFT channels, adding [206](#)  
 txt file format [38, 41](#)

## U

uff file format [41](#)  
 Undo zoom option [79](#)

units  
   engineering [91, 93, 96, 97, 98, 99, 100, 105, 109, 114, 115, 117, 119](#)  
   time-domain x-axis (Data Logger interface) [180](#)  
   time-domain x-axis (FFT Analyzer interface) [201](#)  
 Universal File Format [41](#)  
 unmuting the output signal [162](#)  
 user accept [136](#)  
 user interface [34](#)  
 user reject [136](#)

## V

value X-Y cursor style [75](#)  
 vector averaging [214, 238](#)  
 velocity [210, 217, 221](#)  
 View button [51](#)  
 View menu option [46](#)  
 View Plot Full Screen zoom option [79](#)  
 virtual TEDS [104](#)  
 visibility  
   channels in Channel Display window (Data Logger interface) [183](#)  
   channels in Channel Display window (FFT Analyzer interface) [231](#)  
   channels in Channel Plot window (Data Logger interface) [172](#)  
   channels in Channel Plot window (FFT Analyzer interface) [194](#)  
   channels in Statistics window (Data Logger interface) [188](#)  
   channels in Statistics window (FFT Analyzer interface) [237](#)  
   channels in the Statistics window (Data Logger interface) [188](#)  
   channels in the Statistics window (FFT Analyzer interface) [237](#)  
   data cursors (Data Logger interface) [173](#)  
   data cursors (FFT Analyzer interface) [195](#)  
 Visible Display column  
   Data Logger interface [183](#)  
   FFT Analyzer interface [231](#)  
 Visible Plot column  
   Data Logger interface [172](#)  
   FFT Analyzer interface [194](#)  
 Visible Statistics column  
   Data Logger interface [188](#)  
   FFT Analyzer interface [237](#)  
 voltage range [129, 131](#)  
 voltage-based sensors parameters [114](#)

## W

- waveform types [142](#)
- weighting factor [214](#), [219](#), [223](#), [226](#)
- white noise [153](#)
- Window tab (FFT Analyzer interface) [63](#)
  - Advanced FFT Analysis option [138](#)
  - FFT Analysis option [137](#)
- windowed time-domain channels, adding [206](#)
- windowing functions
  - Bartlett [137](#), [138](#)
  - Blackman [137](#), [138](#)
  - BlackmanHarris [137](#), [138](#)
  - Exponential [139](#)
  - Flattop [138](#)
  - Hamming [137](#), [138](#)
  - Hanning [137](#), [138](#)
  - rectangular [137](#), [138](#)
- windowing types
  - cosine taper [139](#)
  - force [139](#)
- windows
  - Acquisition Config (Data Logger interface) [56](#)
  - Acquisition Config (FFT Analyzer interface) [59](#)
  - Acquisition Status (Data Logger interface) [84](#)
  - Acquisition Status (FFT Analyzer interface) [84](#)
  - Channel Display [81](#)
  - Channel Plot [68](#)
  - docking [53](#)
  - hiding [54](#)
  - moving [53](#)
  - Plot and Data Config [65](#)
  - resetting [55](#)
  - resizing [53](#)
  - Statistics [82](#)
- Windows menu [48](#)
  - Acquisition Config [48](#)
  - Channel Display [48](#)
  - Channel Plot [48](#)
  - Channel Statistics [48](#)
  - Plot and Data Config [48](#)
  - Reset Windows Layout to Default Layout [35](#), [48](#)
  - Reset Windows Layout to Last Saved [48](#)

## X

- X4 scaling [119](#)
- x-axis
  - format of axis [71](#)
  - gridlines [71](#)
  - lin/log scaling [71](#)
  - precision [71](#)

- scaling [71](#)
- settings [70](#)
- span [123](#), [126](#)
- X-Axis label
  - Data Logger interface [181](#)
  - FFT Analyzer interface [203](#)

## Y

- y-axis
  - format of axis [70](#)
  - gridlines [69](#)
  - lin/log scaling [70](#)
  - precision [69](#)
  - scaling [69](#)
  - settings [69](#)
- Y-Axis label
  - Data Logger interface [181](#)
  - FFT Analyzer interface [203](#)

## Z

- Zoom All to Fit in View Y control [73](#)
- Zoom Box control [75](#)
- Zoom Full Out option [79](#)
- Zoom In X option [79](#)
- Zoom In Y option [79](#)
- zoom options for the current plot [78](#)
- zoom to fit all
  - x-axis [71](#)
  - y-axis [70](#)
- zoom to fit in view, y-axis [70](#)
- Zoom-In All control [73](#)
- Zoom-Out All control [73](#)